



Agilent Technologies
L4532A/34A
20 MSa/s Digitizer

User's Guide

Notices

© Agilent Technologies, Inc. 2009, 2012

No part of this manual may be reproduced in any form or by any means (including electronic storage and retrieval or translation into a foreign language) without prior agreement and written consent from Agilent Technologies, Inc. as governed by United States and international copyright laws.

Manual Part Number

L4534-90001

Edition

Third Edition. March 2013

Printed in Malaysia

Agilent Technologies, Inc.
3501 Stevens Creek Blvd.
Santa Clara, CA 95052 USA

Microsoft® and Windows® are U.S. registered trademarks of Microsoft Corporation.

Software Revision

This guide is valid for the firmware that was installed in the instrument at the time of manufacture. However, upgrading the firmware may add or change product features. For the latest firmware and documentation, go to the product page at:

www.agilent.com/find/L4532A

or

www.agilent.com/find/L4534A

Declaration of Conformity

Declarations of Conformity for this product and for other Agilent products may be downloaded from the Web. Go to <http://regulations.corporate.agilent.com> and click on "Declarations of Conformity." You can then search by product number to find the latest Declaration of Conformity.

Warranty

The material contained in this document is provided "as is," and is subject to being changed, without notice, in future editions. Further, to the maximum extent permitted by applicable law, Agilent disclaims all warranties, either express or implied, with regard to this manual and any information contained herein, including but not limited to the implied warranties of merchantability and fitness for a particular purpose. Agilent shall not be liable for errors or for incidental or consequential damages in connection with the furnishing, use, or performance of this document or of any information contained herein. Should Agilent and the user have a separate written agreement with warranty terms covering the material in this document that conflict with these terms, the warranty terms in the separate agreement shall control.

Technology Licenses

The hardware and/or software described in this document are furnished under a license and may be used or copied only in accordance with the terms of such license.

Restricted Rights Legend

U.S. Government Restricted Rights. Software and technical data rights granted to the federal government include only those rights customarily provided to end user customers. Agilent provides this customary commercial license in Software and technical data pursuant to FAR 12.211 (Technical Data) and 12.212 (Computer Software) and, for the Department of Defense, DFARS 252.227-7015 (Technical Data - Commercial Items) and DFARS 227.7202-3 (Rights in Commercial Computer Software or Computer Software Documentation).

Waste Electrical and Electronic Equipment (WEEE) Directive 2002/96/EC

This product complies with the WEEE Directive (2002/96/EC) marking requirement. The affixed product label (see below) indicates that you must not discard this electrical/electronic product in domestic household waste.

Product Category: With reference to the equipment types in the WEEE directive Annex 1, this product is classified as a "Monitoring and Control instrumentation" product.

Do not dispose in domestic household waste.

To return unwanted products, contact your local Agilent office, or see www.agilent.com/environment/product for more information.



Safety Information

The following general safety precautions must be observed during all phases of operation of this instrument. Failure to comply with these precautions or with specific warnings or operating instructions in the product manuals violates safety standards of design, manufacture, and intended use of the instrument. Agilent Technologies assumes no liability for the customer's failure to comply with these requirements.

Product manuals are provided with your instrument on CD-ROM and/or in printed form. Printed manuals are an option. Manuals are also available on the Web. Go to www.agilent.com/find/manuals and type in your product number in the Search field.

General

Do not use this product in any manner not specified by the manufacturer. The protective features of this product may be impaired if it is used in a manner not specified in the operation instructions.

Before Applying Power

Verify that all safety precautions are taken. Make all connections to the unit before applying power. Note the instrument's external markings described under "Safety Symbols".

Ground the Instrument

The Agilent L4532A/34A is provided with a grounding-type power plug. The instrument chassis and cover must be connected to an electrical ground to minimize shock hazard. The ground pin must be firmly connected to an electrical ground (safety ground) terminal at the power outlet. Any interruption of the protective (grounding) conductor or disconnection of the protective earth terminal will cause a potential shock hazard that could result in personal injury.

Fuses

The Agilent L4532A/34A is provided with an internal line fuse. This fuse is not user accessible.

Do Not Operate in an Explosive Atmosphere

Do not operate the instrument in the presence of flammable gases or fumes.

Do Not Operate Near Flammable Liquids

Do not operate the instrument in the presence of flammable liquids or near containers of such liquids.

Do Not Remove the Instrument Cover

Only qualified, service-trained personnel who are aware of the hazards involved should remove instrument covers. Always disconnect the power cable and any external circuits before removing the instrument cover.

Cleaning

Clean the outside of the instrument with a soft, lint-free, slightly dampened cloth. Do not use detergent or chemical solvents.

Do Not Modify the Instrument

Do not install substitute parts or perform any unauthorized modification to the product. Return the product to an Agilent Sales and Service Office for service and repair to ensure that safety features are maintained.

In Case of Damage

Instruments that appear damaged or defective should be made inoperative and secured against unintended operation until they can be repaired by qualified service personnel.

CAUTION

A CAUTION notice denotes a hazard. It calls attention to an operating procedure, practice, or the like that, if not correctly performed or adhered to, could result in damage to the product or loss of important data. Do not proceed beyond a CAUTION notice until the indicated conditions are fully understood and met.

WARNING

A WARNING notice denotes a hazard. It calls attention to an operating procedure, practice, or the like that, if not correctly performed or adhered to, could result in personal injury or death. Do not proceed beyond a WARNING notice until the indicated conditions are fully understood and met.

Safety Symbols



Earth Ground



Chassis Ground



Risk of electric shock



Refer to manual for additional safety information



Standby Power. Unit is not completely disconnected from AC mains when power switch is in standby position

CAT I

IEC Measurement Category I. Inputs may be connected only to circuits that are isolated from AC mains

Installing the Instrument

Before connecting to power, check the following to ensure it is correct for your application.

- Line Cord

The Agilent L4532A/34A power supply operates in the following line-voltage ranges:

~Line:
100-240 V, 50-60 Hz
(240 VA Max)

No line-voltage switch is required and the internal line fuse is appropriate for all voltages within these ranges. This fuse is not user accessible.

Ensure that the power cord or other emergency disconnect device is readily accessible during operations.

The instrument is ventilated from the front, rear, and left side. Do not obstruct the ventilation holes in any of these locations.

Before connecting a load or device under test, read the operating instructions that begin in chapter 1 of the *User's Guide*.

Intended Use of the Instrument

The Agilent L4532A (2-channel) or L4534A (4-channel) 20 MSa/s, Isolated/Floating 250V, 16-bit Digitizer is intended to be used to digitize waveform signals in electronic-test applications. Each input channel provides an isolated, floating input rated for signals of ± 250 Vpk. The instrument must be connected to the device under test using cables appropriate to the application and voltages present.

The L4532A/34A is intended only for IEC Measurement Category I applications, as defined below.

IEC Measurement Category I Overvoltage Protection

The L4532A/34A has IEC Measurement Category I (CAT I) overvoltage protection. IEC Measurement Category I refers to devices that are isolated from line-voltage mains. Do not connect the inputs of a CAT I instrument to AC line-voltage mains.

WARNING

Do not connect the input channels of the L4532A/34A to AC line-voltage mains. This instrument must be used in CAT I (isolated from mains) applications. Do not use in other IEC Measurement Category (CAT II, CAT III, or CAT IV) applications. Failure to observe these precautions may result in electric shock and serious personal injury.

Protection Limits

The Agilent L4532A/34A provides protection circuitry to prevent damage to the instrument and to protect against the danger of electrical shock, provided the protection limits are not exceeded. To ensure safe operation of the instrument, do not exceed the protection limits shown for each input on the rear panel.

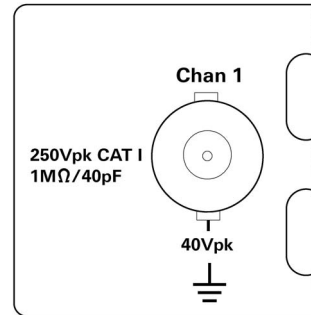

Each input-channel BNC connector (Channel 1 is shown) has the following protection limits:

- The shield of each input-channel BNC connector may float ± 40 Vpk relative to earth ground. Each channel may float independently.
- The allowable input signal is ± 250 Vpk (from shield to center pin on the BNC connector) for each input channel.
- The Transient Overvoltage limit is ± 400 Vpk for each input channel.

The input impedance for each channel is $1 \text{ M}\Omega$ and the input capacitance is 40 pF .

In addition:

- The **10 MHz In** connector is limited to 3 Vpp .
- The **Trig In/Out** connector is limited to $+5 \text{ V max}$.

WARNING

Do not exceed any of the specified protection limits to avoid the risk of electric shock or instrument damage.

Contents

1 Introduction

L4532A/34A Digitizers - Capabilities	2
General Capabilities.....	2
Sampling and Measuring Capabilities	3
L4532A/L4534A Front Panel At A Glance	4
On/Stand-by button.....	4
Display	4
L4532A/L4534A Rear Panel At A Glance.....	5
Channel Connections (left side of rear panel, 4-channel model)	5
Control Connections (center of rear panel)	5
Communications Connections (right side of rear panel)	5
Functional Overview	6
General Operation and Programming	6
Overview of Digitizer Operating States	7
Overview of Acquisition Options	8
General Workflow: Configure, Digitize, Fetch!	9
Configure.....	9
Digitize	10
Fetch.....	10

2 Getting Started

Inspecting Contents	12
Items Supplied	12
Inspecting the Unit.....	12
Installing the L4532A/34A	13
Safety Considerations	13
Environment	13
Rack Mounting the Digitizer	14
Powering Up	18
Connecting the Line Cord	18
Applying Power	18
Power-On Sequence	19
Power-Down Sequence	19
Input Connections	20
Input Characteristics and Protection limits	20
Connecting the DUT	20
Fixture Safety Considerations	21

High Voltage Hazards	21
Connecting to Your PC.....	22
Using the Web Interface	23
Accessing the Web Interface.....	24
Navigating the Web Interface	25
Navigating the Remote Control Page	26
In the Subsequent Chapters.....	31

3 Practical Use Examples

Example 1: Digitizing a Sine Wave	34
Learning Objectives.....	34
Test Setup	34
Digitizing Using Default Settings.....	34
Controlling What Is Displayed	36
Changing Channel Settings	38
Changing Acquisition and Trigger Settings	39
Saving Data to a File	41
Using the On-Board Measurement Feature	43
Example 2: Digitizing a Solenoid Output Driver	47
Learning Objectives.....	47
Test Setup	47
Capturing All Four Solenoid Drives	50
Making a First Measurement of Vpk for all Channels, Using Markers	52
Making a More Accurate Measurement of Vpk	53
Help with Host Application Programming	57
Specifying Different Measurement Windows Using Discrete Measurements	58
Example 3: Digitizing Simultaneous Airbag Deployment Signals.....	62
Learning Objectives.....	62
Test Setup	62
Physical Configuration of Multiple Digitizers	63
Programming To Synchronize Multiple Digitizers.....	64
Before Synchronization.....	64
To Achieve and Verify Synchronization	65
To Re-configure the Trigger Bus	65
Running the Measurement.....	66

4 Digitizer Programming and PC Connection

Programming the Digitizer	68
Introduction to the Command Language	68
Syntax Conventions	69
Parameter Types	70
Numeric Parameters	70
Discrete Parameters	70

Boolean Parameters	70
ASCII String Parameters	70
The Channel and Channel List Parameters	71
Querying Parameter Settings	71
VERBoSe Queries	72
IEEE-488.2 Common Commands	72
Command Terminators	72
Parameter Coercion	73
Settings Conflicts	73
Stale Data Errors	74
What Causes Stale Sample Data	74
What Causes Stale Measurement Data	74
Connecting the L4532A/34A to Your Computer	75
Connecting over USB	75
Connecting over LAN	75
Selecting a LAN Network	76
Private LAN Considerations	76
Site LAN Considerations	77
Configuring a LAN Interface	77
Communicating over the LAN	88
Using Telnet	88
Using Sockets	88

5 Understanding Key Concepts

Digitizer Operating States	90
Operating States Diagram	91
The Stand-By State	92
The Idle State	92
The Calibrating State	93
The Self-Test State	94
The Acquisition State	95
The Wait for Arm State	96
The Armed State	97
The Wait For Trigger State	98
The Triggered State	99
The On-Board Measurement State	100
The Data Transfer State	101
Basic Configuration Concepts and Choices	102
Data Records	103
A Typical Data Record	103
Selecting the Number of Records, Arm and Trigger Events Per Acquisition ..	105
Sample Rate	106
Sample Rate Choices	106
Implications of Your Sample Rate Selection	106
Minimum Suggested Sample Rate	107
Channel-Specific Parameters	108

Range and Resolution	108
Signal Coupling	109
Low-Pass Filter	109
Overvoltage Protection	110
Arming and Triggering Concepts and Choices	111
Selecting an Arming Source	111
Immediate Arming	111
Software Arming	112
External Arming	112
Timed Arming	113
Selecting a Triggering Source	114
Immediate Triggering	114
Software Triggering	115
External Triggering	115
Channel Edge Triggering	116
Window Triggering	117
“OR” Triggering	119
Trigger Timing	120
Impacts on Trigger Timing	120
Case 1: A Single Record Acquisition; Sample 0 is Taken At the Trigger Event .	122
Case 2: Introducing Trigger Timestamp Latency:	123
Case 3: Introducing Trigger Delay:	124
Case 4: Introducing Inter-Record Re-Arm Time and Implicit Trigger Holdoff: .	125
Case 5: Introducing the User-Configured Minimum Trigger Holdoff:	126
Data Retrieval Concepts and Choices	127
Selecting a Data Retrieval Format	128
ADC16, The Digitizer’s Native Storage Format	128
The Integer ADC16 Return Format	129
The Integer ASCII Return Format	130
The Real 32 Return Format	131
The Real 64 Return Format	132
The Real ASCII Return Format	133
Selecting the Byte Order for Returned Binary Data	134
Selecting Which Command To Use for Returning Sample Data	135
When to Use a FETCH Query	135
When to Use a READ Query	135
Which FETCH or READ Query to Use	135
Selecting Which Sample Data to Return	136
Parameter Choices for Data Return	136
Data Return Without Decimation	137
Data Return Using the Decimation Feature	138
DATA Decimation	138
AVERage Decimation	139
MINMax Decimation	140
Understanding the Returned Data: Bytes, Blocks, and Lists	141
Data Returned Via the Host Application	141
The Data Block Header	141
Structure of the Return Data Block or List	142
Data Returned Via the Web Interface	143

6 Detailed Configuration and Operating Instructions

Configuring the Digitizer	146
Configuring Channel Attributes	147
Channel Overvoltage Protection	147
Configuring Acquisition (Sampling and Record Storage) Attributes	148
Configuring the Arm and Trigger Sources	149
Configuring the Arming source	149
Setting the External Arm Signal's Slope	149
Setting the Arm Timer	149
Configuring the Trigger Source	150
Setting the External Trigger Signal's Slope	150
Configuring Edge Trigger Attributes	151
Configuring Window Trigger Attributes	152
Turning Channel Triggering OFF	153
Querying Channel Trigger Mode	153
Configuring External Trigger In/Out Connector Parameters	154
Connector Pulse Specifications	154
Configuring the Trigger-In Slope	155
Configuring the Trigger-Out Attributes	155
Equivalent Circuits Resulting from Configuring the Trig In/Out Connector ...	156
Configuring Trigger Timestamp Mode	157
Acquiring and Transferring Data	158
Overview of Simplified Data Acquisition	158
Overview of Comprehensive Data Acquisition	158
The Complete Data Retrieval Process:	159
Retrieving Sample Data Using the FETCH Queries	161
Retrieving Sample Data as ADC Codes	162
Retrieving Sample Data as Voltage Levels	163
Retrieving Record Summary Information	164
Retrieving Sample Data Using the READ Queries	167
Synchronizing Multiple Digitizers	168
Making On-Board Measurements	169
Comparing Installed and Discrete Measurements	170
Installed Measurements	170
Discrete Measurements	170
How the L4532A/34A Derives Calculated Measurements	171
The Measurement Histogram	171
How Voltage Levels Are Calculated	172
How Time-Based Measurements are Calculated	174
Manually Specifying Measurement Parameters	180
Specifying a Measurement Window	181
Selecting the Method for Setting Top and Base Levels	182
Specifying Absolute Top and Base Levels	182
Selecting the Method for Setting Threshold Levels	183
Specifying Percentage Threshold Levels	184
Specifying Absolute Threshold Levels	185
Resetting Default Top, Base and Threshold Levels	186

Making Measurement Queries	187
Calculating VMAX	188
Calculating VMIN	188
Calculating VPP	188
Calculating VAMPLitude	188
Calculating VTOP	188
Calculating VBASE	188
Calculating VUPPer	189
Calculating VMIDdle	189
Calculating VLOWer	189
Calculating VRMS	189
Calculating PWIDth	190
Calculating NWIDth	190
Calculating RISE:TIME	190
Calculating FALL:TIME	190
Calculating RISE:PERiod	191
Calculating FALL:PERiod	191
Calculating RISE:FREQuency	191
Calculating FALL:FREQuency	191
Calculating RISE:DUTYcycle	192
Calculating FALL:DUTYcycle	192
Calculating RISE:OVERshoot	192
Calculating FALL:OVERshoot	192
Calculating RISE:PREShoot	193
Calculating FALL:PREShoot	193
Installed Measurements	194
Defining an Installed Measurement	194
Querying the Results of Installed Measurements	195
Deleting an Installed Measurement	196
Re-Running Installed Measurements	196
System-Related Operations	197
Configured Instrument States	198
Parameter Default Values	198
Saving an Instrument Configuration State	201
Recalling a Saved Instrument Configuration State	201
Display Features	202
Top Display Line	202
Bottom Display Line	203
Displaying Custom Text	204
Turning the Display Off (or back On)	204
Potential Display Problems.....	204
Self Test	205
Self-Test Procedure	206
Calibration	207
Auto-Zero Calibration	207
Instrument Conditions	208
The Status System	208
Error Messages	208
Safe State	208
Secure State	209

7 Specifications

General Specifications	212
Arm and Trigger	213
Sampling	213
DC Accuracy	214
Dynamic Characteristics	215
Timing and synchronization	216
Waveform memory	216
Waveform measurements	216
Utilities	216
Hardware	217
Software	217
Minimum system requirements (I/O Libraries and Drivers)	218
Environmental	218
Data storage/transfer	218
To Calculate Total Measurement Error.....	219



1 Introduction

This chapter provides an overview of the basic capabilities of the L4532A/34A digitizers, annotated at-a-glance views of the front and rear panels, and a functional overview.

The overview section introduces your options for programming and controlling the digitizer. Reading this section first provides a quick road-map to the rest of this User's Guide.

L4532A/34A Digitizers - Capabilities 2

General Capabilities 2

Sampling and Measuring Capabilities 3

L4532A/L4534A Front Panel At A Glance 4

On/Stand-by button 4

Display 4

L4532A/L4534A Rear Panel At A Glance 5

Channel Connections (left side of rear panel, 4-channel model) 5

Control Connections (center of rear panel) 5

Communications Connections (right side of rear panel) 5

Functional Overview 6

General Operation and Programming 6

Overview of Digitizer Operating States 7

Overview of Acquisition Options 8

General Workflow: Configure, Digitize, Fetch! 9



L4532A/34A Digitizers - Capabilities

General Capabilities

The L4532A (2-channel) and L4534A (4-channel) are 1U, full-rack (EIA cabinet), LXI (Class-C) digitizers for design validation and functional test applications. Primary features of both models are:

- **Maximum Input Voltage:** ± 250 V
- **Minimum Full-Scale Voltage Range:** ± 250 mV (1000:1 range)
- **Isolated/Floating Inputs:** two or four differential inputs; can measure high and low voltage signals simultaneously on separate channels
- **Maximum Sample Rate:** 20 MSa/s
- **Vertical Resolution:** 16 bits (including sign bit)
- **Analog Bandwidth:** 20 MHz
- **Input Filters:** 200 kHz, 2 MHz and 20 MHz
- **Power Supply:** Universal, 100 V to 240 V
- **BNC connectors for:**
 - Input channels
 - Bi-directional external trigger In/Out
 - 10 MHz external synchronization source (clock) input and output
 - Calibration source output
- **Sample Memory:**
 - Standard Memory: 32 MSa/channel (not upgradeable after purchase)
 - Deep Memory Option: 128 MSa/channel
- **Instrument Control (PC interface) Options:**
 - Gigabit LAN (with auto-IP or user-set parameters)
 - USB 2.0
- **Programming Language:** ASCII commands, IEEE 488.2 compliant
- **Computer Interfaces:**
 - Built-in Web Interface (LAN only)
 - LAN: Standard LAN 10/100/1000BaseTx, (VXI-11 Class-C* compliant), Sockets (service at port 5025), Telnet** (service at port 5024)
 - * VXI-11 allows transfer of IEEE 488.1 and IEEE 488.2 messages over a TCP/IP network. Supported by Agilent IO Library Suite (included)
 - ** Telnet service allows transfer of Agilent digitizer commands and responses over a TCP/IP network.
 - USB: Standard USB 2.0 (USBTMC*** compliant)
 - *** USB Test and Measurement Class (TMC) that communicates over USB, complying with IEEE 488.1 and IEEE 488.2 standards. Supported by Agilent IO Libraries Suite (included)
 - IVI-C, IVI-COM, and LabVIEW drivers

Sampling and Measuring Capabilities

The digitizer captures one data record (a selected number of samples) per trigger, and stores it in sample memory. You can query the digitizer to download data from the sample memory, and you can specify:

- Individual channels or ranges of (one, two or four) channels; four channels on L4534A only)
- Individual samples or ranges of samples
- Individual records or ranges of records
- All samples in memory

The digitizer can calculate the following measurements from the sample data:

- Voltage levels
 - minimum voltage
 - maximum voltage
 - peak-to-peak voltage
 - base voltage
 - top voltage
 - amplitude
 - average value
 - RMS average
 - lower threshold level
 - middle threshold level
 - upper threshold level
- Time-based measurements
 - rise time
 - fall time
 - pulse width
 - period
 - duty cycle
 - frequency
 - preshoot
 - overshoot

L4532A/L4534A Front Panel At A Glance

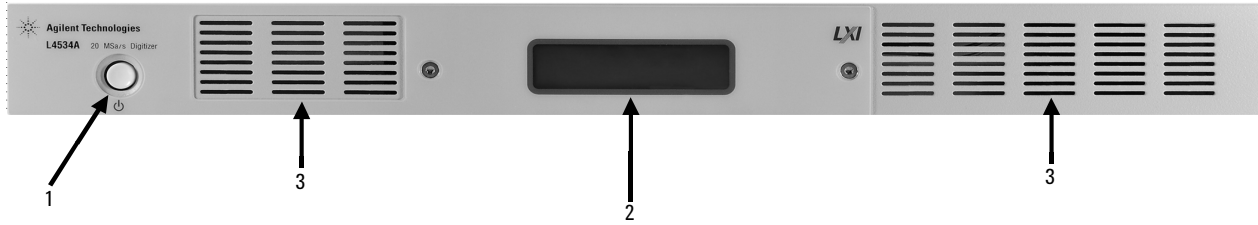

1	On/stand-by button
2	Display
3	Air vents

On/Stand-by button

The “on/stand-by” button (⏻) turns on the digitizer if it is in stand-by mode, and returns it to stand-by mode if it is on. Complete details of the button’s function are in [“Applying Power”](#) on page 18.

Display

The backlit front-panel LCD display provides two lines which can display 16 characters each. The top line displays the instrument state; the bottom line displays LXI/LAN information, firmware update progress messages, or an LXI error indicator. Complete details of what the display states convey and commands to control the display are in [“Display Features”](#) on page 202.

A sequence of instrument ID information is displayed at power-on, followed by a fixed idle state message. The complete sequence is illustrated in [“Applying Power”](#) on page 18.

L4532A/L4534A Rear Panel At A Glance

The photographs below show the 4-channel model L4534A. The 2-channel model L4532A has only two BNC connectors for Chan 1 and Chan 2 at left; all other connections are the same on both models.



Channel Connections (left side of rear panel, 4-channel model)

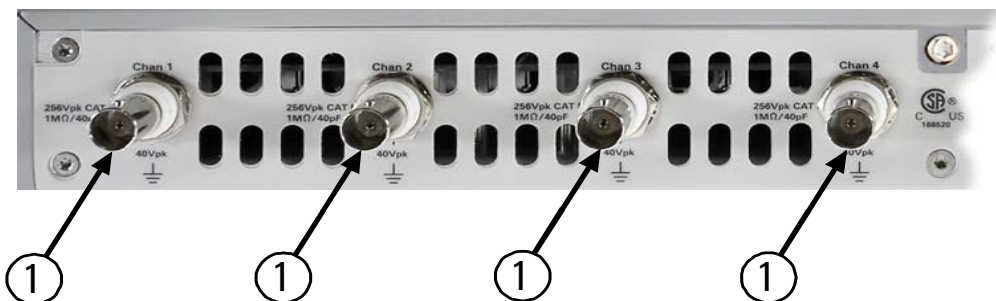

Control Connections (center of rear panel)

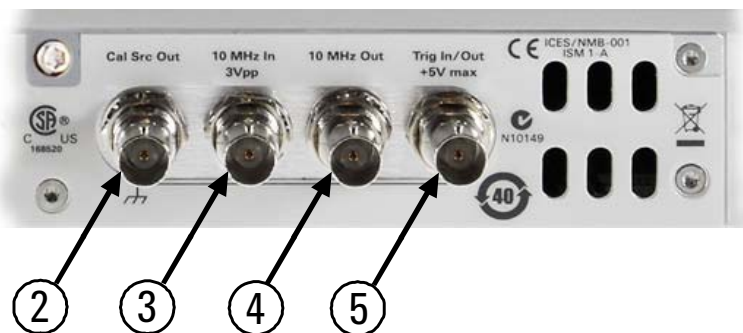

Communications Connections (right side of rear panel)

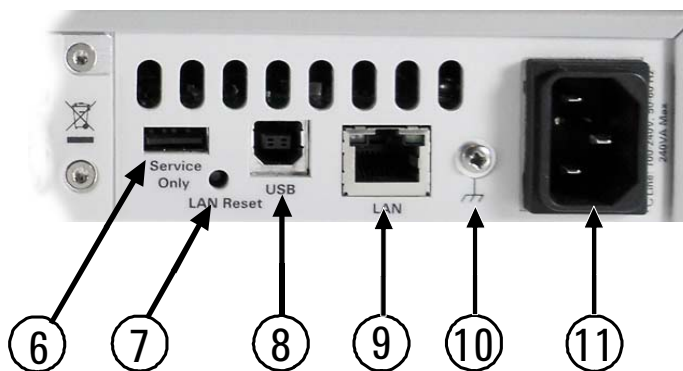

1	BNC connectors for channel inputs
2	BNC connector for calibration source
3	BNC connector for 10 MHz reference clock input
4	BNC connector for 10 MHz reference clock output
5	BNC connector for trigger signal
6	Service port (see service guide for use)
7	LAN reset access port
8	USB communication port
9	LAN communication port
10	Chassis ground terminal
11	AC power cable socket

Functional Overview

The L4532A/34A digitizer provides many flexible workflow options, depending on your needs. Read this section first to familiarize yourself with these options; the overview provides links to the discussion of specific functions provided elsewhere in this User's Guide.

General Operation and Programming

Typically, you will design an integrated test system using the digitizer in conjunction with signal sources, transducers, measurement devices, and computers to test the response of a device to input signals. The digitizer captures analog input signals during the test, converts them to digital form and stores the digital output for retrieval and post processing.

The L4532A/34A digitizer has no front-panel controls other than the “on/stand-by” button (⏻). You operate it remotely over a computer interface. See [“Connecting to Your PC”](#) on page 22 to establish that interface. Once connected, you control the digitizer using the following methods:

- Using the digitizer’s built-in Web Interface, you can control the instrument over a Local Area Network (LAN). You can configure the instrument, collect and display data, and perform many other tasks without programming.

This is the most user-friendly way to familiarize yourself with digitizer operation, useful during test system design and validation. See [“Using the Web Interface”](#) on page 23 for an introduction to the Web Interface.

- Using an ASCII-based instrument command language written for the L4532A/34A digitizers, you can control the digitizer over a LAN or USB connection. By integrating the digitizer commands into your system test program, you can fully automate digitizer configuration, data collection, storage, and analysis.

This is the fastest way to operate the digitizer, useful during production testing. The command language is used throughout this manual; see [“Programming the Digitizer”](#) on page 68 for an overview of the language and its use. Complete syntax rules and examples can be found in the *Agilent L4532A/34A Command Reference*.

- Using IVI-C, IVI-COM, and LabVIEW drivers.

In practice, you may choose a different workflow during test system design than in production. During the design phase, you may choose to run individual tests, alter configuration settings, analyze the output, and use the digitizer’s built-in measurement capabilities. These tasks are easily done using the Web Interface. In production, you may optimize workflow for speed of data throughput, and would more likely build a comprehensive test program to be managed by your host application.

Overview of Digitizer Operating States

Familiarize yourself with these digitizer *operating states*, as they are used throughout the User's Guide to describe digitizer functions.

- Stand-by (the digitizer is powered-down)
- Idle (the digitizer is powered-up and ready to receive commands)
- Acquisition (the digitizer is initiated and acquiring data). This state encompasses four sub-states:
 - Wait for Arm (the digitizer is initiated and waiting for the trigger to be armed)
 - Armed (an arm event has been recognized)
 - Wait for Trigger (the digitizer is initiated, armed, and waiting for a trigger)
 - Triggered (a trigger event has been recognized)
- On-Board Measurement (an on-board measurement is in progress)
- Data Transfer (data is being retrieved – or fetched – from sample memory)
- Calibrating (the digitizer is performing a calibration)
- Self Test (the digitizer is executing a self-test)

Beginning on [page 90](#), “[Digitizer Operating States](#)” provides a complete discussion of these operating states, illustrates general digitizer process flow and explains what functions can be performed when the digitizer is in each state.

Overview of Acquisition Options

The L4532A/34A digitizer is more flexible than most digitizers in current use, in that they provide independent configurable controls for arming and triggering. The default settings allow you to begin digitizing as easy as Connect, Initiate, Fetch. But for more sophisticated testing programs, you'll need to understand your choices and their implications for trigger timing before configuring the instrument.

Continuous Sample Acquisition: When initiated, the digitizers sample continuously at the maximum sampling rate of 20MSa/s. Your selection of configurable acquisition parameters determines how many of these samples are stored, the precise moment a trigger event occurs, and how many pre-trigger and post-trigger samples constitute each data record. With these settings you control record size, acquisition and data transfer speed to suit your needs.

Arming: Think of *arming* as a gating function, allowing you to provide timed, programmed or synchronized control of one or more digitizers, readying them for accepting a trigger or series of triggers. You can configure immediate arming (the default and simplest method—in effect, an open gate), or arm using software commands, an externally applied arm pulse or send a series of timed arms.

Triggering: Think of *triggering* as the event which controls when each record is acquired. You can configure immediate triggering (the default and simplest method), or trigger using software commands, an externally applied trigger pulse or a trigger based on the signal applied to one of the digitizer's input channels. For high channel count applications, you can synchronize multiple L4532A/34A digitizers to simultaneously trigger and measure many signals.

Record Size: Regardless of which arm and trigger methods you select, you can specify how many pre-trigger and post-trigger samples to take per trigger event, and specify how many triggers to accept per arm event, up to the memory capacity of the digitizer.

Beginning on [page 111](#), “Arming and Triggering Concepts and Choices” provides a complete discussion of arming and triggering methods and explains all user-configurable arming and triggering parameters

Beginning on [page 120](#), “Trigger Timing” illustrates trigger process flow and explains the implications of trigger delay and trigger holdoff on trigger timing and sampling.

General Workflow: Configure, Digitize, Fetch!

Regardless of the specific digitizer functions or control methods you use, your workflow will encompass these basic steps:

- 1 Configure (optional, as you may choose to use default settings)
- 2 Digitize
- 3 Fetch

These are briefly introduced below.

Configure

Before sampling, you may configure the digitizer (using non-default settings) for the type of input signals you anticipate and the type of sample data you wish to acquire. You can selectively sample and store only the data you need, to get the right data faster.

The configuration options primarily include:

- acquisition attributes—these define the data records you will acquire, sampling rate and trigger timing;
- channel attributes, specific to the digitizer's input channels;
- arm and trigger source parameters that define the events which trigger the digitizer;
- format choices for the data returned when you retrieve sample data and send measurement queries.

[Chapter 5](#), “Understanding Key Concepts” explores these configuration options. [Chapter 6](#), “Detailed Configuration and Operating Instructions” provides additional detail for using each of the commands in the CONFigure and FORMat subsystems.

Digitize

The digitizer is readied for sampling by being initiated and armed. The armed digitizer acquires one pre-configured record of digitized samples when triggered. *Digitize* encompasses three distinct processes:

- Initiate (from the Idle state, initiating the digitizer prepares it to respond to an arm event).
- Arm (from the Wait for Arm state, arming commands the digitizer to collect a pre-configured number of pre-trigger samples, stored in a circular buffer, and prepares it to respond to a trigger event).
- Trigger (from the Wait for Trigger state, triggering commands the digitizer to collect a record including the pre-trigger samples and a pre-configured number of post-trigger samples).

The digitizer provides a wealth of control options for arming and triggering, depending on your needs. With all combinations of arm and trigger methods, you can specify how many pre-trigger and post-trigger samples to take per trigger event, and specify how many triggers to accept per arm event, up to 1024 or the memory capacity of the digitizer.

[Chapter 5](#), “Understanding Key Concepts” explores these arming and triggering options. [Chapter 6](#), “Detailed Configuration and Operating Instructions” provides additional detail for using each of the commands that configure and control arming and triggering.

Fetch

Once records are written and the digitizer returns to the Idle state, you may *fetch*—or retrieve—the digitized records from sample memory.

The digitizer provides many options for retrieving data, allowing you to specify all or specific records, all or specific data from each record, and record summary data.

[Chapter 5](#), “Understanding Key Concepts” explores the options for record and sample data retrieval. [Chapter 6](#), “Detailed Configuration and Operating Instructions” provides additional detail for using each of the commands that configure and control data retrieval.

For pure speed, you may wish to configure the digitizer for maximum throughput and fastest data retrieval, specifying only the decimated data you actually need. You would make any needed measurements from that data using applications on your PC, after retrieval is complete.

The digitizer also offers On-Board Measurement capabilities, as outlined on [page 3](#). Beginning on [page 169](#), “[Making On-Board Measurements](#)” provides a complete discussion of these measurements, explains why you would want to install specific measurements for immediate processing after acquisition is complete, illustrates the measurements using a typical waveform, and provides an overview of MEASurement command syntax.



2 Getting Started

This chapter gets you started using the L4532A/34A digitizer. It provides basic instructions for initial contents inspection, safety considerations, installation, input signal connections, and communication between the digitizer and your PC. Then it introduces the digitizer's built-in, LAN-based Web Interface, so you can follow perform the first example in Chapter 3.

Inspecting Contents 12

- Items Supplied 12
- Inspecting the Unit 12

Installing the L4532A/34A 13

- Safety Considerations 13
- Environment 13
- Rack Mounting the Digitizer 14

Powering Up 18

- Connecting the Line Cord 18
- Applying Power 18

Input Connections 20

- Input Characteristics and Protection limits 20
- Connecting the DUT 20

Connecting to Your PC 22

Using the Web Interface 23

- Accessing the Web Interface 24
- Navigating the Web Interface 25

In the Subsequent Chapters... 31



Inspecting Contents

Items Supplied

The following accessories are shipped standard with the L4532A/34A digitizer:

- Power cord for country of destination
- *Agilent Automation Ready CD* (IO Libraries Suite)
- *Agilent L4532A/34A Product Reference CD*

The following printed (hardcopy) manuals are optionally available with the L4532A/34A:

- *Agilent L4532A/34A User's Guide*
- *Agilent L4532A/34A Service Guide*

If the L4532A/34A was ordered with option 0B0 (delete printed manuals), hardcopy manuals are not included with the instrument. However, all manuals, online help, and other documentation are provided in electronic form on the *Agilent L4532A/34A Product Reference CD*.

Before installing the instrument, verify that you have received these items with your instrument. If anything is missing, please contact your nearest Agilent Sales Office.

Inspecting the Unit

When you receive your digitizer, inspect it for any obvious damage that may have occurred during shipment. If there is damage, notify the shipping carrier and nearest Agilent Sales Office immediately.

Until you have verified that the digitizer is functional, save the shipping carton and packing materials in case the unit has to be returned.

Installing the L4532A/34A

Safety Considerations

The digitizer is a Safety Class 1 instrument, which means it has a protective earth terminal (the third terminal safety ground in the power connector). That terminal must be connected to earth ground using the supplied three-wire power cord, which must be connected to a grounded receptacle. Do not defeat the safety ground by removing the power plug's ground prong or by using an ungrounded adapter or cable.

Refer to the Safety Summary page at the beginning of this guide for general safety information. Safety warnings for specific procedures are located at appropriate places throughout this manual.

Environment

WARNING

Do not operate the digitizer in the presence of ignitable gases or fumes

The dimensions and environmental conditions for the digitizer are documented in [Chapter 7](#), "Specifications". The digitizer should only be operated indoors in a controlled environment.

Fans cool the digitizer by drawing air through the front and exhausting it out the left side and back. Install the digitizer in a location that allows generous space at the front, back, and left side of the unit for adequate air circulation.

Rack Mounting the Digitizer

CAUTION

Do not block the air intake and exhaust at the front, rear, and left side of the unit. Use the Rack Mount kit (order part # L4532-67001) to rack mount your instrument. Do not use support rails, as these would block air flow.

The L4532A/34A digitizer can be mounted in a 19-inch EIA rack cabinet. It fits in one rack unit (1U) of space. The *optional* L4532-67001 rack mount kit includes the following parts:

Description	Quantity
Clip nut	10 (9 plus 1 spare)
Front Ear	2
Rear Extender Support	2
Rear Ear	2
M3 x 8mm machine screw	10 (8 plus 2 spares)
10-32 Plain Machine Screw	6 (5 plus 1 spare)
10-32 Dress Machine Screw	6 (4 plus 2 spares)

Install the rack mount kit as instructed on the following page. The numbers on the diagram below match the procedure steps.

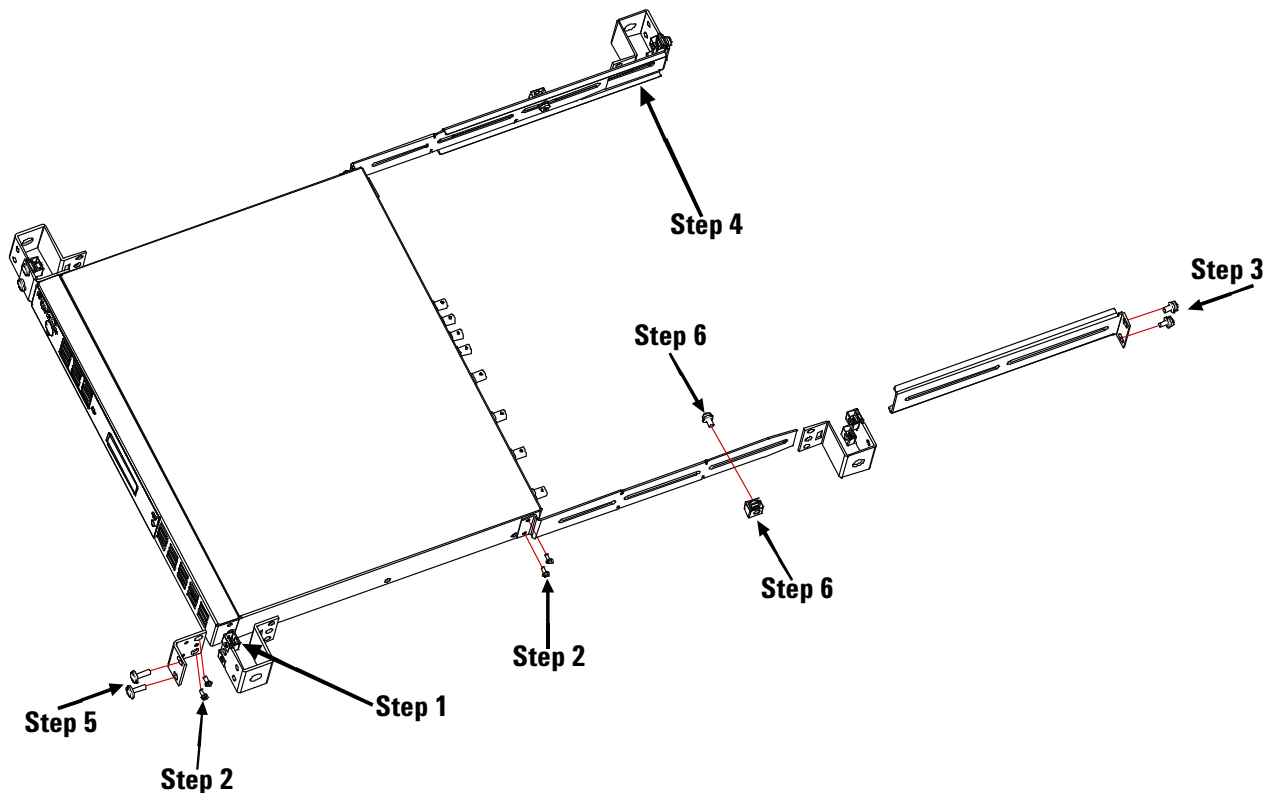

- 1 Install eight clip nuts on the rack frame (two in each corner) where your instrument will be located.

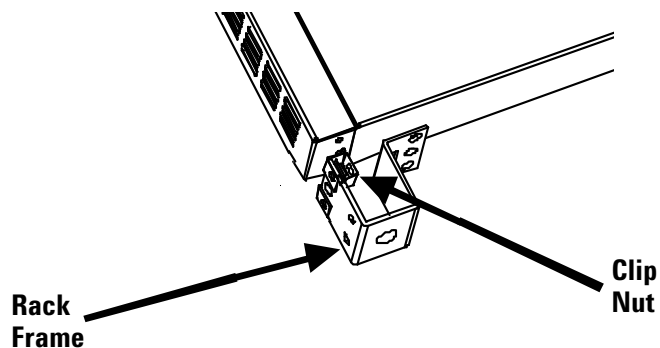

- 2 Attach the two front ears and the two rear extender supports to the digitizer as shown below. Use four M3 x 8mm screws for the front ears and four M3 x 8mm screws for the extender supports.

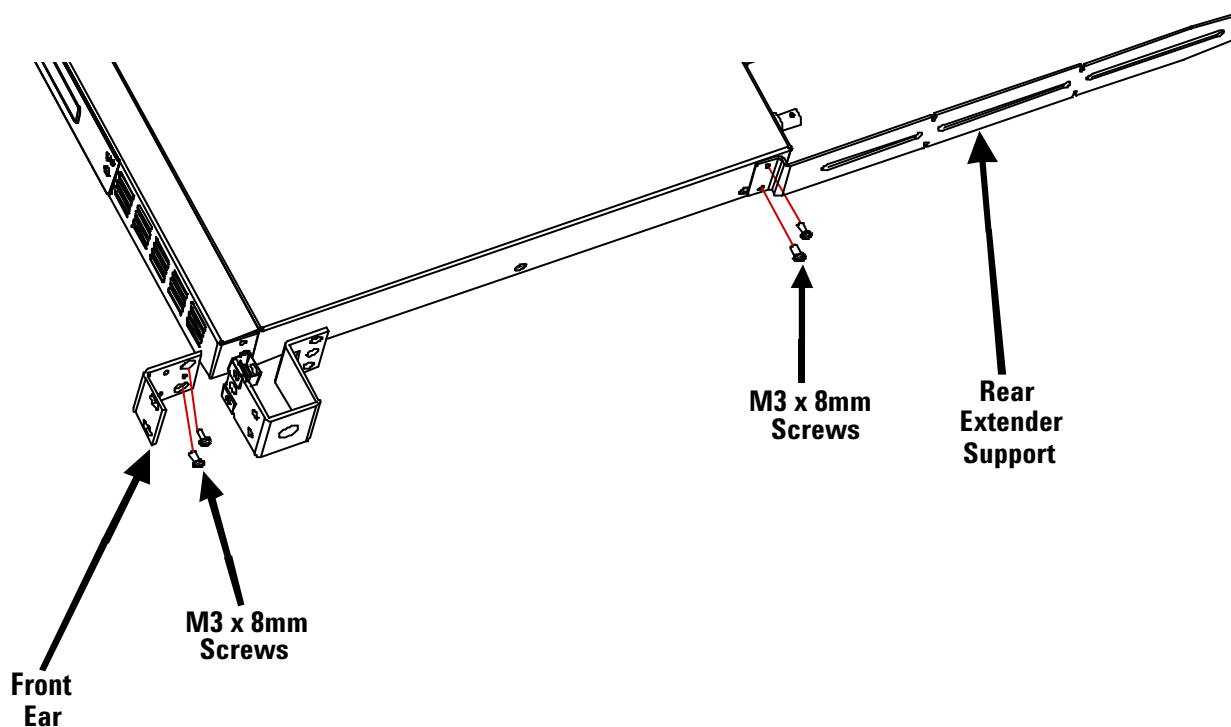

- 3 Attach the two rear ears to the clip nuts on the back of the instrument rack as shown below. Use the four plain 10-32 screws to install the rear ears.

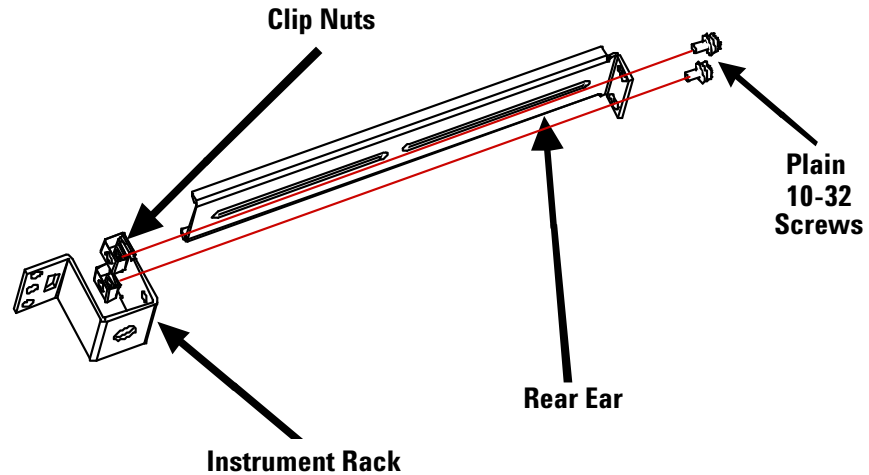

- 4 Slide the instrument into the rack, making sure that the rear extender supports are aligned inside the rear ears.

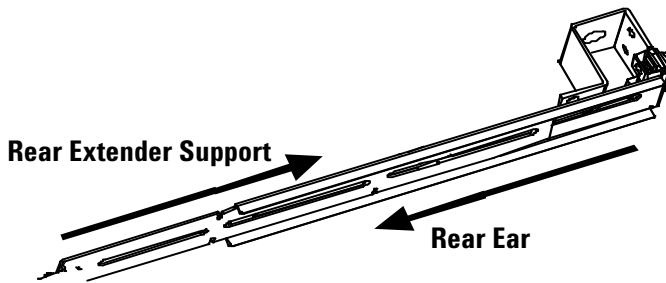

- 5 Attach the front ears to the clip nuts on the front of the instrument rack using the four dress 10-32 screws provided.

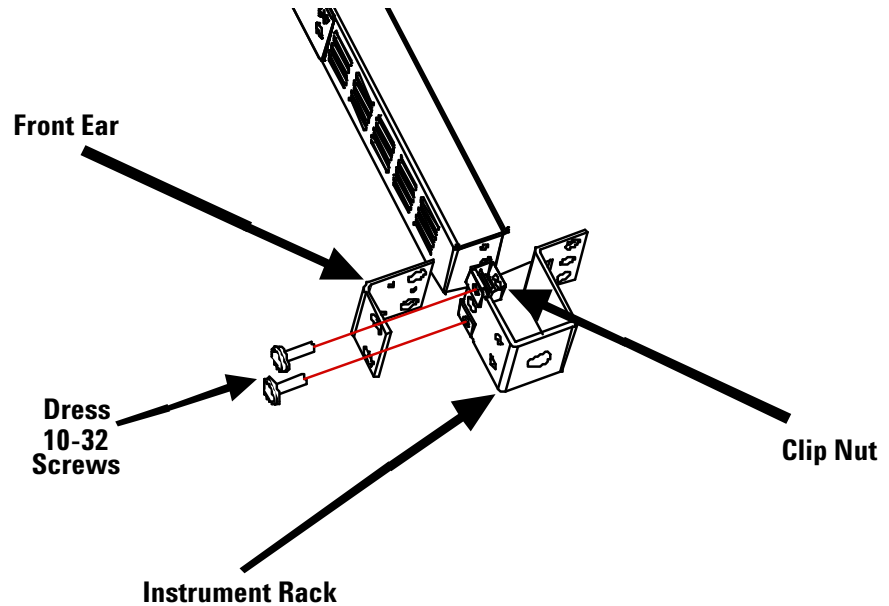

- 6 *Optional step:* Insert two plain 10-32 screws, one through the slot of each rear ear and extender support. Attach the screws with clip nuts.

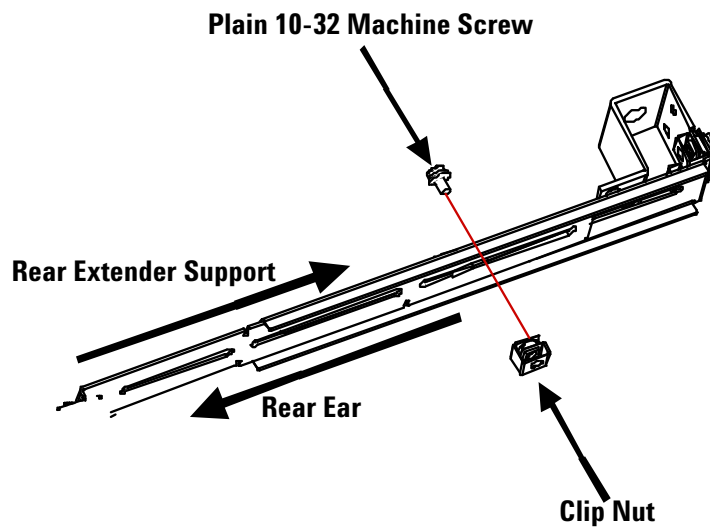

This will prevent the unit from sliding out of the front of the rack.

Powering Up

Connecting the Line Cord

WARNING

FIRE HAZARD Use only the power cord that was supplied with your instrument. Using other types of power cords may cause overheating of the power cord, resulting in fire.

SHOCK HAZARD The power cord provides a chassis ground through a third conductor. Be certain that your power outlet is of the three-conductor type with the correct pin connected to earth ground.

Connect the power cord to the power receptacle on the rear of the unit. If the wrong power cord was shipped with your unit, contact your nearest Agilent Sales Office.

The AC input on the back of the digitizer is a universal AC input that accepts nominal line voltages in the range of 100 VAC to 240 VAC at 100 VA. The line frequency may be either 50 Hz or 60 Hz.

NOTE

The detachable power cord may be used as an emergency disconnect device. In rack installations or other installations with a master power switch for the rack or bench, the master switch may be used as an emergency disconnect device. Do not position the digitizer so that the power cord, master switch or other emergency disconnect device is inaccessible.

Applying Power

With power connected, the unit is in “stand-by” mode. In stand-by mode, line power continues to drive the digitizer’s internal power supply; however, no power is provided to its measurement circuitry.

You may already have connected your LAN or USB interface cable; if not, you may do so at this time.

Press the “on/stand-by” button (⏻) on the front panel. The power on sequence is described and illustrated below.

- If the digitizer does not turn on when ⏻ is pressed, verify that AC power is available to it and that the power cord is securely connected. If it still does not turn on, the cooling fan is not audible, or the front panel display is off when power is applied, return the unit to Agilent for repair.
- The digitizer remembers its power state (e.g. “on” or “standby”) when unplugged; it will return to that state when plugged in again.

Power-On Sequence

The digitizer may take up to a minute to boot, during which you will see some progress messages on its display. Then the display provides three sets of information, in sequence:

ID and revision message First, the instrument will provide an ID and version info (typical example shown):

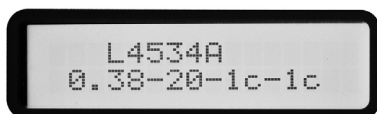

The first line displays the model number. The second line is in the form **f.ff-bb-gg-rr**, where:

- **f.ff** is the instrument's installed firmware version.
- **bb** is the FPGA version for the digitizer's digital board.
- **gg** is the FPGA version for the digitizer's channel 1-2 analog board.
- **rr** is the FPGA version for the digitizer's channel 3-4 analog board.

The FPGA versions provide useful information for instrument servicing.

MAC Address Then, the instrument will display its fixed MAC address (a typical example is shown; every LAN instrument has a MAC address uniquely identifying its LAN interface):



Idle State Message Upon completing the power-on sequence, the instrument displays this idle state message. If a LAN connection is established, the instrument also displays the IP address:

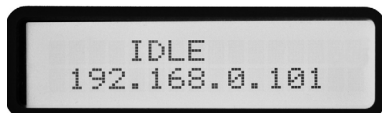

In LAN configurations without a DHCP server, allow approximately 60 seconds for the Automatic IP feature to assign an IP address to the digitizer.

A brief power-on self-test occurs automatically during power-on. If this test fails, the  annunciator on the right side of the display turns on when the digitizer enters the Idle state. In that case, you may initiate a more complete self test as described in “Self Test” on page 205.

Should an LXI LAN fault condition occur, there will be an asterisk  beneath the error annunciator, on the second display line, as follows: *

Power-Down Sequence

To return the instrument to stand-by mode, press .

Input Connections

The L4532A has two input-channel terminals; the L4534A has four (they are shown in “Channel Connections” on [page 5](#)).

Input Characteristics and Protection limits

Each input-channel BNC connector has the following characteristics:

- The input resistance is 1 M Ω .
- The input capacitance is 40 pF.
- The allowable input signal is ± 250 Vpk (from shield to center pin on the BNC connector).
- The Transient overvoltage limit is ± 400 Vpk for each input channel.
- Each channel may float independently; its BNC connector shield may float ± 40 Vpk relative to earth ground.

WARNING

The shields of any two channels must be limited to a potential difference of ± 42 Vpk (maximum, shield-to-shield) to avoid an electric shock hazard.

Connecting the DUT

Use standard BNC cables to connect your device under test (DUT) to the digitizer’s input channels. Such cables have BNC connectors at each end, requiring that the DUT have BNC outputs.

WARNING

When connecting the BNC input connectors to the device under test, make sure that the BNC cables used are rated for the expected input voltages. Up to 250 Vpk may be measured on each channel, provided the cables are rated for such voltages.

The L4532A/34A is designed for IEC Measurement Category I (CAT I) measurements only. The input channels may be connected only to circuitry that is isolated from AC Mains.

WARNING

Do not connect the input channels of the L4532A/34A to AC line-voltage mains. This instrument must be used in CAT I (isolated from mains) applications. Do not use in other IEC Measurement Category (CAT II, CAT III, or CAT IV) applications. Failure to observe these precautions may result in electric shock and serious personal injury.

When any DUT is connected, it can expose the digitizer’s hardware to excessive voltages. The channel protection relays protect the digitizer from these conditions, but only if the digitizer is On. Using the On/Stand-by switch to put the unit in Stand-by mode resets all channels to the ± 256 V range and disconnects the input BNCs from the measurement hardware.

CAUTION

If you remove line power from the digitizer before putting the digitizer in Stand-by mode, the input channel configuration will remain at the last set range, without benefit of input channel overvoltage protection. Agilent recommends that you issue the `SYSTEM:PRESet [SAFE]` command before removing line power (see “Safe State” on [page 208](#)).

Fixture Safety Considerations

The information presented below is a guideline and not an absolute rule. The test system designer must take responsibility for making sure that test programs, systems, and fixtures pose no safety hazard to test operators.

Some safety elements to consider before building a fixture are listed below. There may be others to consider based on local statutes and practices, and the nature of the tests being performed.

High Voltage Hazards

Voltage values equal to or exceeding the following levels (with respect to chassis ground) are considered to be shock hazards:

60 VDC
42 Vpk
30 Vrms

If a hazardous voltage present on your fixture or DUT is accessible to operators, you should provide a safety shroud. You should also warn operators of the danger with a high-voltage warning label.

For the L4532A/34A, there are three main considerations regarding high voltage safety:

- 1 Make sure that all BNC cables being used are rated for the expected voltages.
- 2 Make sure that the DUT does not have high voltage (greater than 42 Vpk) circuits exposed to the operator.
- 3 Make sure that floating shields on two or more channels do not float at a shield-to-shield potential exceeding 42 Vpk. Otherwise, a shroud should be used.

WARNING

If the shields of two or more channels are expected to float with more than a 42 Vpk potential difference between shields, operators must be protected against the resulting shock hazard. A shroud or cover must be provided to prevent contact with the shields during such operations. Failure to do so may result in electric shock.

Connecting to Your PC

You may connect the digitizer to your PC using a local area network (LAN) or USB interface. Complete connectivity details for Agilent instruments can be found in the *Agilent GPIB/USB/LAN Connectivity Guide*, provided on the *Agilent IO Libraries CD*.

The L4532A/34A has a built-in web server. The LAN connection between the PC and the digitizer provides access to the digitizer through the digitizer's Web Interface. This is the easiest way to access the digitizer as it requires no additional I/O drivers.

NOTE

Complete instructions for PC connection, configuration and communication are provided in "[Connecting the L4532A/34A to Your Computer](#)" on page 75. Refer to that section to make and configure your desired connection.

To get started using the digitizer:

- Install the Agilent IO Libraries Suite from the Automation-Ready CD-ROM that is shipped with your instrument.
- Connect and configure a LAN or USB connection.
 - For LAN connection, use a standard Category 5 LAN cable.
 - For USB connection, use a USB 2.0 A-plug to B-plug cable.
- Run the Connection Expert utility of the Agilent IO Libraries Suite to verify that the computer automatically recognizes the digitizer. This may take several seconds. If the instrument cannot be found, you can add the instrument using the IP address displayed on the front panel.
- You can now use Interactive IO within the Connection Expert to communicate with your digitizer, you can program it using various programming environments, or you can use the Web Interface (next section).

Using the Web Interface

The web interface is very useful for getting up to speed quickly using the L4532A/34A digitizers. Its main benefits:

- The easy to navigate interface and help screens provide a quick way to familiarize yourself with most digitizer configuration and acquisition options.
- You can make all key configuration settings and install measurements from one page (**Configure Digitizer**).
- You can initiate acquisition, view data on an oscilloscope-like graphical display, view derived measurements, and fetch data, all from one page (**Acquire Data**).
- You can easily control system functions, such as reading and debugging errors, resetting power-on defaults, executing a device clear, save configured instrument states, running a self-test and performing device calibration; all from one page (**Utilities**).

The **Command Monitor** window displays the commands which result from each function you select, so that you can learn the commands necessary to build and verify an automated control program for your host application. For convenience, you may even cut and paste commands from the Command Monitor into your programming environment.

This section provides the instructions for accessing the web interface and a quick look at a few of its pages; just enough to connect a signal source to your digitizer and digitize your first samples.

For a more complete look at the Web Interface, explore the built-in Help screens.

Accessing the Web Interface

To use the Web Interface:

- 1 Make and configure a LAN connection. For complete LAN configuration help, see “[Connecting over LAN](#) beginning on [page 75](#).”
- 2 Turn on the digitizer. Following the power-on sequence note the digitizer’s IP address displayed on the front panel at IDLE.
- 3 Open the Internet browser on your PC. In the browser ‘Address’ window, enter the digitizer’s IP address as displayed on its front panel (for example, type 192.168.0.101).

The Web Interface’s ‘Welcome Page’ appears as shown below.

The screenshot shows the web interface for an Agilent L4534A digitizer. At the top, it says 'Agilent Technologies' and '20 MSa/s Digitizer'. Below that, it says 'Welcome to your Web-Enabled L4534A'. A table provides the following information:

Instrument:	L4534A
Serial Number:	US114
Description:	Agilent L4534A Digitizer US114
DNS Hostname:	192.168.0.101
NetBIOS Name:	A-L4534A-US114
IP Address:	192.168.0.101
VISA TCP/IP Connect String:	TCPIP::192.168.0.101::inst0::INSTR

Below the table, there is a link to 'Turn On Front Panel Identification Indicator' and a section for 'Advanced information about this Web-Enabled L4534A'. A photograph of the digitizer is shown on the right side of the page.

NOTE

In order to access the Web Interface’s Remote Control Page, you must have a Java-enabled browser. Internet Explorer 6.0 or later is recommended.

The Java applet is signed. You may see a dialog from your browser requesting permission to run this applet, and may have to enable the applet to run.

You do not need to have the Agilent IO Libraries Suite software in order to access the Web Interface. However, if you do have the IO Libraries, you can start the interface from the Agilent Connection Expert program that is provided with the IO Libraries.

NOTE

In some network configurations, a proxy server may prevent access to the instrument (i.e. “page cannot be displayed”). In this situation, configure the proxy from the Internet browser such that the proxy is not used for (IP) addresses within the range of those that can be assigned to the L4532A/34A.

Navigating the Web Interface

The Web Interface has three main pages (Welcome, Remote Control, and Network Configuration). Click on one of the icons at the left of any screen to get to the desired web page:



Welcome Page

The Welcome page (default when accessing the Web Interface) provides basic information and identification of the Agilent L4532A/34A instrument.



Remote Control Page

This page allows you to control the instrument over the LAN. You can configure the instrument, collect and display data, and perform many other tasks without programming.



Network Configuration Page

This page allows you to configure the LAN settings for your instrument on the network.



Help for this Web Page

This page allows you to access extensive Web Page help. Click on this icon for help on the currently selected page.

The Web Interface is self-guiding. The help  button provides complete help (in a separate pop-up window) for whichever other page you are viewing (e.g. the top three pages listed above, or one of their tabbed pages).

The Network Configuration Page allows you to easily make changes to LAN settings, using the help  button as necessary. See [“Connecting the L4532A/34A to Your Computer”](#) on page 75 for more complete guidance, if you wish to use program commands to make these changes.

The Remote Control Page provides access to most digitizer configuration and control settings, so we will explore it for the remainder of this chapter.

Begin by clicking the  (Remote Control page) icon.

The Remote Control page is not password protected from the factory. If passwords have been enabled, the following screen appears:



Enter the password if necessary; the Remote Control page loads.

Navigating the Remote Control Page

The Remote Control page (below) contains the four main icons at left, a panel at center with three tabs, and a Command Monitor... button at right which allows you to monitor the commands sent when you configure or operate the digitizer.

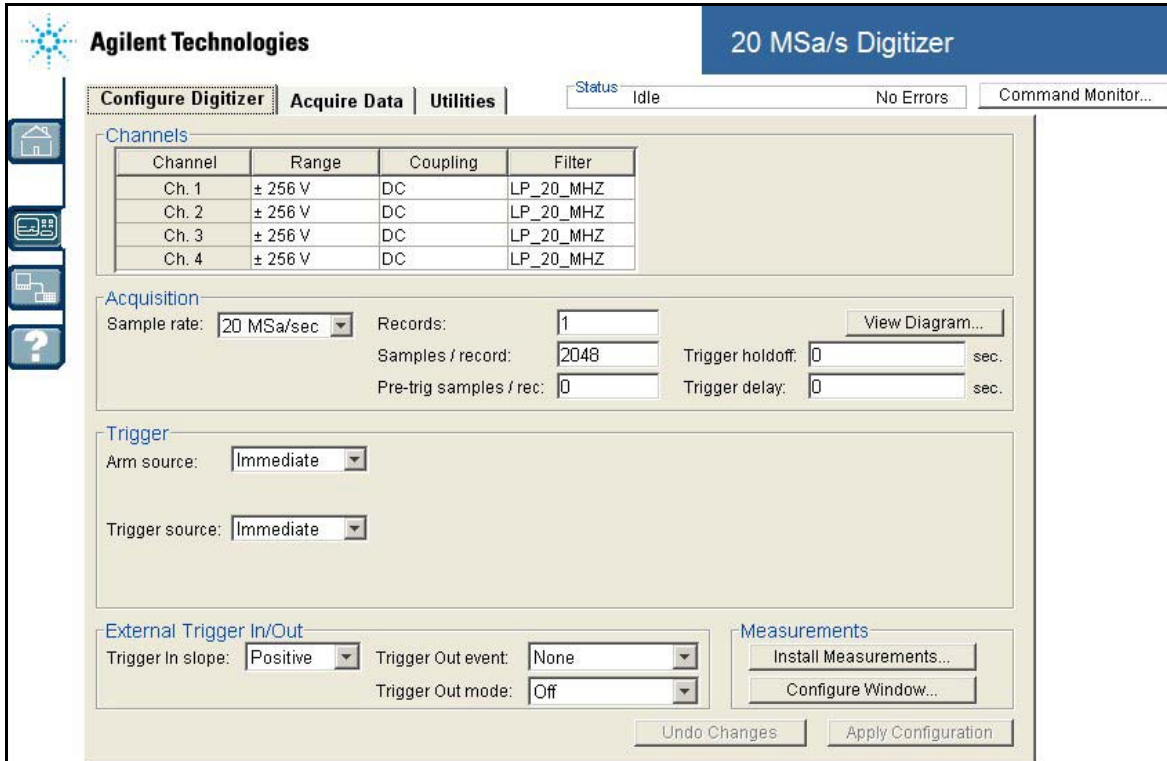

The three tabs are:



- **Configure Digitizer** - This tab appears first. It allows you to configure the digitizer and set up to acquire data.
- **Acquire Data** - This tab allows you to start an acquisition and display data graphically.
- **Utilities** - This tab allows you to access several utility functions, and even to send instrument commands from over the LAN.

Below the tabs are buttons to Apply Configuration or Undo Changes. Any changes you set do not take effect until *applied*.

The Command Monitor Button Clicking this button from the remote control page opens a second window (with two tabs), where you can view the actual commands sent to the instrument to put it in its current state (click the Current Configuration tab) or a list of commands issued (click the Command History tab). The Command Monitor window listing a typical configuration is illustrated below.

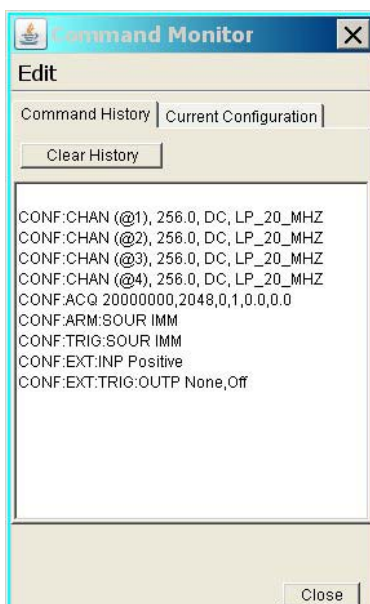

For convenience, you may cut and paste commands from the Command Monitor window into your programming environment.

The Configure Digitizer Tab Under this tab (illustration on previous page), you can configure most digitizer parameters. The table below lists these parameters, along with where they are described in more detail later in this manual:

In this Section	You can configure these parameters	A Complete Description of the Parameters, Allowable Values, Command Syntax and Examples can be found in:
Channels	input range	"Configuring Channel Attributes" on page 147
	coupling	
	low-pass filter settings	
Acquisition	sampling rate	"Configuring Acquisition (Sampling and Record Storage) Attributes" on page 148
	number or records	
	record size	
	pre-trigger size	
	trigger holdoff	
	trigger delay	
Trigger	arm source	"Configuring the Arm and Trigger Sources" on page 149
	triggers per arm	
	trigger source	
	trigger channel parameters (channel number, mode—edge or window—, edge or window voltage levels, hysteresis)	
External Trig Out	trigger-in slope,	"Configuring External Trigger In/Out Connector Parameters" on page 154
	trigger-out event	
	trigger impedance	

If you have the Command Monitor window open, you can view the resulting commands sent to the digitizer upon clicking the Apply Configuration button (the button becomes active only if you have made configuration changes).

The Acquire Data Tab Under this tab, the Web Interface provides a graphical representation of the sampled data in real time, as an aid in setup and troubleshooting. You can adjust the horizontal and vertical scales to selectively view data, and can set measurement markers.

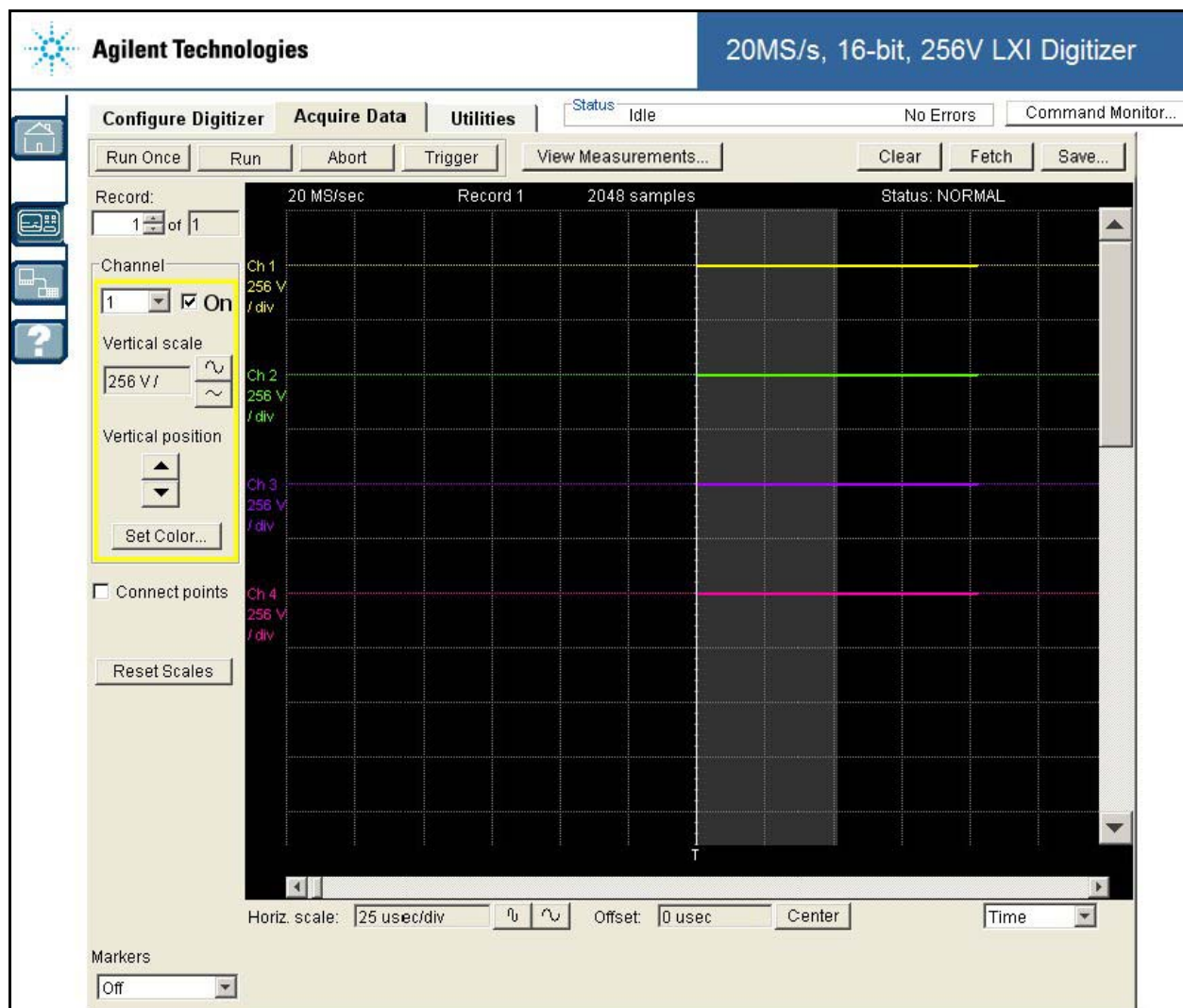

Some useful controls on this page are:

- The *Acquisition* buttons (**Run Once**, **Run**, **Abort** and **Trigger**) provide you the ability to acquire and view samples.
- The *Measurement Data* buttons (**Clear**, **Fetch**, **Save**) allow you to fetch select records and output to a file, or clear the displayed data.
- The **Measurements...** button opens a window where you can install measurements and read results.

The Utilities Tab Under this tab, you can:

- View and clear the digitizer's error queue
- Reset the digitizer
- Save or recall an instrument state
- Perform an instrument self-test
- Perform digitizer calibration or quick Auto Zero calibration

NOTE

Consult the *Agilent L4532A/34A Service Guide* before performing any calibration procedure. Calibration should only be performed by trained personnel.

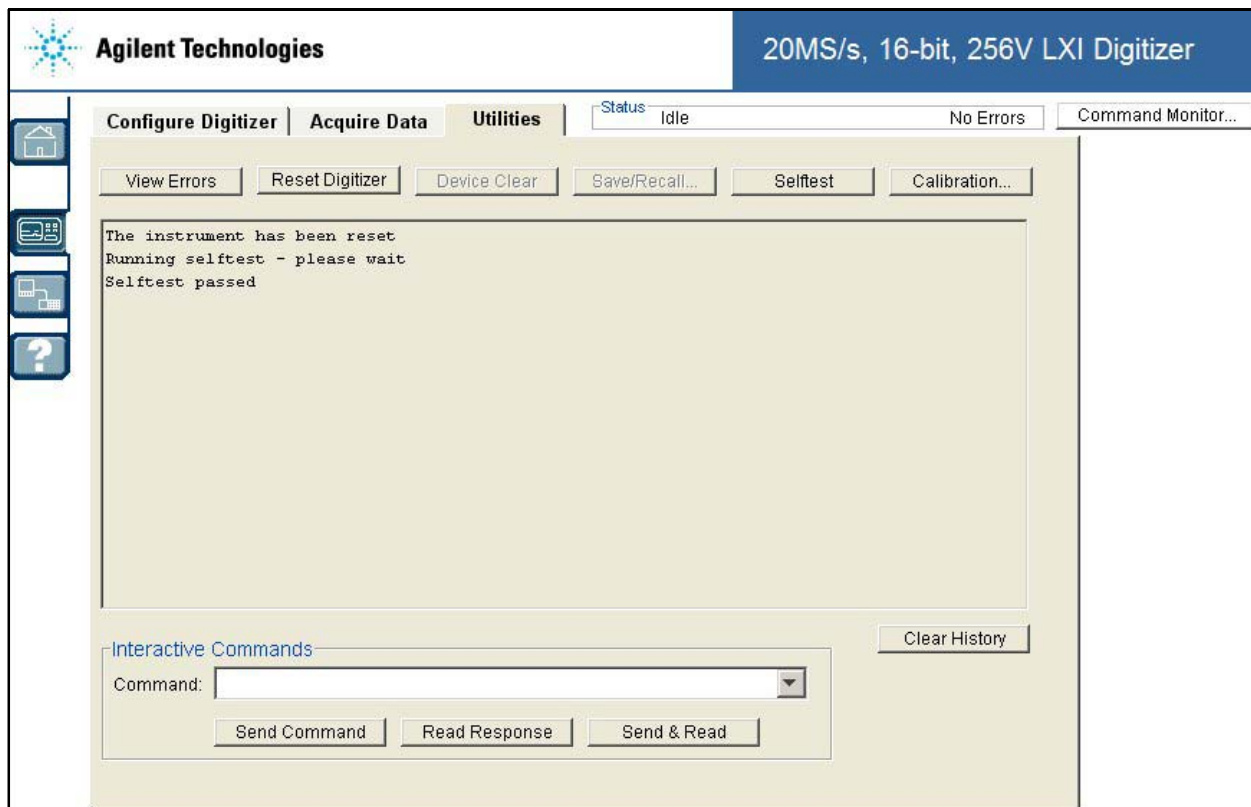

The Utilities tab also provides an interactive I/O window for sending commands and reading responses.

In the Subsequent Chapters...

Now that you have made a PC connection to the digitizer, it's time to explore more of the digitizer's features by sampling some inputs using the Web Interface.

[Chapter 3](#), “Practical Use Examples” provide three detailed applications of the digitizer in signal measurement. If you have a signal generator available, “[Example 1: Digitizing a Sine Wave](#)” on page 34 allows you to follow along step-by-step, take samples, change the configurable settings, install and make measurements. Two additional examples illustrate more advanced measurement and configuration features.

[Chapter 4](#), “Digitizer Programming and PC Connection” provides an introduction to the command language and detailed instructions for configuring a PC connection.

Once you are comfortable with your PC interface and the command language, [Chapter 5](#), “Understanding Key Concepts” provide an in-depth look at the digitizer operating states and configurable settings. You'll need to understand these concepts—the *what* and *why* of digitizer programming—to fully utilize the digitizer's advanced features, flexibility and speed.

Finally, with those fundamentals solidly understood, [Chapter 6](#), “Detailed Configuration and Operating Instructions” provides you the *how to*, enabling you to configure the digitizer to your exact needs and automate your device testing and measurement program.

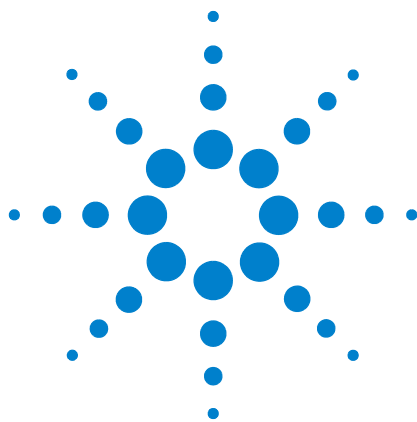

3 Practical Use Examples

This chapter provides three examples of signal acquisition and measurement using the L4534A digitizer (the concepts illustrated are also applicable to the two-channel L4532A). Two examples use the digitizer's built-in LAN-based Web Interface with Command Monitor, and they illustrate configuration settings and the resulting command syntax.

These examples are provided before the presentation of key concepts, detailed configuration, and operating instructions later in the manual, to help you consider your specific needs and develop your own use model.

Example 1: Digitizing a Sine Wave 34

- Learning Objectives 34
- Test Setup 34
- Digitizing Using Default Settings 34
- Controlling What Is Displayed 36
- Changing Channel Settings 38
- Changing Acquisition and Trigger Settings 39
- Saving Data to a File 41
- Using the On-Board Measurement Feature 43

Example 2: Digitizing a Solenoid Output Driver 47

- Learning Objectives 47
- Test Setup 47
- Making a First Measurement of Vpk for all Channels, Using Markers 52
- Making a More Accurate Measurement of Vpk 53
- Help with Host Application Programming 57
- Specifying Different Measurement Windows Using Discrete Measurements 58

Example 3: Digitizing Simultaneous Airbag Deployment Signals 62

- Learning Objectives 62
- Test Setup 62
- Physical Configuration of Multiple Digitizers 63
- Programming To Synchronize Multiple Digitizers 64
- Running the Measurement 66



Example 1: Digitizing a Sine Wave

In this example, we introduce how the L4534A digitizer samples a simple sine wave. If you wish to replicate the digitizer's behavior, you will need a signal source capable of generating a 10 kHz, 20 Vpp sine wave. You can also use a device with other capabilities and adjust settings accordingly.

Learning Objectives

Using the Web Interface, you will learn how to:

- View default configuration settings.
- Capture sample data and view an oscilloscope-like graphical representation of that data.
- Adjust the graphical display.
- View and change acquisition and trigger settings.
- View an acquisition diagram showing the relationships between the acquisition and trigger settings.
- Save the data to a file.
- Install and run simple parametric measurements based on the data.

Test Setup

The test signal is a 10kHz, 20Vpp sine wave, applied in this case from an Agilent 33220A Function Generator, to the digitizer's channel 1 input.

To follow this example live, your digitizer must be turned on, and an equivalent signal generator with a comparable signal must be connected. You must also have made a connection via the Web Interface (see [“Using the Web Interface”](#) on page 23).

Digitizing Using Default Settings

From the Welcome page in the Web Interface, click on the **Remote Control Page**  icon. The Remote Control Page loads, with the Configure Digitizer tab active.

Click the Command Monitor button; the Command Monitor opens in a separate window. This allows you to see the commands sent to the digitizer.

Inside the Command Monitor window, click the Current Configuration button; the program commands which set the current digitizer configuration are displayed. These commands reflect the default Channel, Acquisition, Trigger and External Trigger In/Out settings.

The Control Panel and Command Monitor windows, with default settings, are shown below.

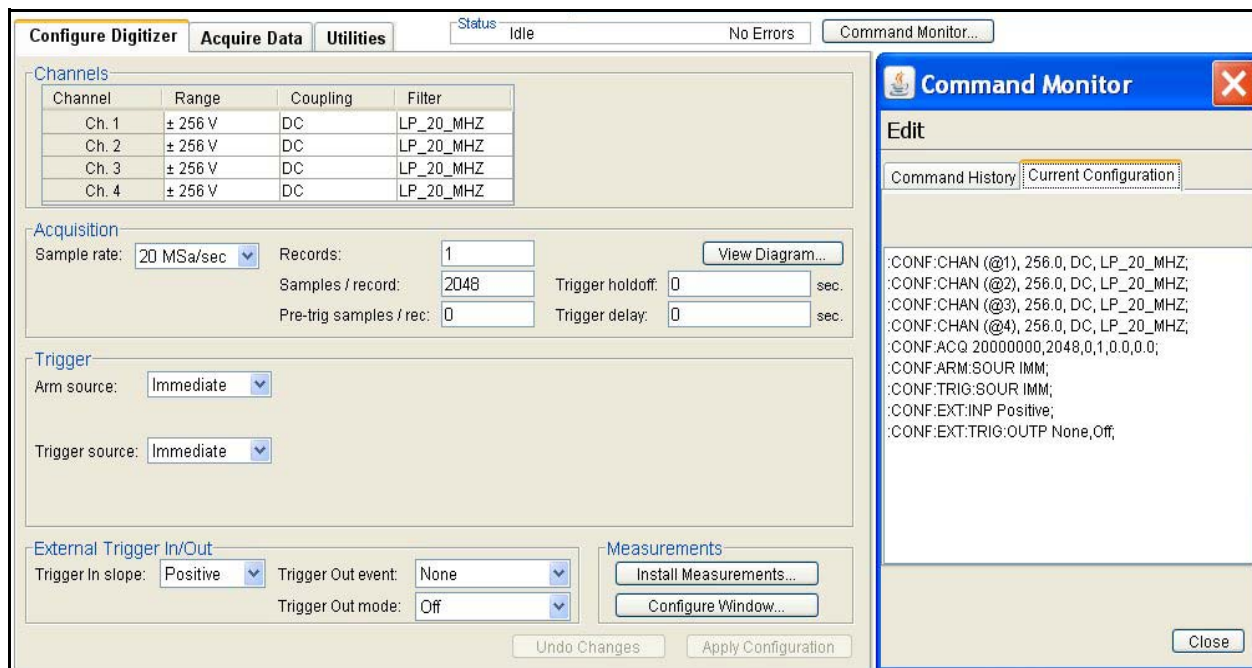

Click the **Acquire Data** tab, then click the Run button. We see the digitizer continually triggering (“Acquiring”), and we see activity on channel 1. Under the Command History tab, we see the repeated acquisition commands as the digitizer is set for immediate triggering by default.

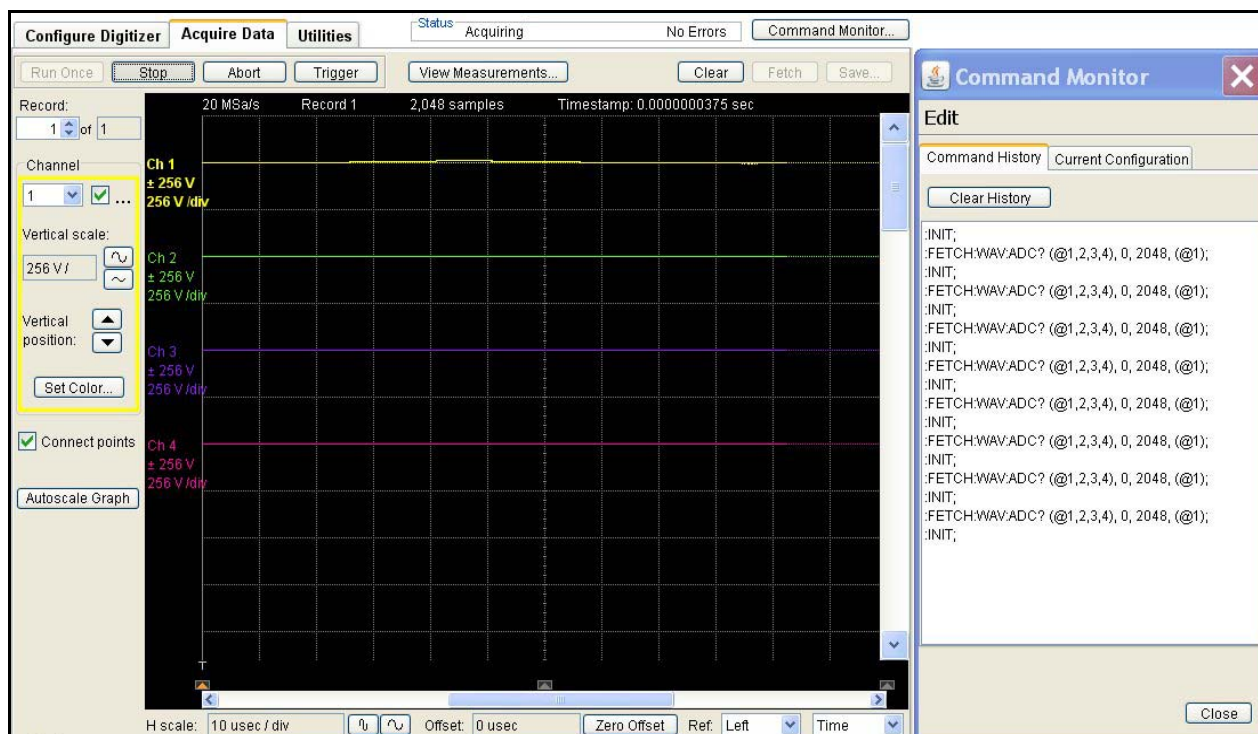

Controlling What Is Displayed

Because we were viewing a 10Vpk signal on a ± 256 V default range, the waveform was barely distinguishable. Click the Autoscale Graph button; we now see the sine wave. Autoscale Graph independently changes the displayed scale for each input, so it set Channel 1 to 16 V/division and the other three channels to smaller scales; hence background noise (floating inputs with no signals attached) is visible. Note that this only changes the displayed scale; the input range is still ± 256 V.

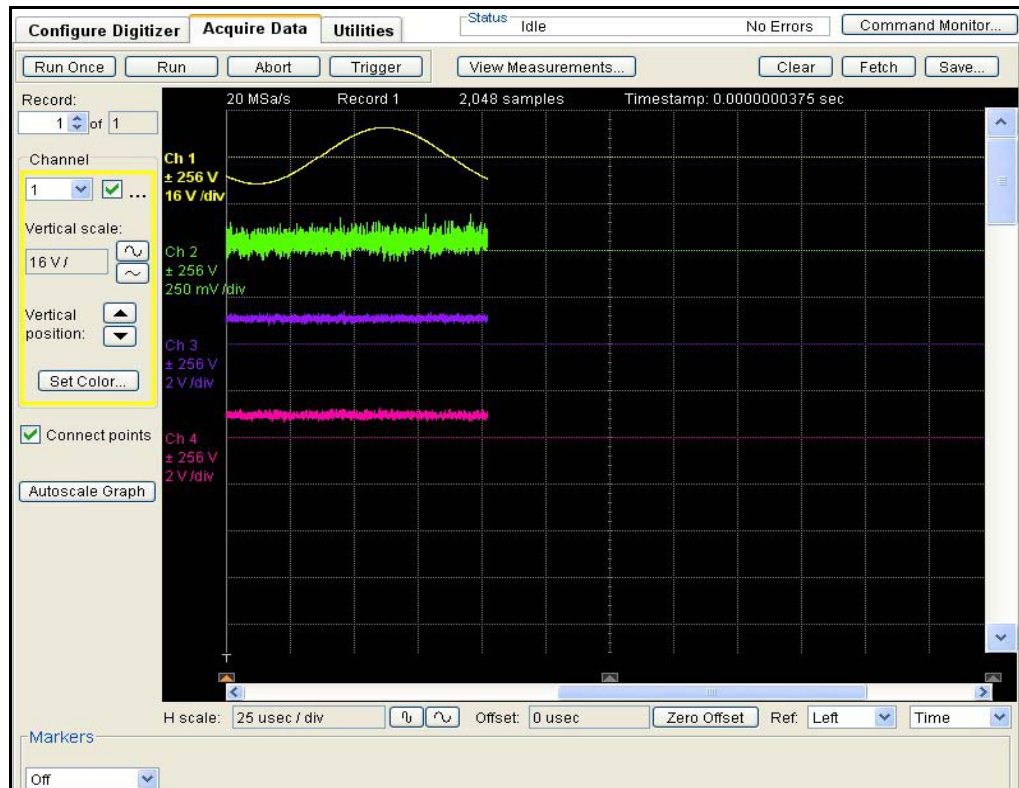

All four channels are displayed, even though we are interested in only one. To focus on channel 1, we will turn off the other channels:

- In the Channel control box, click the drop-down list, select Channel 2, and un-check the On box. You will see the Vertical scale, Vertical position and Set Color buttons disappear, as you will not be displaying Channel 2 information.
- Repeat for Channels 3 and 4 if you are using an L4534A.
- Select Channel 1 again, so that you can change this channel's scale and position.

Using the Vertical scale and Vertical position buttons, adjust the sine wave to fit the display area height (2V/division should do nicely). You can do this while acquiring. Using the H scale button, adjust the sine wave to fit the display area width (10 μ s/division works well).

By not displaying channels we are not interested in, and by using the oscilloscope-like display controls, we can see just what we need to. The display now shows a good representation of the waveform. The display clearly shows us the expected 10V signal peak and 100 μ s period:

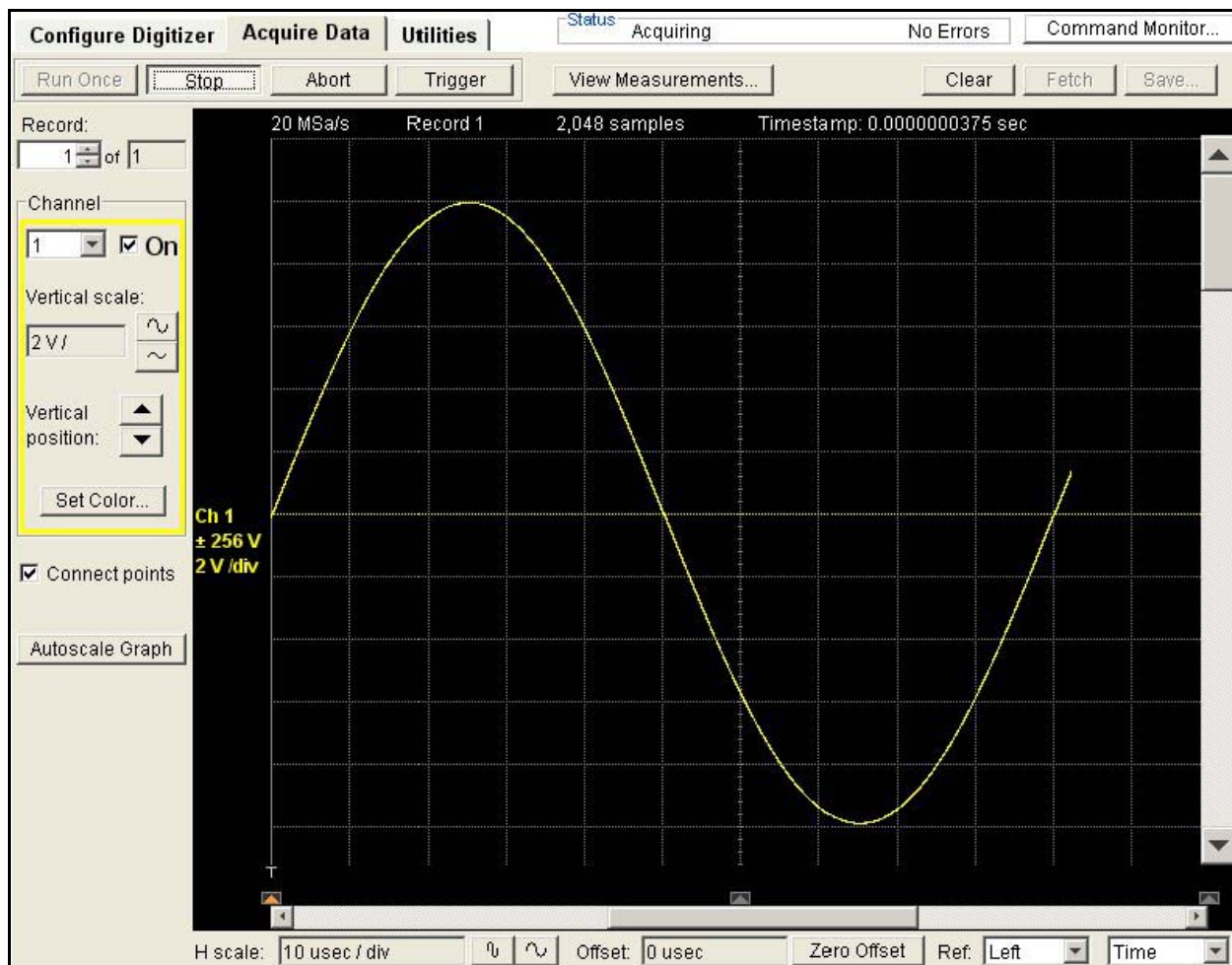

Note the trigger is marked by a white line with a T at the bottom left corner of the graph.

Since the default settings use immediate triggering, the sine wave you view may be slightly different in phase, depending on when the trigger occurred on your digitizer. Here we show the trigger at 0 V with the signal rising.

Changing Channel Settings

Although the L4532A/4A captures the sine wave at the default ± 256 V default range, we can improve resolution by changing to a smaller input range.

In the Channels section of the Configure Digitizer screen, change Ch.1 Range to ± 16 V. Click Apply Configuration; the Command Monitor shows the commands sent to implement the changes you just made.

Return to **Acquire Data** and click Run. The captured waveform is smoother than at the default range setting.

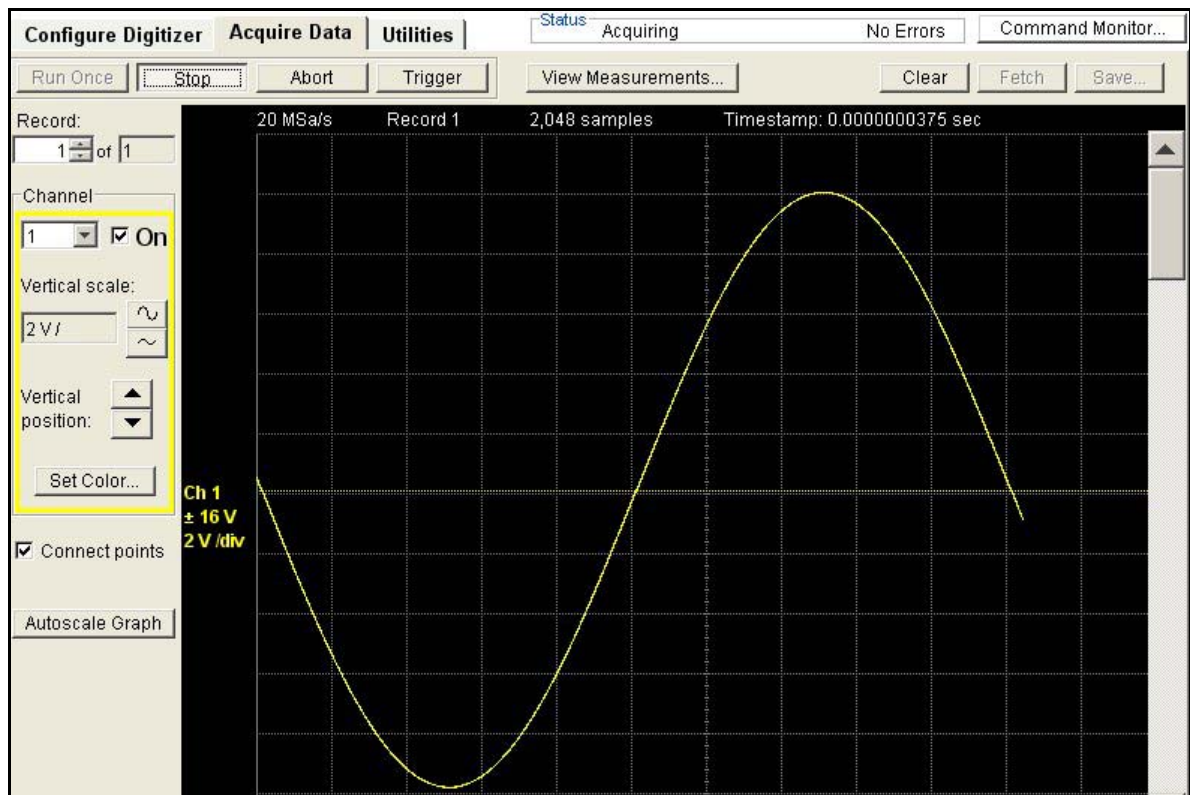

Let's do some basic digitizer math:

Signal Frequency = 10 kHz
 Sampling Rate = 20 MSa/s (default)
 Samples Per Cycle = 2000

Therefore, at 2048 samples per trigger, we would expect to see the digitizer capture slightly more than one cycle of the waveform per trigger, and we do.

Simply by chance, as we chose a 10 kHz input signal, we acquired more than one cycle, and the immediate trigger took place at a random point in the cycle. In practice, you will want to specify configuration settings that capture a planned number of pre and post-trigger samples.

Changing Acquisition and Trigger Settings

We will now refine our digitizer's configuration settings to capture exactly one full cycle of 2000 samples, triggering on the rising edge at a 2 V level, with 100 pre-trigger samples and 1900 post-trigger samples.

Under the **Configure Digitizer** tab:

- Change Samples / record to 2000
- Change Pre-trig samples / rec to 100
- Change Trigger source: to Channel (this opens a Channel dialog box)
- For Ch. 1:
 - Change Mode to Edge, Positive
 - Change Level (V) to 2.0

Click the Apply Configuration button; the Command Monitor window shows the commands sent to implement the changes you just made.

Hint: If you click the View Diagram button; an Acquisition Diagram window pops up, showing the relationships between the trigger event, record size, pre and post-trigger samples. The Control Panel, Command Monitor and Acquisition Diagram windows should look like this:

The screenshot displays the 'Configure Digitizer' software interface with three windows open: 'Configure Digitizer', 'Command Monitor', and 'Acquisition Diagram'.

Configure Digitizer - Channels Table:

Channel	Range	Coupling	Filter
Ch. 1	± 16 V	DC	LP_20_MHZ
Ch. 2	± 256 V	DC	LP_20_MHZ
Ch. 3	± 256 V	DC	LP_20_MHZ
Ch. 4	± 256 V	DC	LP_20_MHZ

Configure Digitizer - Acquisition Settings:

- Sample rate: 20 MSa/sec
- Records: 1
- Samples / record: 2000
- Pre-trig samples / rec: 100
- Trigger holdoff: 0 sec.
- Trigger delay: 0 sec.

Configure Digitizer - Trigger Settings:

- Arm source: Immediate
- Trigger source: Channel

Channel	Mode	Level (V)	High Level(V)	Hysteresis (%)
Ch. 1	Edge, Positive	2.0	-	2.0
Ch. 2	Off	-	-	-
Ch. 3	Off	-	-	-
Ch. 4	Off	-	-	-

Command Monitor - Current Configuration:

```

:CONF:CHAN (@1), 16.0, DC, LP_20_MHZ;
:CONF:CHAN (@2), 256.0, DC, LP_20_MHZ;
:CONF:CHAN (@3), 256.0, DC, LP_20_MHZ;
:CONF:CHAN (@4), 256.0, DC, LP_20_MHZ;
:CONF:ACQ 20000000,2000,100,1,0,0,0,0;
:CONF:ARM:SOUR IMM;
:CONF:TRIG:SOUR CHAN;
:CONF:TRIG:SOUR:CHAN:EDGE (@1),2.0,POS,2
:CONF:TRIG:SOUR:CHAN:OFF (@2);
:CONF:TRIG:SOUR:CHAN:OFF (@3);
:CONF:TRIG:SOUR:CHAN:OFF (@4);
:CONF:EXT:INP Positive;
:CONF:EXT:TRIG:OUTP None,Off;
    
```

Acquisition Diagram:

This diagram is based on the acquisition parameters showing, drawn approximately to scale

Record: 2000 Samples (0.1 msec)

Trigger

Now go back to **Acquire Data** and click Run.

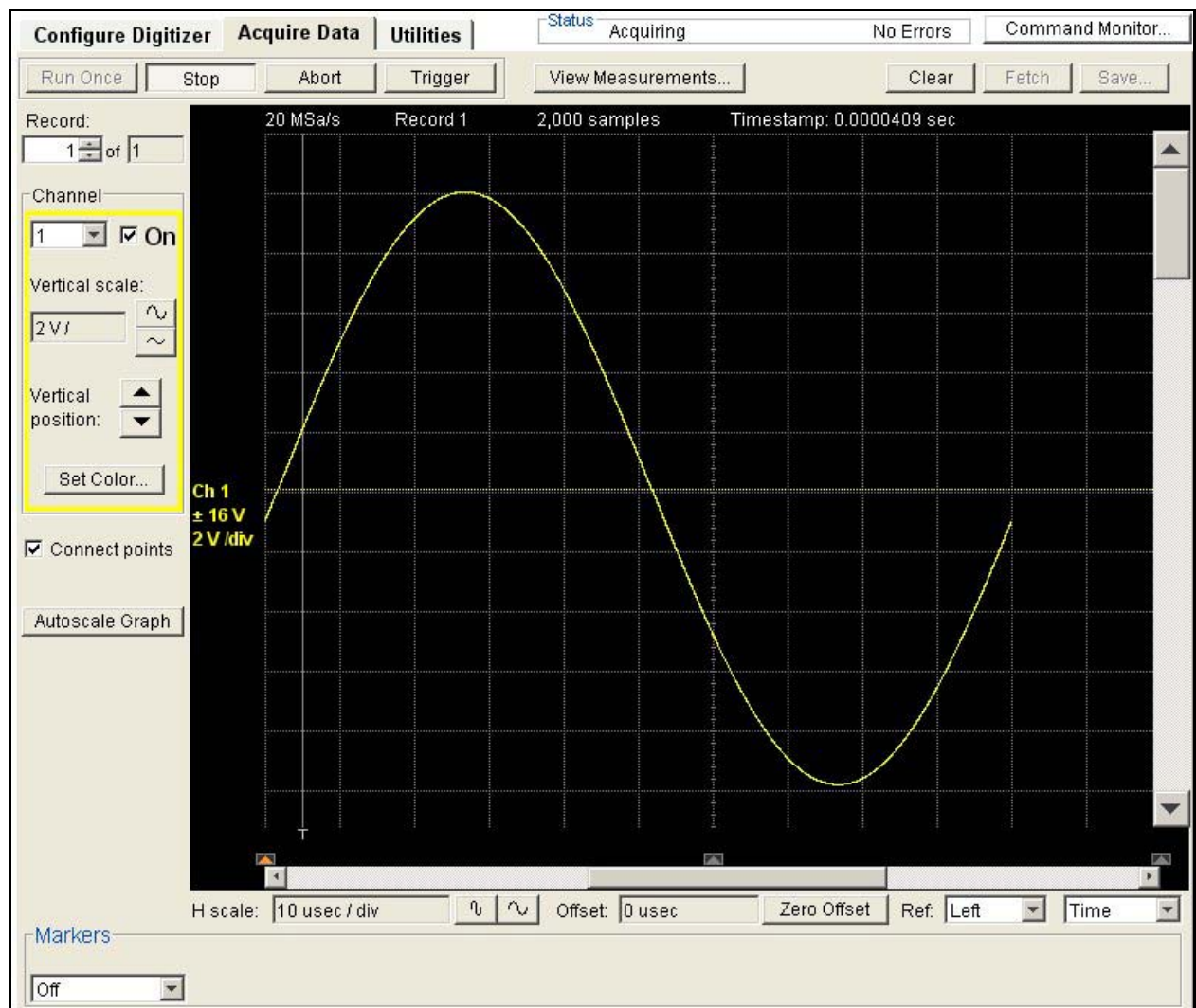

You now see one complete cycle (2000 samples) of the waveform, beginning 100 samples before the trigger event. The trigger is marked by a white line with a T at the bottom, intersecting the waveform at 2V as expected.

Saving Data to a File

Click the Stop button (this stops data acquisition), then the Save... button. The Save Data to File dialog box opens in a separate window.

When saving data you can specify individual channels and records, a starting sample number and sample count, and the output format (actual voltages or analog-to-digital conversion (ADC) codes). With the Web Interface, you can also specify a file name and if you want a comma-delimited list (a .csv format which can be imported into a spreadsheet) or a text file.

Below, we have specified saving voltage data from channel 1 to a text file.

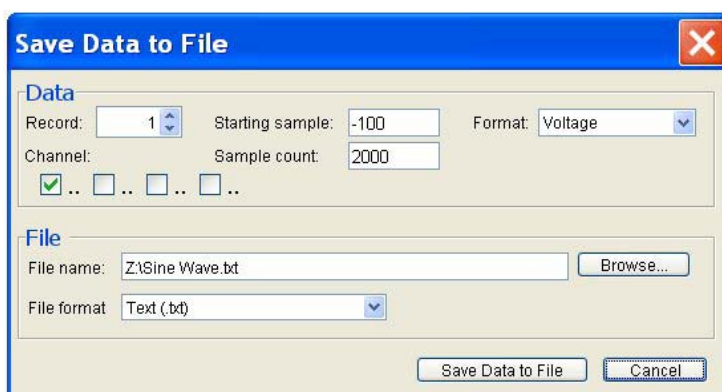

Here is an excerpt for the sine wave example, from the top of the saved text file (output format is typical).

```
Instrument:, Agilent Technologies, L4534A, US114, 0.41-21-1d-1d
Date: Wed Mar 25 16:57:49 MDT 2009
Sample rate: 20000000
Starting sample: -100
Record: 1
Record timestamp: 3.4699999999999996E-5

Channel: 1
Range: 16.0V
Coupling: DC
Filter: LP_20_MHZ
-1.094272E00
-1.073763E00
-1.037629E00
-1.008332E00
-9.809870E-01
-9.468063E-01
-9.126255E-01
-8.833277E-01
-8.515885E-01
```

Below, we have specified saving the same data from channel 1 to a .csv file, with ADC output.

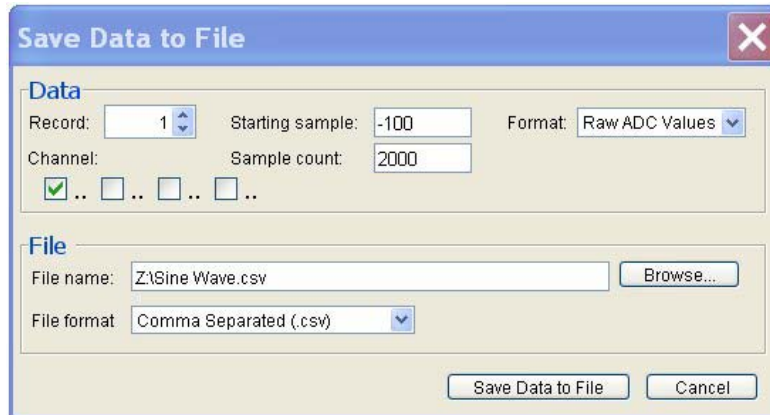

From the earlier sine wave example, here is an excerpt from the .csv output, corresponding to the voltage-value text file on [page 41](#).

	A	B	C	D	E
1	Instrument:	Agilent Technologies	L4534A	US114	0.41-21-1d-1d
2	Date:	Wed Mar 25 17:03:05 MDT 2009			
3	Sample rate:	20000000			
4	Starting sample:	-100			
5	Record:	1			
6	Record timestamp:	3.4699999999999996E-5			
7					
8	Channel:	1			
9	Range:	16.0V			
10	Coupling:	DC			
11	Filter:	LP_20_MHZ			
12		-2241			
13		-2199			
14		-2125			
15		-2065			
16		-2009			
17		-1939			
18		-1869			
19		-1809			
20		-1744			

The .csv file produced from the Web Interface's Save command allows you to analyze and perform calculations on the data in spreadsheets and other data analysis software.

Using the On-Board Measurement Feature

A sine wave, as it presents well-known parametric measures, is a good opportunity to familiarize yourself with the digitizer's on-board measurement capabilities. The available measurements are listed in “[Sampling and Measuring Capabilities](#)” on page 3; detailed instructions for their use are provided in “[Making On-Board Measurements](#)” on page 169.

The digitizer can make two types of measurements: discrete and installed. *Installed* measurements are those you program before data acquisition; they are calculated immediately after acquisition completes, but you must issue a separate query to retrieve the results. From the Web Interface, the retrieval is automatic. You can also re-run the installed measurements after acquisition using a separate command, after changing the window or threshold settings on which they are based.

Once programmed data acquisition is complete, you can query any number of *discrete* measurements; these are individual queries you program only from the host application (not available from the Web Interface) to return measurements calculated from acquired data.

For both types of measurements, you must specify a *window*; a range of samples used to calculate the measurement(s). This feature allows you to focus your measurements on an area of your waveform which contains information of interest (for example: signal peaks, pulse width, settling time). The Web Interface's display allows you to select this window visually.

We will introduce installed measurements in this example, and we will use them more extensively in the next example.

To begin, from the **Acquire Data** tab click View Measurements to open the Installed Measurements window.

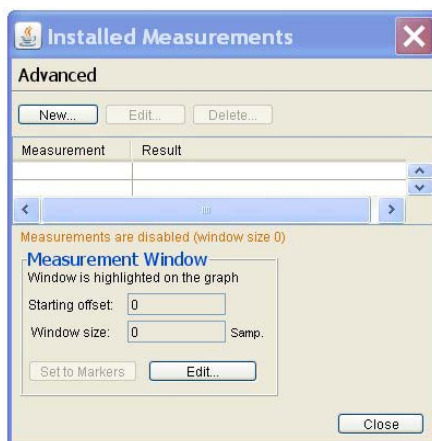

Notice that the default Measurement Window has both Starting Offset and Window Size set to 0; this will result in no measurements, so we will change these.

Click the Edit... button in the **Measurement Window** to open the Measurement Window dialog box. Click the All Samples in Record button; note that this sets Starting offset to -100 (the number of pre-trigger samples) and Window size to 2000 (the number of total samples). Click OK; you will see the numbers change under Measurement Window:

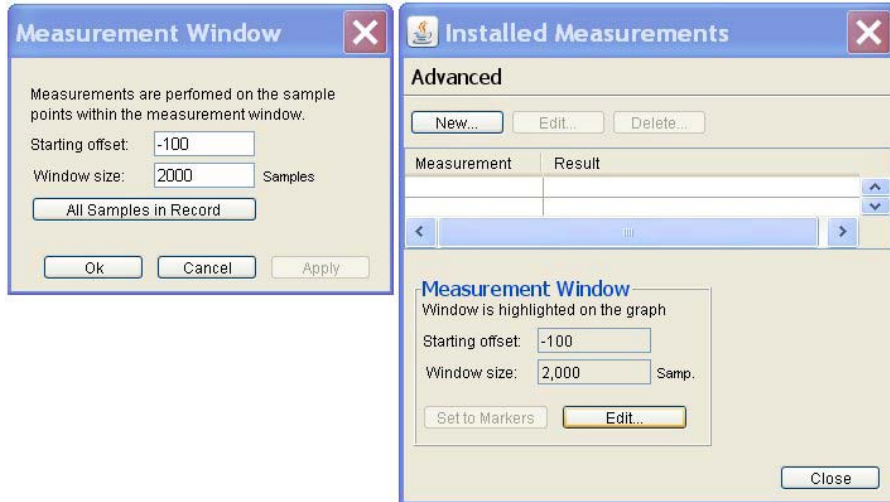

Click the New... button under Measurement Window; the Install New Measurement window pops up.

- From the Measurement drop-down list, select Vmax. Click OK.

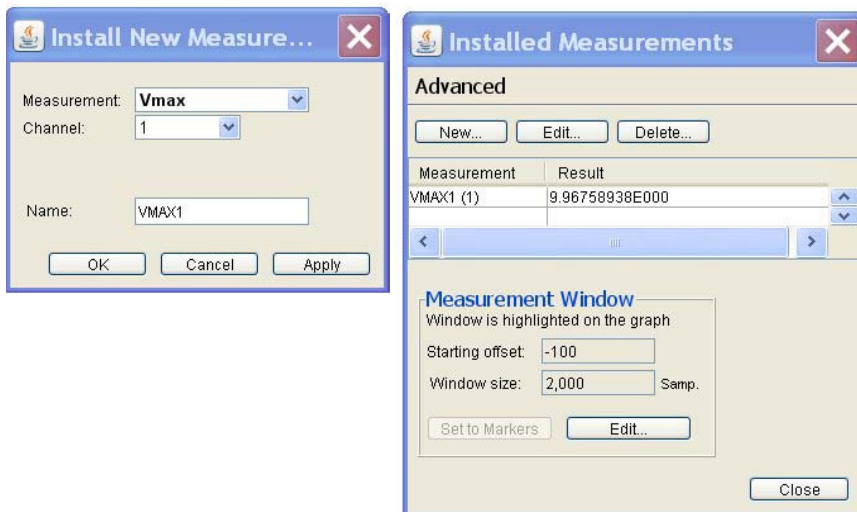

The digitizer calculates Vmax from one cycle of the waveform, and the value is approximately the expected 10 volts. From the Command Monitor, you will see the three commands necessary to install, run and fetch results from the installed measurement.

```
:MEAS:INST:DEF VMAX1,"MEAS:VMAX? (@1)";
:MEAS:INST:RUN;
:MEAS:INST:RES:REC:VERB? ALL,1;
```



The command MEAS:INST:RUN is only needed when the measurements are installed after acquisition. If they were installed first, they would be run automatically after acquisition completes. You would still need to send a command to query the measurement results.

We will now install a few more measurements:

- Click the New... button under Measurement Window. From the Measurement drop-down list, select Vamplitude. Click Apply.
- Click New... . Select Rise Time. Note that you could also specify Channel, Edge and name the measurement; we will use the defaults. Click Apply.
- Click New... . Select Frequency. From the Edge drop-down list, select Rising. Click Apply.
- Click New... . Select Pos Pulse Width. Click OK.

From the Command Monitor, you can see that these measurements are all installed. When acquisition is run from the Web Interface, the measurement results are automatically queried at the end of acquisition. When you run acquisition using commands from another host application, you will have to explicitly send the commands to acquire data and query the measurement results.

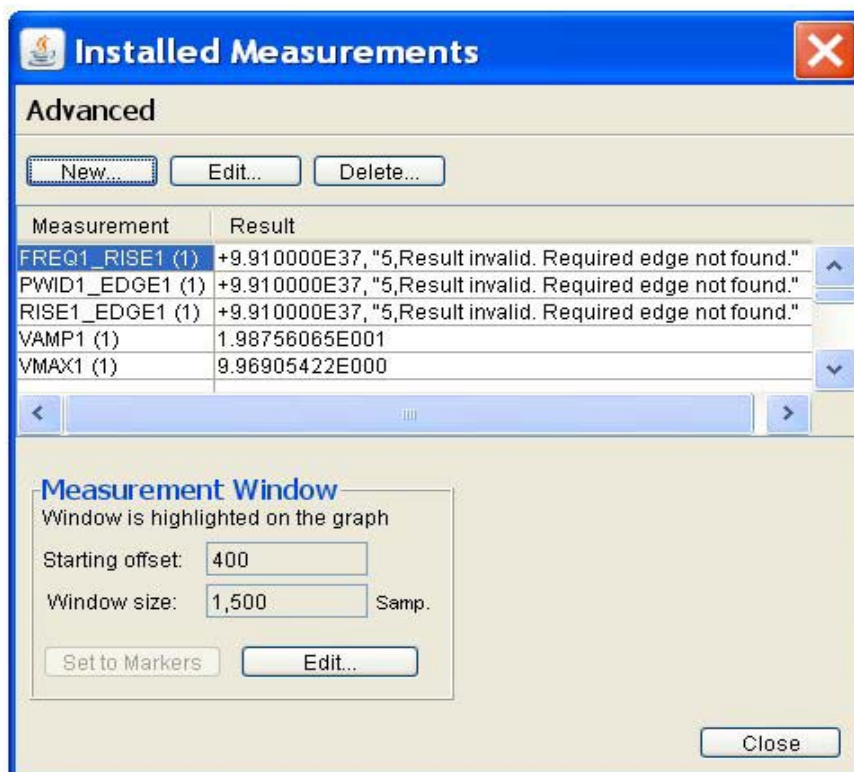
Looking at the Installed Measurements window, we find that the three time-based measurements returned an invalid result, with an error "...Required edge not found."



This is because we sampled only one cycle of the waveform in each record, and we began sampling partway up the rising edge, so the measurement algorithm could not see an entire rising edge. We will change that, by sampling more than one complete cycle and changing our measurement window.

- Under the **Configure Digitizer** tab, change Samples / record: to 5000 and Apply. We need to capture a bit more than two cycles, to ensure that we get at least one whole cycle beginning with a rising edge, since we triggered at +2V rising. We could capture fewer total samples by triggering at a different point, but changing just the sample size per record is easy.
- Return to **Acquire Data** and Click Run to begin acquiring data.
- Click View Measurements to reopen the Installed Measurements window.
- Under Measurement Window, click Edit... . In the dialog box, click All Samples in Record and OK.

Now, with a window size of 5000 samples, we get the expected measurement results. Notice that the display indicates the measurement window with a grey background:

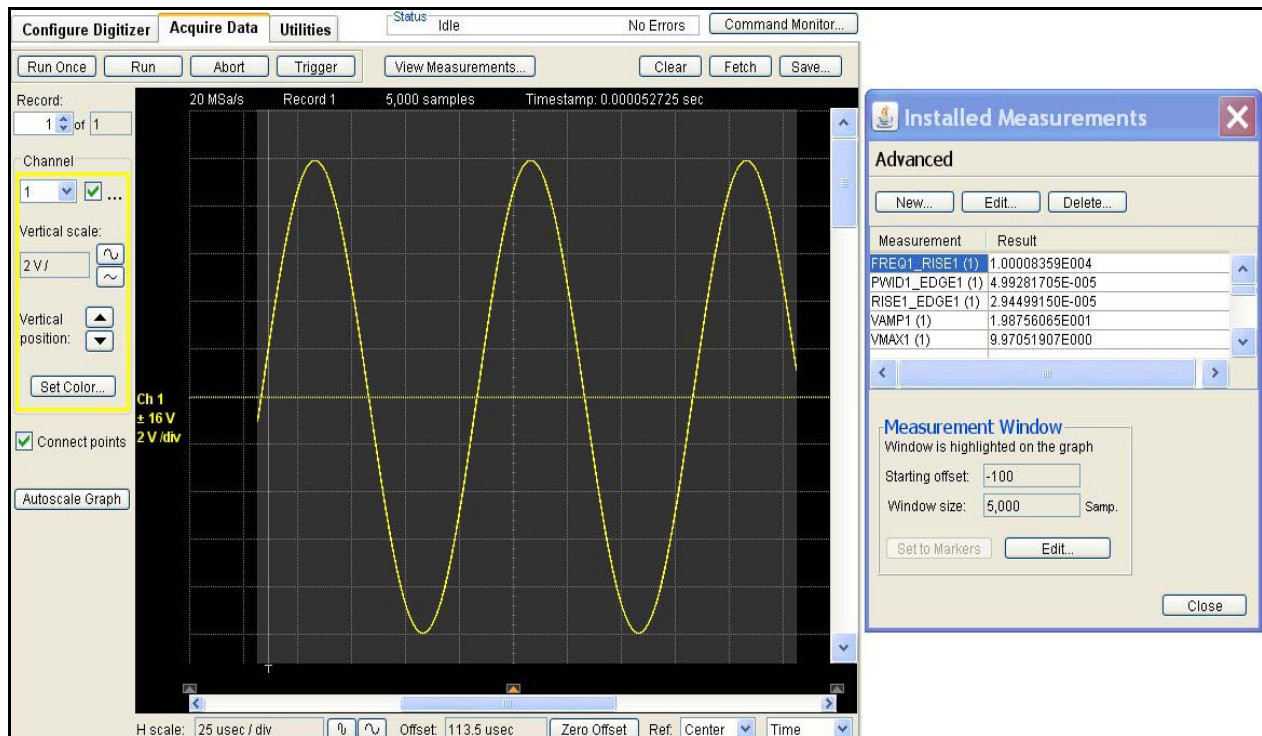

In the next example, we'll examine some more sophisticated ways to control and use Window size.

Example 2: Digitizing a Solenoid Output Driver

One good application of the L4534A digitizer is measuring several parameters of a high-speed voltage transient. Many electrical devices produce such a transient; the example below exhibits typical characteristics of high-speed, multiple channel measurement.

Learning Objectives

Using the Web Interface, you will learn:

- How to capture a fast, high-voltage transient, by triggering on its rising edge.
- How to configure edge triggering on multiple channels and take advantage of the digitizer's fast re-arm time to capture separate records from rapidly occurring events.
- How the digitizer can accurately capture both high-voltage and low voltage components of a signal using one range.
- How to capture and use pre-trigger and post-trigger data in a record.
- How to use the Web Interface to help program your host application's software.
- How to set the measurement window size and position for individual measurements from the same data capture.

Test Setup

Automotive electronic control units (ECUs) drive many types of electromechanical devices with solenoid loads, including fuel injectors. The illustration below shows a typical arrangement of ECU and four fuel injectors:

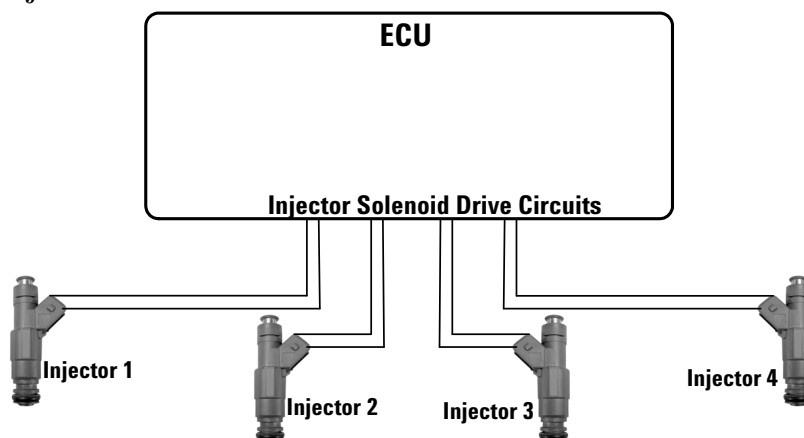

These loads are inductive. The electronic fuel injection (EFI) control circuitry generates each injection pulse, sustains high current to the injector solenoid to control injection time and shuts off. When the injector shuts off, the solenoid's magnetic field collapses, inducing a large flyback voltage transient.

As the ECU pulses the injectors sequentially, each set of four pulses—if viewed on an oscilloscope—might look like this:

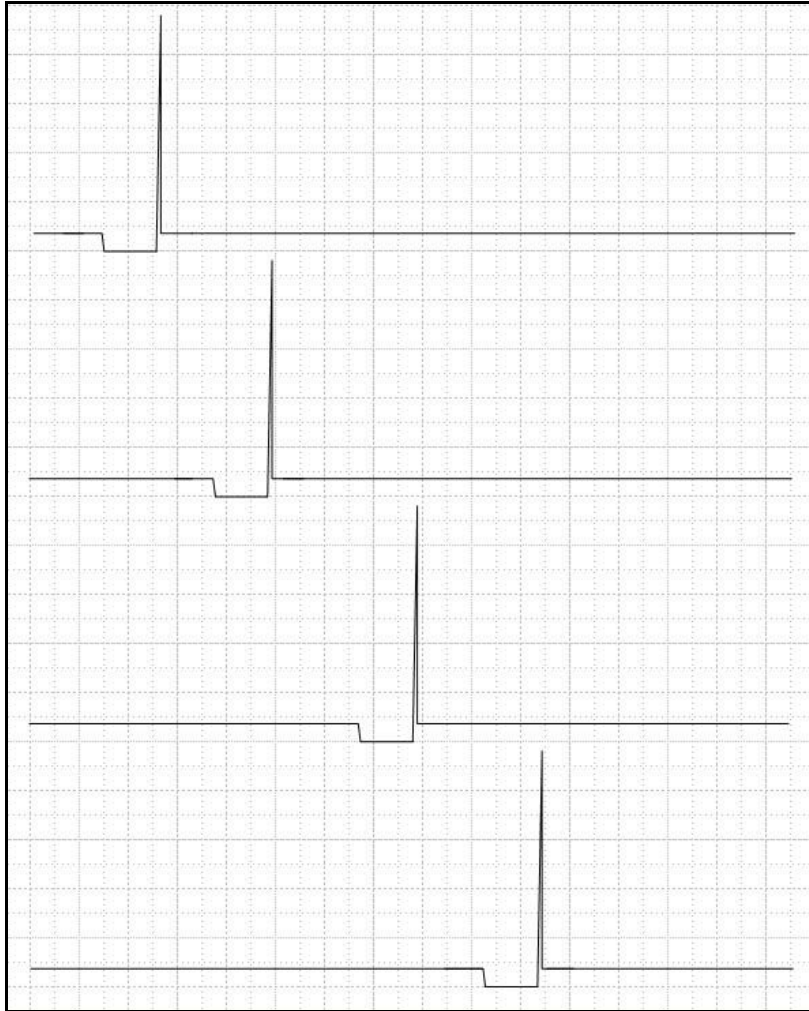

Our goal is to capture the ECU solenoid driver pulses for a set of four injectors. We will need to capture each complete pulse event, from before the pulse begins to after any settling noise following the flyback. At 2000 rpm, the engine fires each cylinder 1000 times per minute; it therefore sends about 67 injection pulses per second, 15 ms apart.

Injectors vary depending on load; for this example we will expect a pulse width of approximately 4 ms. Capturing 10 ms of information per event should be adequate, and takes advantage of the digitizer's very fast rearm time—about 500 ns.

The diagram below illustrates the performance parameters of the ECU's output driver, which include:

- t_{on} – the fall time of the (negative) injection pulse
- V_{dson} – the voltage level of the injection pulse
- t_{off} – the rise time of the flyback voltage
- t_{pw} – the flyback voltage spike's pulse width
- V_{pk} – the statistical maximum value of the peak flyback voltage

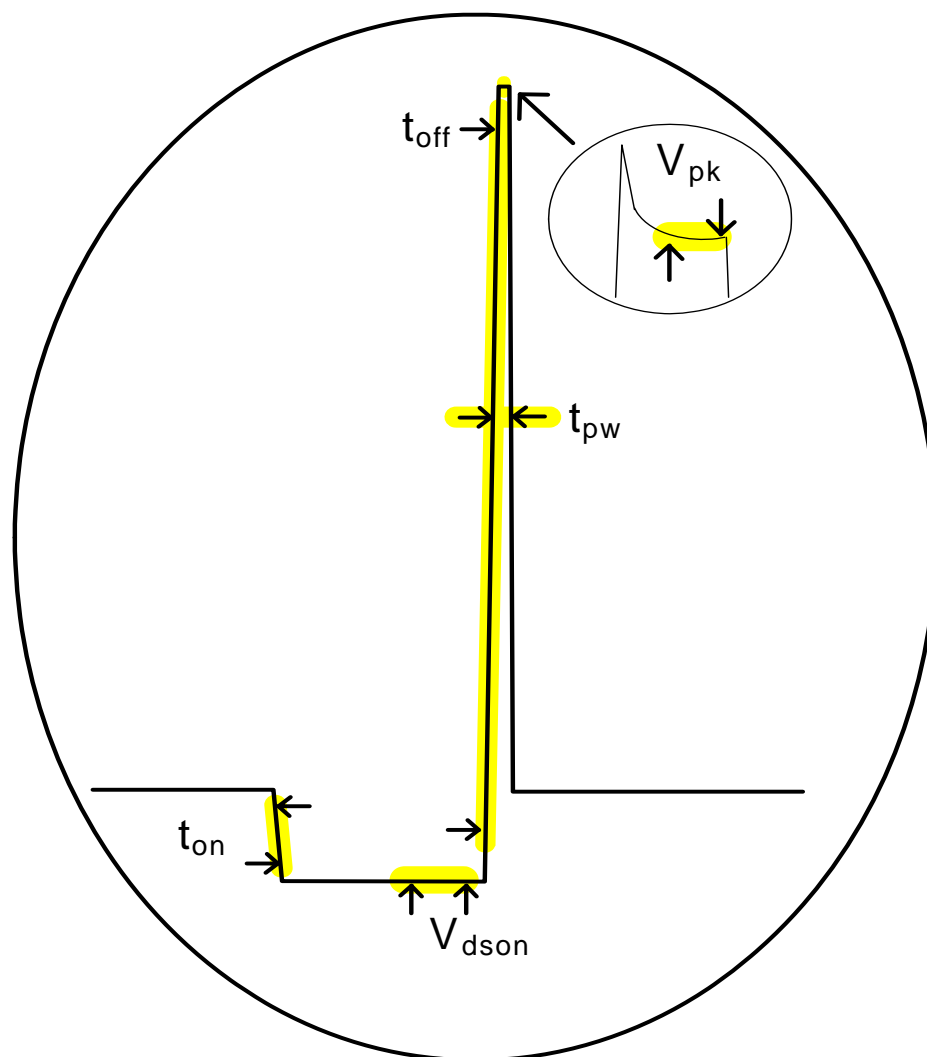

As we explore this example, the inputs displayed were captured from simulated signals representing the solenoid driver outputs. You probably will not be able to duplicate them as with the sine wave example, but you can follow along to learn how the digitizer is set and the measurements are configured.

Capturing All Four Solenoid Drives

For the first look at the four solenoid drives, we will need to route the four solenoid flyback signals to channels 1 through 4, then start by selecting the following digitizer settings:

- Use the default ± 256 V range for all channels.
- Set the sampling rate of 10MSa/s.
- Capture one record of 32,000,000 samples per record (3.2 seconds of data).
- Use immediate arming and triggering (default).

From the pulse timing illustrated on [page 48](#), the waveforms generated from the solenoid drivers will be captured and stored in a single record in sample memory. The first four pulses (from the 3.2 seconds of data) would be represented in memory as shown below:

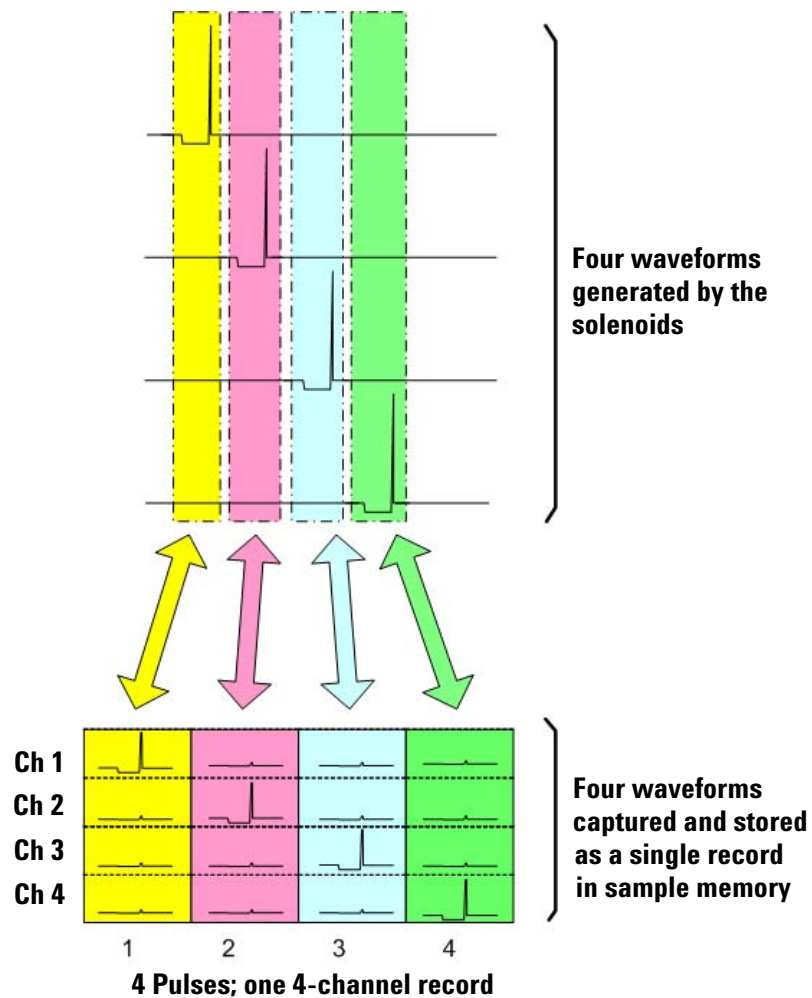

We begin sampling by clicking Run on the **Acquire Data** tab, then inspect the displayed waveforms.

To first see the four samples taken on each channel, we set:

- H scale: = 50 msec/div
- Offset: = 180 msec (click and drag the Center Reference horizontal slider to change)

The data captured below illustrates four cycles of all four injector pulses.

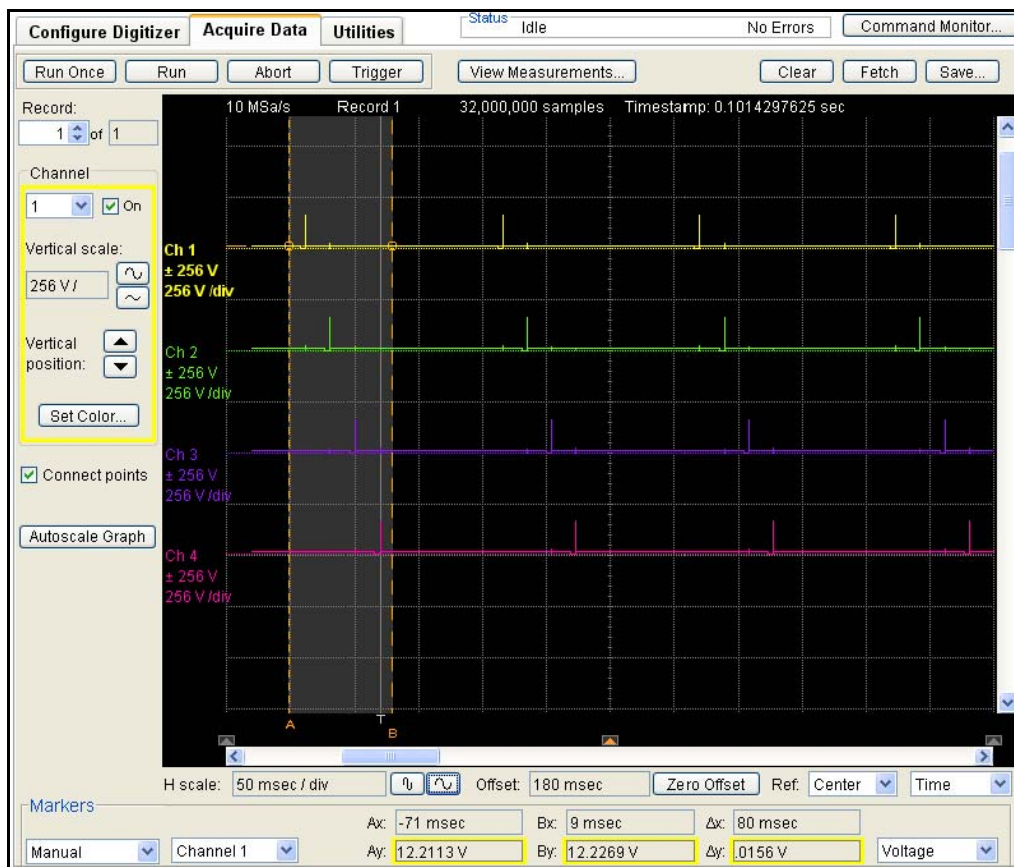

Making a First Measurement of Vpk for all Channels, Using Markers

From the data we acquired on the previous page, we will install a set of measurements which will give us a quick look at the statistical maximum values for each solenoid drive.

- At the bottom left of the **Acquire Data** tab, change Markers to Manual using the drop-down list.
- Set a measurement window Δx with the horizontal markers, as follows:
 - Click and drag the left marker **A** until Ax: is set left of the pulse on channel 1 (-71 ms).
 - Click and drag the right marker **B** until Bx: is set right of the pulse on channel 4 (+9 ms).
- Install a VTOP measurement for each of the four channels, making sure that Set to Markers is selected in the Measurement Window dialog box.

Now we click the Clear button and click Run again. The display is shown below, and the resulting VTOP measurements are all in the range of 160-165 V:

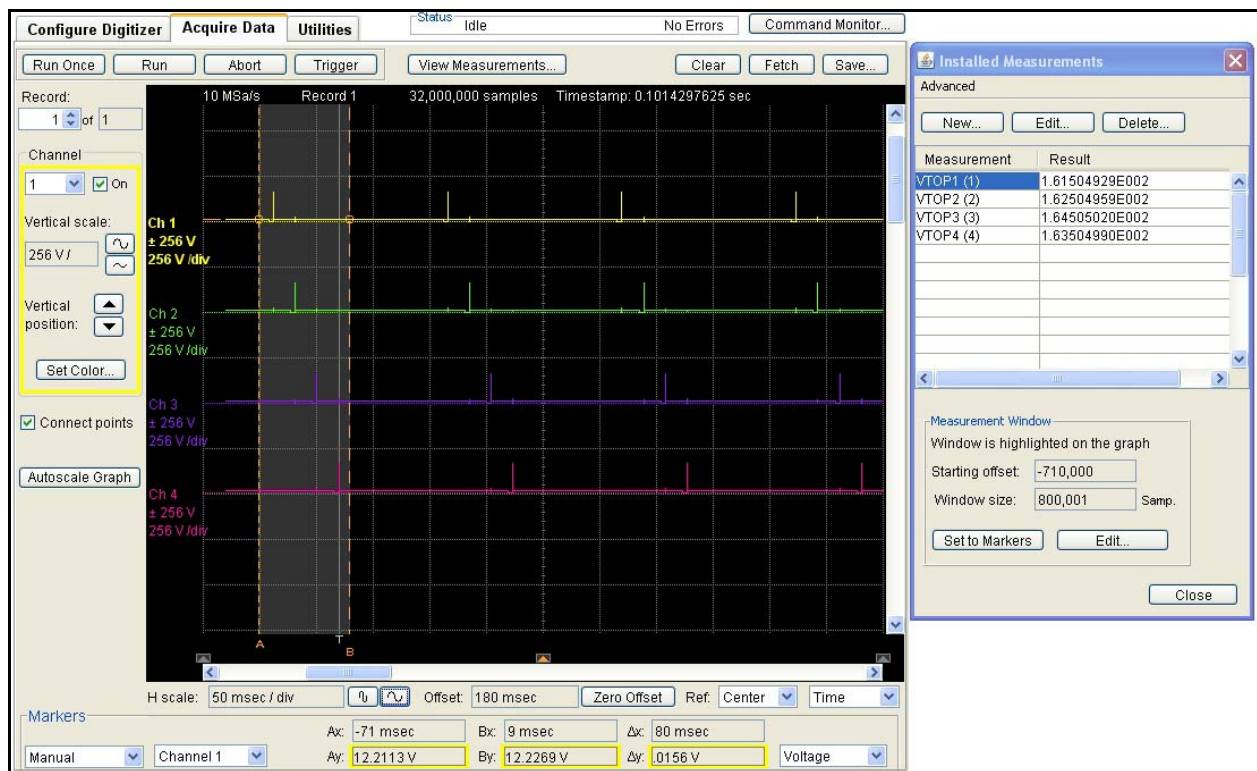

Making a More Accurate Measurement of V_{pk}

In our first measurement of the solenoid pulses, we used immediate triggering. We can take a closer look at the top of each pulse, by changing our acquisition and trigger settings as follows:

- Increasing the sampling rate to 20 MSa/s.
- Take 200,000 samples, with 100,000 pre-trigger samples.
- Trigger on any (of the four channels') rising channel edge, at 50 V, with immediate arming
- Acquire four records in total, one for each pulse.

These settings allow each the digitizer to respond to any channel's rising edge, capturing each solenoid drive's flyback pulse event in a separate record. We can then view each event's record and make subsequent measurements from those individual records.

The waveforms generated from the solenoid drivers will now be captured and stored in a four separate records. The four pulses would be represented in memory as shown below:

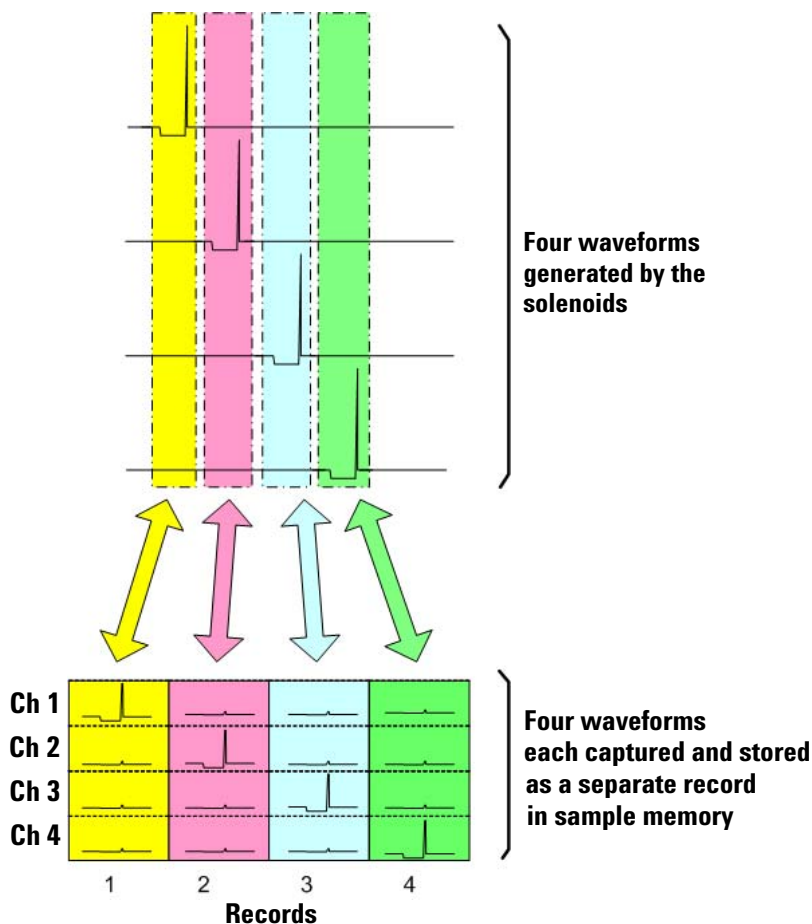

The configuration settings for the revised measurement are shown in the Command Monitor window below.

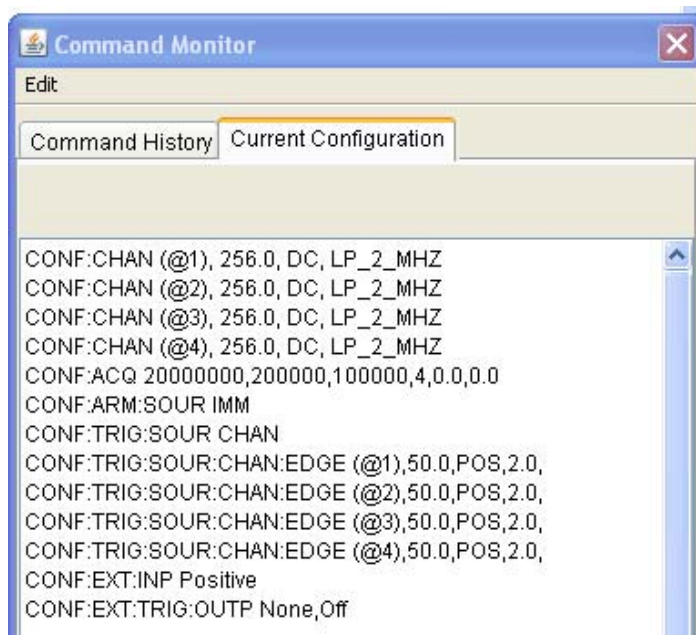

The screenshot shows a window titled "Command Monitor" with a close button in the top right corner. Below the title bar is an "Edit" menu. There are two tabs: "Command History" and "Current Configuration", with "Current Configuration" being the active tab. The main area of the window displays the following configuration settings:

```
CONF:CHAN (@1), 256.0, DC, LP_2_MHZ
CONF:CHAN (@2), 256.0, DC, LP_2_MHZ
CONF:CHAN (@3), 256.0, DC, LP_2_MHZ
CONF:CHAN (@4), 256.0, DC, LP_2_MHZ
CONF:ACQ 20000000,200000,100000,4,0.0,0.0
CONF:ARM:SOUR IMM
CONF:TRIG:SOUR CHAN
CONF:TRIG:SOUR:CHAN:EDGE (@1),50.0,POS,2.0,
CONF:TRIG:SOUR:CHAN:EDGE (@2),50.0,POS,2.0,
CONF:TRIG:SOUR:CHAN:EDGE (@3),50.0,POS,2.0,
CONF:TRIG:SOUR:CHAN:EDGE (@4),50.0,POS,2.0,
CONF:EXT:INP Positive
CONF:EXT:TRIG:OUTP None,Off
```

With these settings, we switch to the **Acquire Data** tab and run the acquisition. By expanding the horizontal scale of the display window to 100 Sa/div, we can easily see the narrow top of the flyback pulse. Taking an average value of that section may provide a more accurate measure of the voltage spike than we made using the built-in Top and Base algorithm on the entire pulse event. We now set a 100 sample measurement window Δx with the horizontal markers, as follows:

- At the bottom right of the **Acquire Data** tab, change Markers from Time to Samples using the drop-down list. Notice that the markers now show the number of samples—not seconds—from the trigger point.
- Click and drag the left marker **A** until Ax: is set on the left side of the pulse top for channel 1 (50 samples after the trigger point).
- Click and drag the right marker **B** until Bx: is set on the right side of the pulse top for channel 1 (150 samples after the trigger point).

We install a Vave measurement for channel 1, click Clear and Run. The display looks like this, providing an accurate measure of V_{pk} for channel 1, as shown below.

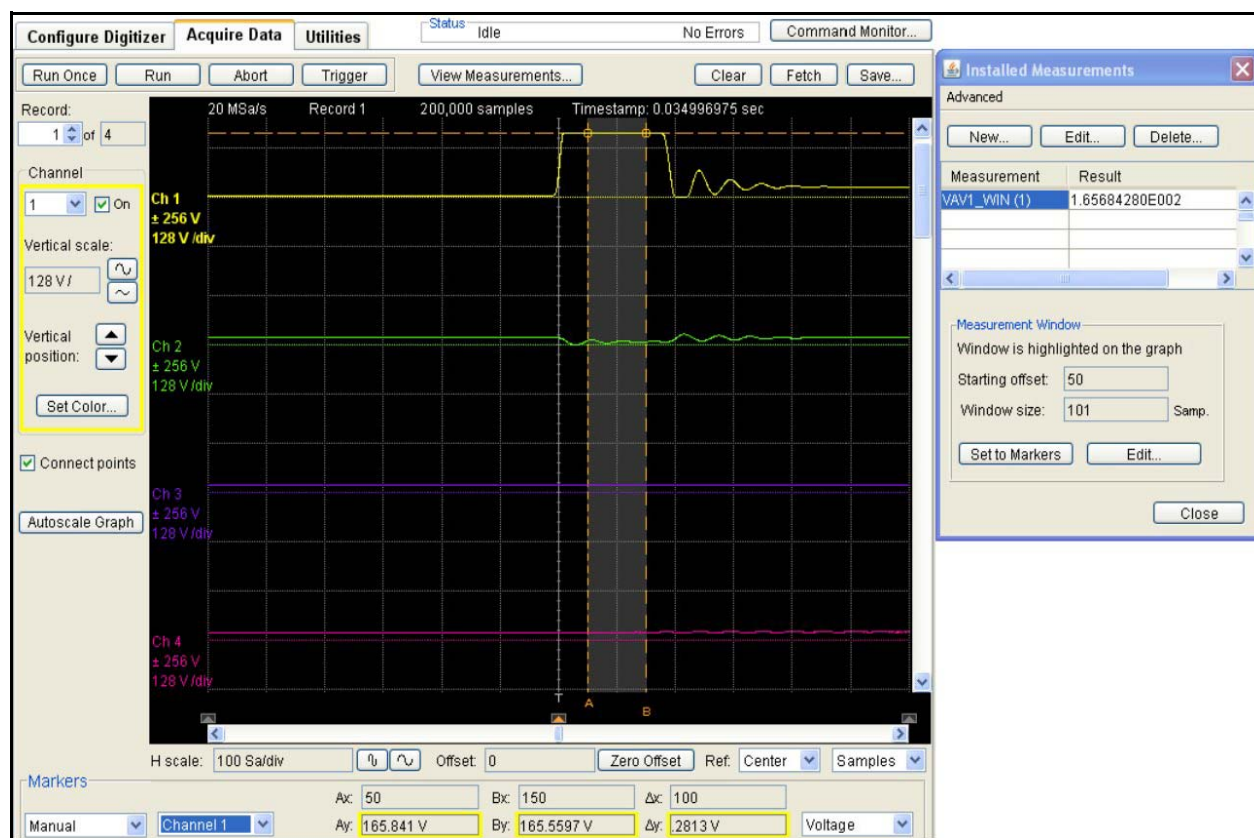

VAV(1)_WIN(1) now provides us an accurate measurement of V_{pk} (165.68 V) for the first solenoid's drive pulse.

Because an installed measurement for any given channel uses a measurement window relative to its own trigger point, using the same markers for channels 2 through 4 will also provide us an accurate measurement of V_{pk} for those channels.

For instance, if we now look at record 2—which recorded the trigger event on channel 2—the trigger point offset is at 0 samples, and the same marker positions used for channel 1 provide a measurement window of channel 2's signal's top.

We install a Vave measurement for record 2, setting the window to the existing markers, and obtain a measurement for VAV(2)_WIN(2), as shown below.

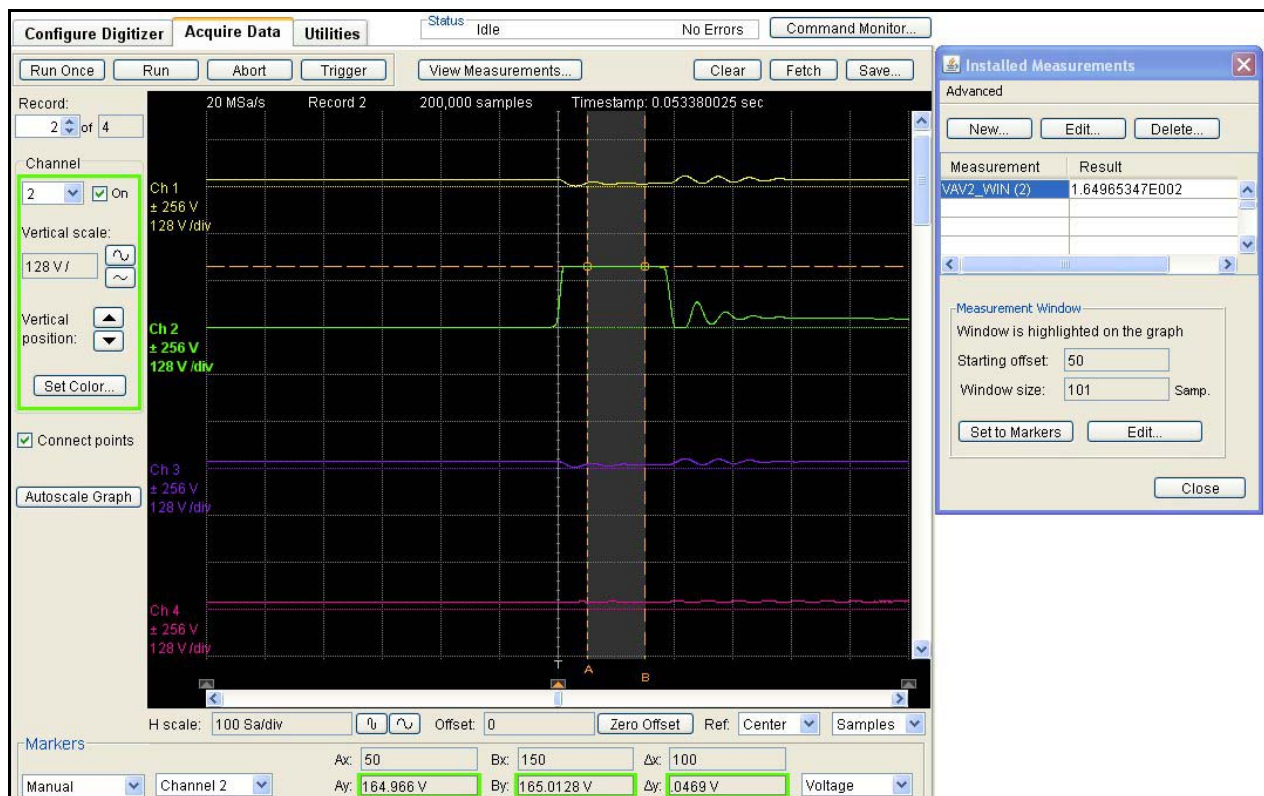

VAV(2)_WIN(2) now provides us an accurate measurement of V_{pk} (164.97 V) for the second solenoid's drive pulse. We can repeat this step to obtain similar V_{pk} measurements for channels 3 and 4.

Help with Host Application Programming

When we manually set markers to create the best measurement window for VTOP, we could have had the Command Monitor window open. We would have seen this current configuration:

The screenshot displays the software interface with three main windows:

- Main Window:** Shows a waveform with two markers, A and B, defining a measurement window. The status bar at the bottom indicates: Offset: 0, Bx: 150, Δx: 100, By: 165.5597 V, Δy: 2813 V, Voltage.
- Installed Measurements Window:** Shows a table with one entry:

Measurement	Result
VAV1_WIN (1)	1.65684280E002

 Below the table, the 'Measurement Window' settings are shown: Starting offset: 50, Window size: 101 Samp.
- Command Monitor Window:** Shows the 'Current Configuration' tab with the following text:

```
CONF:CHAN (@1), 256.0, DC, LP_2_MHZ
CONF:CHAN (@2), 256.0, DC, LP_2_MHZ
CONF:CHAN (@3), 256.0, DC, LP_2_MHZ
CONF:CHAN (@4), 256.0, DC, LP_2_MHZ
CONF:ACQ 20000000,200000,100000,4,0,0,0,0
CONF:ARM:SOUR IMM
CONF:TRIG:SOUR CHAN
CONF:TRIG:SOUR:CHAN:EDGE (@1),50.0,POS,2.0,
CONF:TRIG:SOUR:CHAN:EDGE (@2),50.0,POS,2.0,
CONF:TRIG:SOUR:CHAN:EDGE (@3),50.0,POS,2.0,
CONF:TRIG:SOUR:CHAN:EDGE (@4),50.0,POS,2.0,
CONF:EXT:INP Positive
CONF:EXT:TRIG:OUTP None,Off

MEAS:INST:DEF VAV1_WIN,"MEAS:VAV? (@1),WIND"
MEAS:WIND:DEF 50, 101
MEAS:THR:METH (@1), Percent
MEAS:THR:PERC (@1), 90.0, 50.0, 10.0
MEAS:THR:TOPB:METH (@1), Standard
MEAS:THR:METH (@2), Percent
MEAS:THR:PERC (@2), 90.0, 50.0, 10.0
MEAS:THR:TOPB:METH (@2), Standard
MEAS:THR:METH (@3), Percent
MEAS:THR:PERC (@3), 90.0, 50.0, 10.0
MEAS:THR:TOPB:METH (@3), Standard
MEAS:THR:METH (@4), Percent
MEAS:THR:PERC (@4), 90.0, 50.0, 10.0
MEAS:THR:TOPB:METH (@4), Standard
```

We can cut and paste these commands into our host application program. After using the Web Interface to establish the expected behavior of the solenoid drivers and configure the ideal measurement window settings, we could program automated testing of all four drive outputs and program four measurements, each using a different measurement window but based on the same marker positions from a given channel's trigger.

This is just one example of how visual inspection of the sampled waveform can help you program the digitizer.

Specifying Different Measurement Windows Using Discrete Measurements

In the previous example, we were able to measure V_{pk} from four different records, but using the same measurement window settings Ax and Bx.

When you install measurements, the digitizer will use only one measurement window to calculate all of them, but that window is relative to the trigger point for each acquired record. So we were able to install four measurements of Vave, each on a different channel and each with a different name, but with all four using the same relative window definition.

You can make measurements of the other characteristic parameters from the data captured when sampling the four-channel flyback events. For instance, you could measure V_{pk} , t_{on} , V_{dson} , t_{off} , and t_{pw} individually. To do this, you could establish an individual measurement window for each measurement you need to make. For instance:

- Use the Fall Time measurement with one window to calculate t_{on} .
- Use the Vave measurement with a second window to calculate V_{dson} .
- Use the Rise Time measurement with a third window to calculate t_{off} .
- Use the Pos Pulse Width measurement with a fourth window to calculate t_{pw} .

However, installed measurements for a given acquisition must use the same measurement window. We could do several separate acquisitions, each with a different set of installed measurements and window specifications, but this would increase testing time.

We make all needed measurements using a single acquisition cycle, by using *discrete measurements*. Discrete measurements are not automatically performed immediately after the acquisition is complete; your host application must send an individual query for each one.

Once data is acquired and in sample memory, it remains there until the next INITiate command is sent. While the data is available, you can repeatedly fetch it or perform discrete measurements.

After inspecting the waveform once and learning how you would set each measurement window, you can program a discrete measurement for each waveform parameter of interest, acquire data once, and then perform a programmed set of discrete measurements on that data.

For example, the discrete measurement commands (beginning with the window definition) needed to return the desired values of V_{pk} , and the measurement results we obtained, are:

Command Sequence	Measurement Value
MEAS:WIND:DEF 50,101	
MEAS:VAV? (@1), WIND, 1	164.841
MEAS:VAV? (@2), WIND, 2	165.043
MEAS:VAV? (@3), WIND, 3	167.051
MEAS:VAV? (@4), WIND, 4	165.134

This close-up view of V_{pk} was obtained by adjusting the horizontal and vertical scales from the measurement on page 53, and provides a better view of how accurately you can specify a window using this visual tool.

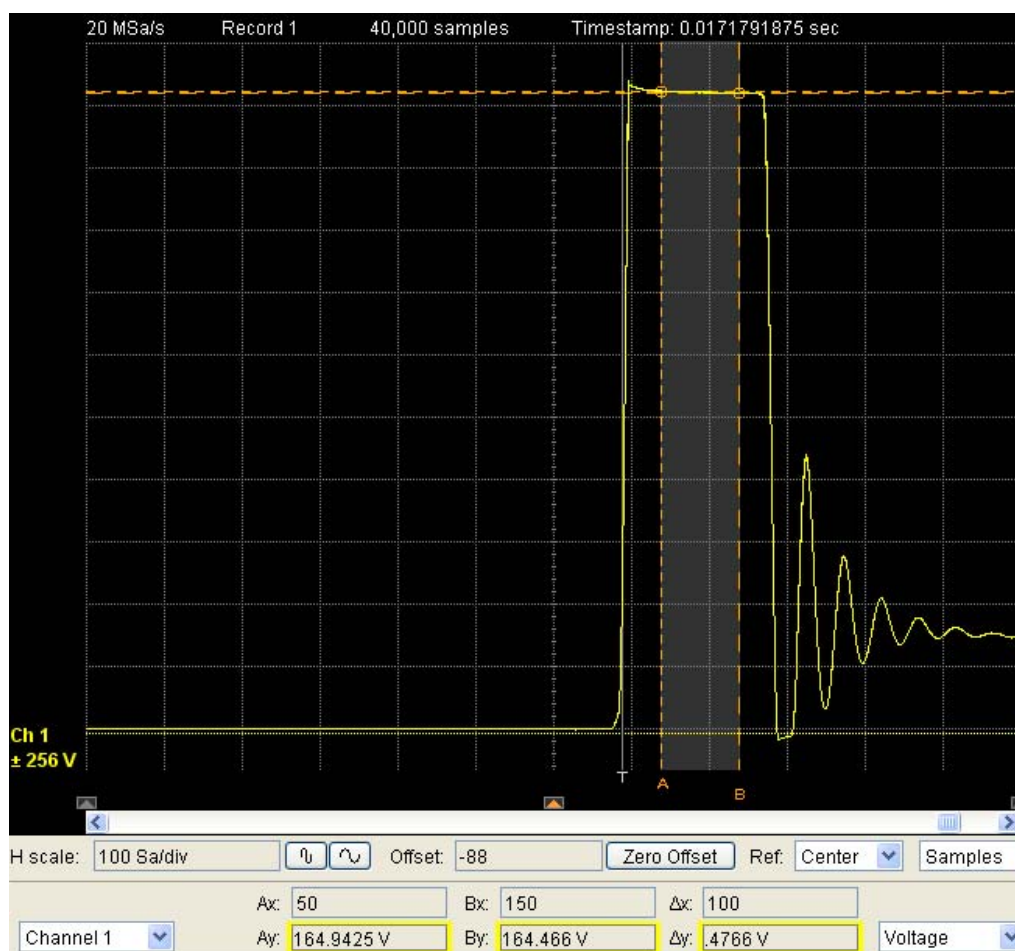

The discrete measurement commands needed to return the desired values of V_{dson} , and the measurement results we obtained, are:

Command Sequence	Measurement Value
MEAS:WIND:DEF -480,400	
MEAS:VAV? (@1), WIND, 1	1.146
MEAS:VAV? (@2), WIND, 2	1.065
MEAS:VAV? (@3), WIND, 3	1.087
MEAS:VAV? (@4), WIND, 4	1.542

Notice that the command sequence for measuring V_{dson} is the same as for V_{pk} , except that the measurement window is different. In each case, we are taking an average value from a relatively flat section of the waveform. In this case, we end our measurement window 80 samples before the trigger point. The close-up view of that window is shown below.

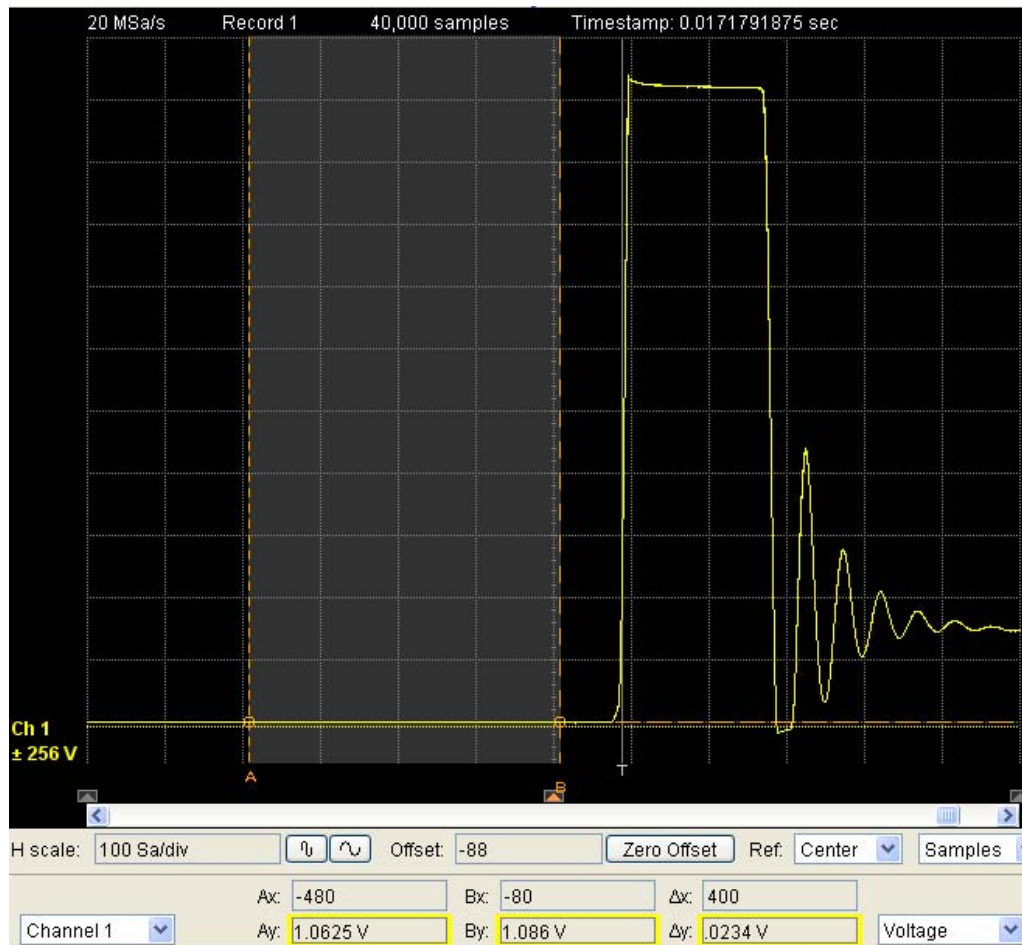

Also of interest is that we were able to obtain accurate measures of the low-voltage value V_{dson} , on the same ± 256 V scale which we needed to capture the high-voltage spike.

The discrete measurement commands needed to return the desired values of t_{pw} , and the measurement results we obtained, are:

Command Sequence	Measurement Value
MEAS:WIND:DEF -100,550	
MEAS:PWID? (@1), 1, 1	1.00E-05
MEAS:PWID? (@2), 1, 2	9.59E-06
MEAS:PWID? (@3), 1, 3	9.80E-06
MEAS:PWID? (@4), 1, 4	9.81E-06

This window is illustrated below.

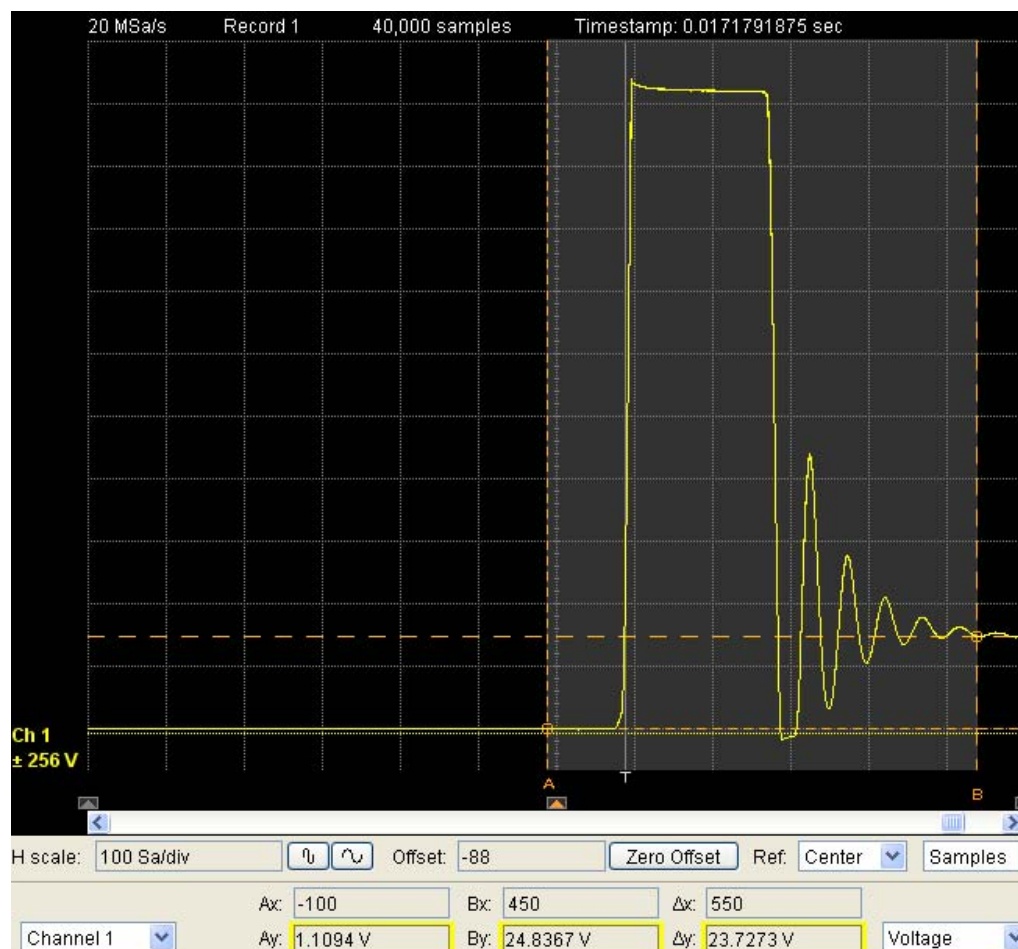

Even with a generous-sized window (several hundred samples in duration) extending well beyond the pulse and including some of the ringing after the pulse, the digitizer’s on-board measurement engine correctly assessed the expected 10 microsecond pulse width.

Example 3: Digitizing Simultaneous Airbag Deployment Signals

For an application where you need to take synchronous samples from more than four channels, and record information about these samples as if they were sourced by the same digitizer, you can configure multiple L4532A/34A digitizers to be armed and triggered synchronously. In effect, four 4-channel digitizers thus configured act as a time-synchronous, single 16-channel digitizer.

Learning Objectives

In this example, you will learn how to:

- Physically synchronize (frequency-lock and phase-lock) the internal measurement reference clocks and timestamp counters in four L4534A digitizers.
- Program the synchronized L4534A digitizers for simultaneous triggering.

Test Setup

Automotive airbag deployment schemes are continually evolving. Many cars now have multiple airbags, multiple sensors which determine the need for deployment, and multiple stages of deployment depending on the severity of a sensed impact. The control module must reliably send each airbag squib—or ignitor—a pulse of sufficient amplitude (30-40 V) and total energy to cause ignition, usually within 10-20 ms of the impact. The control system is typically centralized, with accelerometers in the control module which respond to the impact event.

One method of testing the deployment system requires physically locating the control module on a *shaker table*, which generates a precise g-force shock to simulate sudden deceleration. An ECU mounted on the shaker table responds to the shock; so does a co-located accelerometer which outputs a 2V pulse when the shock is detected. This pulse can serve as the trigger event; then a multiple-channel digitizer records both the accelerometer pulse and the output waveforms from the control module to the individual squibs. This allows test results which accurately simulate and document the control module's response characteristics, including its response to the shock and the relative timing and pulse energy for each output signal.

The illustrations that follow assume that we must record the time of the accelerometer pulse as t_0 , then digitize twelve (squib deployment) output signals from the control module. The example will focus primarily on physical configuration of the digitizers and the program commands necessary to synchronize and trigger the digitizers.

Physical Configuration of Multiple Digitizers

The following physical interconnection steps are necessary to prepare for synchronization of the four digitizers:

- 1 Connect the **10 MHz Out** (external clock reference output) from digitizer #1 to the **10 MHz In** (external clock reference input) BNC connector for digitizers #2 through #4. This physical connection allows the digitizers to remain in frequency-lock and phase lock once synchronized.
- 2 Connect all digitizers' **Trig In/Out** (bidirectional external trigger) BNC connectors together in parallel. This physical connection allows one digitizer to send the sync pulse to the remaining digitizers over its trigger bus.
- 3 Connect the accelerometer output to digitizer #1, channel 1.
- 4 Connect the twelve ECU squib outputs to digitizers #2, #3 and #4; channels 1 through 4.

The clock and trigger pulse connections are shown below.

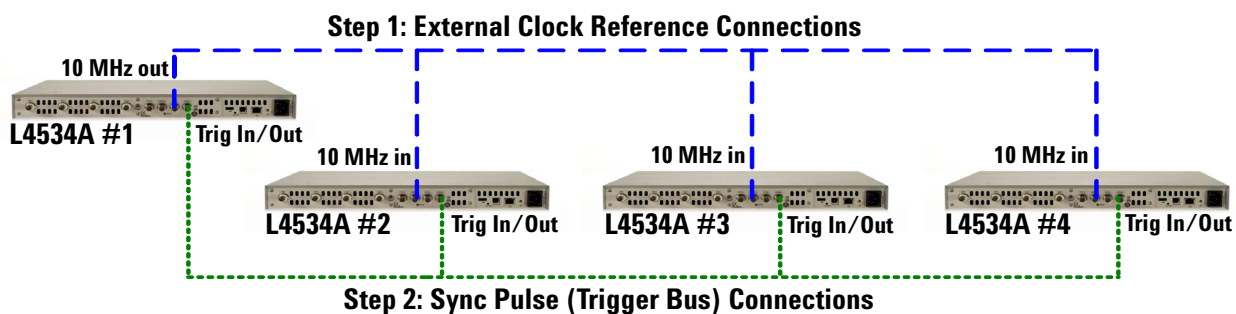

You must set the sync pulse (trigger bus) termination correctly for all four units; this is done by software (see [step 5 on page 64](#)). The resulting internal circuit is shown below.

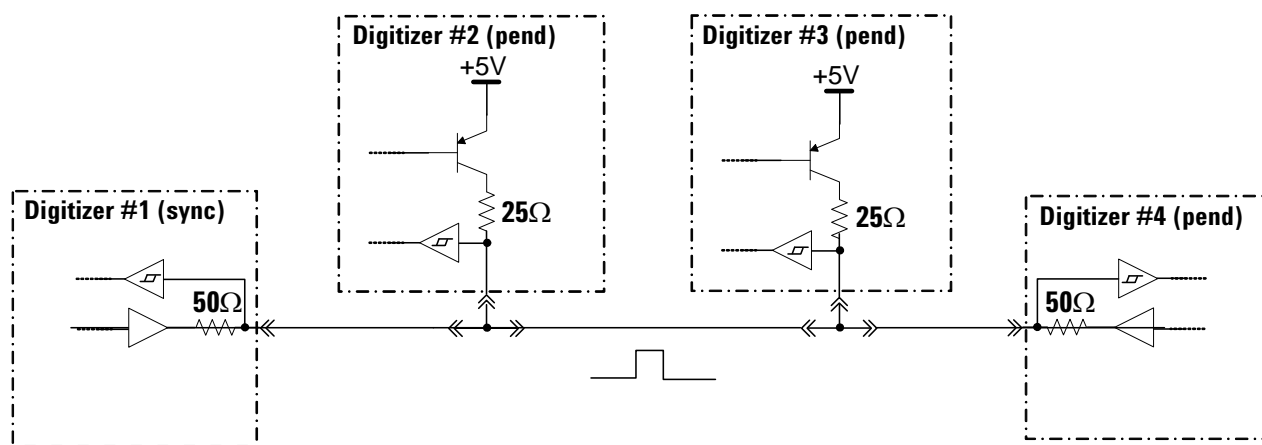

Programming To Synchronize Multiple Digitizers

You must take the following programming steps to configure the digitizers for sampling, before sending the commands which achieve synchronization.

Before Synchronization

- 1 Set digitizers #2 through #4 to lock to an external reference clock:

```
CONF:ROSC:EXT
```

- 2 Set acquisition and channel attributes on all four digitizers before synchronization; once digitizer synchronization is completed, changing acquisition and channel attributes may disrupt external synchronization and generate an error message.

- a Set the acquisition attributes on all four digitizers. (In practice, you can set different sampling rates on each channel, but for this example, 1 MSa/s works for all inputs we will sample.) The following command sets the sample rate at 1 MSa/s, 1000 pre-trigger samples and 50,000 post-trigger samples:

```
CONF:AQC:ATTR: 1000000,1000,50000,
```

- b Set the channel attributes.

For digitizer #1, the following command sets the range for channel 1 to 4 V:

```
CONF:CHAN:ATTR (@1:4),4
```

For digitizers #2 through #4, set the range to 64 V:

```
CONF:CHAN:ATTR (@1:4),64
```

- 3 Set all four digitizers in continuous timestamp mode:

```
CONF:TRIG:TIME CONT
```

- 4 Set digitizers #2 through #4 to lock to an external reference clock:

```
CONF:ROSC:EXT
```

- 5 Set the port termination impedance for the four digitizers, so that unit one can correctly send a sync pulse and units two through four can correctly accept it.

- a Terminate the two “end” units on the parallel trigger bus to 50Ω:

```
CONF:EXT:INP:POS
```

```
CONF:EXT:TRIG:OUTP NONE, POS_50
```

- b Terminate the two “middle” units on the parallel trigger bus to 25Ω:

```
CONF:EXT:INP:POS
```

```
CONF:EXT:TRIG:OUTP NONE, POS_25_W_OR
```

To Achieve and Verify Synchronization

- 1 Digitizers #2 through #4 will receive the synchronizing pulse on their trigger bus. Set these to be *pending* synchronization:

```
SYST:SYNC:EXT PEND
```

- 2 Digitizer #1 will send the synchronizing pulse on its trigger bus, as well as be pending receipt of that pulse. Set it to SYNC:

```
SYST:SYNC:EXT SYNC
```

When the SYST:SYNC:EXT SYNC command is sent, digitizer one will immediately issue a synchronizing pulse, both to itself and to the other three digitizers via the trigger bus. When each digitizer receives the synchronizing pulse, its timestamp counter resets to zero.

- 3 Verify the synchronization status of each digitizer:

```
SYST:SYNC:EXT?
```

The query will return SYNC for any digitizer once it has successfully received a synchronizing pulse.

To Re-configure the Trigger Bus

Once synchronized, the units will remain in sync; you can then reconfigure each digitizer's **Trig IN/Out** connector to receive or send a trigger pulse.

- 1 For digitizer #1, set it for immediate arming, to accept a rising edge trigger at 2V on channel 1, and to output a trigger pulse to units #2 through #4:

```
CONF:ARM:SOUR IMM
CONF:TRIG:SOUR CHAN
CONF:TRIG:SOUR:CHAN:EDGE (@1),2
CONF:EXT:TRIG:OUTP TRIG, POS_50
```

For digitizers #2 through #4, set them for immediate arming and external triggering:

```
CONF:ARM:SOUR IMM
CONF:TRIG:SOUR EXT
CONF:EXT:TRIG:INP POS
```

Running the Measurement

The trigger bus connections you made on [page 63](#) to accept the synchronization pulse also work to allow digitizer #1 to send a trigger pulse to digitizers #2 through #4, once it is triggered by the accelerometer.

With the digitizers configured for measurement, synchronized, and re-configured for triggering, you would run the test in this order:

```
INIT
apply shock to shaker table
```

The digitizers should all collect simultaneous samples on all channels, including 1000 pre-trigger samples and 50,000 post-trigger samples per channel. Digitizer #1's channel 1 will record the accelerometer pulse. Digitizers #2 through #4 will record the 12 squib output signals. All 13 channels will have their trigger referenced to the same timestamp.

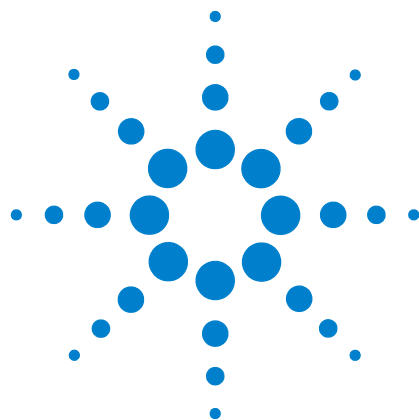

4 Digitizer Programming and PC Connection

This chapter provides an overview of the digitizer's command language, and detailed instructions for establishing and configuring a connection to your host computer

Programming the Digitizer	68
Introduction to the Command Language	68
Syntax Conventions	69
Parameter Types	70
The Channel and Channel List Parameters	71
Querying Parameter Settings	71
VERBose Queries	72
IEEE-488.2 Common Commands	72
Command Terminators	72
Parameter Coercion	73
Settings Conflicts	73
Stale Data Errors	74
Connecting the L4532A/34A to Your Computer	75
Connecting over USB	75
Connecting over LAN	75
Selecting a LAN Network	76
Private LAN Considerations	76
Site LAN Considerations	77
Configuring a LAN Interface	77
Communicating over the LAN	88



Programming the Digitizer

The command language for the L4532A/34A is an ASCII-based instrument command language for digitizers. Complete syntax rules and examples can be found in the *Agilent L4532A/34A Command Reference*, an on-line help file that is provided on the *Product Reference CD* supplied with the digitizer or can be downloaded from the Agilent website at www.agilent.com/find/L4532A. or www.agilent.com/find/L4534A.

Introduction to the Command Language

The digitizer commands are based on a hierarchical tree system in which associated commands are grouped together under a common node or root to form subsystems. A portion of the MEASure subsystem is shown below to illustrate the tree system.

```
MEASure:  
  FALL:  
    PERiod:  
    FREQuency  
  RISE:  
    PERiod:  
    FREQuency
```

In the command tree above, MEASure is the root keyword of the command, FALL and RISE are second-level keywords, and PERiod and FREQuency are third-level keywords. A colon (:) separates a command keyword from a lower-level keyword.

Syntax Conventions

The format used to send commands—used throughout the remainder of this chapter to illustrate the digitizer's features—is summarized below:

The command syntax shows most commands (and some parameters) as a mixture of uppercase and lowercase letters. The uppercase letters indicate the abbreviated spelling for the command. For shorter program lines, you can send the abbreviated form. For better program readability, you can send the long form. For example, in the command `MEASure:INSTall:DELeTe {<label>|ALL}`, `MEAS` and `MEASure` are both acceptable forms. You can use uppercase or lowercase letters. Therefore, `MEASure`, `meas`, and `Meas` are all acceptable. Other forms, such as `MEA` and `MEASUR`, are not valid and will generate an error.

- Braces ({ }) enclose the parameter choices for a given command string. The braces are not sent with the command string.
- A vertical bar (|) separates multiple parameter choices for a given command string. For example, {<label>|ALL} in the above command indicates that you can specify a <label>, or "ALL". Do not send the bar with the command string.
- Italicized angle brackets (< >) indicate that you must specify a value for the enclosed parameter. The brackets are not sent with the command string. You must specify a value for the parameter (for example, `MEASure:INSTall:DELeTe "MEZ_25"`) unless you select one of the other options shown in the syntax (for example, `MEASure:INSTall:DELeTe ALL`).
- Some parameters are enclosed in square brackets ([]). This indicates that the parameter is optional. The brackets are not sent with the command string. If you do not specify a value for an optional parameter, the digitizer chooses a default value.
- A colon (:) separates a command keyword from a lower-level keyword. You must insert a blank space to separate a parameter from a command keyword. If a command requires more than one parameter, you must separate adjacent parameters using a comma, as in `MEASure:THResholds:ABSolute (@1:4),90,50,10`
- A semicolon (;) is used to separate commands within the same subsystem and can also minimize typing. For example, sending the command string `FORM:INT ASC; BORD NORM` is the same as sending the two separate commands `FORM:INT ASC` and `FORM:BORD NORM`.
- Use a semicolon and a colon in series to link commands from different subsystems. For example, in the command string `INIT;:TRIG IMM`, an error is generated if you do not use both the colon and semicolon between `INIT` and `TRIG`.

Parameter Types

The command language defines four data formats to be used in program messages and response messages.

Numeric Parameters

Commands that require numeric parameters will accept all commonly used decimal representations of numbers including optional signs, decimal points, and scientific notation. If a command accepts only certain specific values, the digitizer will automatically round the input numeric parameters to the accepted values.

Because the parser is case-insensitive, there is some confusion over the letter "M" (or "m"). For your convenience, the digitizer interprets "mV" (or "MV") as millivolts, but "MHZ" (or "mhz") as megahertz. Likewise "MO" (or "mO") is interpreted as megohms. You can use the prefix "MA" for mega. For example, "MAV" is interpreted as megavolts.

Discrete Parameters

Discrete parameters are used to program settings that have a finite number of values, for example: (IMMediate, EXTERNAL, SOFTWARE). These parameters have a short form and a long form just like command keywords. You can mix uppercase and lowercase letters. When you query a discrete setting, the digitizer will always return the short form in all uppercase letters.

Boolean Parameters

Boolean parameters represent a single binary condition that is either true or false. For a false condition, the digitizer will accept OFF or 0. For a true condition, the digitizer will accept ON or 1. When you query a Boolean setting, the digitizer will always return 0 or 1.

ASCII String Parameters

String parameters can contain virtually any set of ASCII characters. A string must begin and end with matching quotes; either with a single quote or a double quote. You can include the quote delimiter as part of the string by typing it twice without any characters in between.

The Channel and Channel List Parameters

The MEASure queries and some other commands require you to select one specific channel. One example is the query

```
MEASure:FALL:FREQuency[:VERBoSe]?
(@<channel>)[,<num_edge>[,<rec_num>]]
```

For this and all other commands using the *<channel>* parameter, use this parameter to select a single channel to which the command applies. You must specify an unsigned integer from 1 to 4 (for the 4-channel model L4534A only; valid values for the 2-channel model L4532A are 1 and 2). A valid example of (@<channel>) is:

(@1) command applies to channel 1 only

Many commands for the digitizer require you to specify a single channel or a *channel list*. One example is the command

```
[CONFigure:]CHANnel[:ATTRibutes]
(@<chan_list>),<range>[,<coupling>[,<filter>]]
```

For all commands using the *<chan_list>* parameter, you will use that parameter to select the channel(s) to which the command applies. You may specify a single channel as described above, a comma-separated list in ascending order, or a range of channels in ascending order.

Except for four FETCh and READ commands, valid examples of (@<chan_list>) are:

- (@2) command applies to channel 2 only
- (@1,4) command applies to channels 1 and 4
- (@1:3) command applies to channels 1 through 3

For the FETCh:WAVEform:ADC, FETCh:WAVEform:VOLTage, READ:WAVEform:ADC, and READ:WAVEform:VOLTage commands, you may specify one, two or four channels, but not three.

Querying Parameter Settings

You can query the current value of most parameters by adding a question mark (?) to the command.

For example, the command CONF:CHAN:PROT:REL (@1:4),1 turns on the protection relay for channels 1 through 4. You can then query the protection setting by sending the command CONF:CHAN:PROT? (@1:4).

The *Agilent L4532A/34A Command Reference* lists the allowable query forms for applicable commands, with examples of the syntax and return format for each query.

VERBose Queries

All measurement queries (for example: MEASure:VMAX[:VERBose]?) have two *forms*; you select one or the other by using or not using the VERBose keyword.

The standard form does not use the VERBose keyword; the digitizer returns only the measurement result.

The VERBose form uses the VERBose keyword; the digitizer returns six values. The first is the measurement result. The second is a *<return_code>*; it provides information about the measurement result which may be useful in debugging. The last four are *markers* similar to what many oscilloscope displays provide (the X and Y coordinates of the beginning and ending points of the measurement). The X coordinates *<Ax>* and *<Bx>* indicate time locations; the Y coordinates *<Ay>* and *<By>* indicate voltages.

This manual provides syntax and examples for each of the standard form measurements. The VERBose form's marker parameters vary with each measurement. Complete details describing the return codes and marker definitions for VERBose queries are documented in the *Agilent L4532A/34A Command Reference*.

IEEE-488.2 Common Commands

The IEEE-488.2 standard defines a set of common commands that perform functions such as reset, self-test, and status operations. Common commands always begin with an asterisk (*), are three letters in length, and may include a question mark to indicate a query. They may also include parameters. The command keyword is separated from the first parameter by a blank space.

Command Terminators

A command string sent to the digitizer must terminate with a new line (<NL>) character. The IEEE-488 End-Of-Identify (EOI) message is interpreted as a <NL> character and can be used to terminate a command string in place of a <NL> character. A carriage return followed by a <NL> is also accepted. Command string termination will always reset the current command path to the root level.

For every query sent to the digitizer, the digitizer terminates its response with a <NL> or line-feed character (EOI). The program must read this <NL> in the response before another command is sent to the digitizer, or an error will be generated.

Parameter Coercion

Many command parameters allow you to set numeric values over a range, but the digitizer may only explicitly support discrete numeric values within that range. If you set a parameter that is within range but not an explicitly supported value, the digitizer will *coerce* the value (that is, change it to the closest supported value). It may coerce the value up or down; the specific behavior is documented in the *Agilent L4532A/34A Command Reference*.

Example: If you set sample rate to 25000 Sa/s by issuing the command `CONF:ACQ:SRATE 25000`, the digitizer will coerce the value up to 50,000 SA/s.

When coercion occurs, a Coerced Data Event bit is set in the Standard Operation Register. You may wish to query the parameter(s) you set which caused the coercion event; determine if the coerced value is acceptable for your application, and make any necessary changes. See the `STATUS:OPERATION:EVENT?` query in the *Command Reference* to determine how to detect this event.

Settings Conflicts

It is possible to set a configuration parameter which is an allowable value, but causes a conflict with previous settings. When possible, the digitizer will coerce one of the configuration settings to resolve the conflict, and will generate a settings conflict error.

Example: The arm and trigger sources cannot simultaneously be set to `EXTERNAL`. If you had previously set the arm source to `EXTERNAL`, then subsequently set the trigger source to `EXTERNAL`, the digitizer will coerce the arm source to `IMMEDIATE`.

In some cases, the digitizer will deny the change causing a settings conflict and generate an error message. These cases are based on precedence rules which subordinate some settings to others.

Example: If you had previously set the trigger source to `EXTERNAL`, then subsequently set the arm source to `EXTERNAL`, the digitizer will deny the change and generate an error.

The *Agilent L4532A/34A Command Reference* documents each specific instance of settings conflict and the resulting behavior.

Stale Data Errors

Sample data or measurement data can become stale; that is, it can become invalid based on changes in digitizer settings or conditions. Attempts to read sample or measurement data once erased will result in a Stale Data Error.

What Causes Stale Sample Data

- Sample data stored after an acquisition is erased whenever the `INITiate` command is sent (or one of the `READ:WAVEform` commands, which sends an implicit `INITiate`).
- A `*RST` command or cycling power will erase sample data.
- Sending an `ABORT` command may cause some data to become stale, but you should be able to retrieve any complete records or completed samples from partial records. Use the `FETCh:WAVEform:RECORD:PREamble?` query to determine what data is available after an `ABORT`.
- Sample data can become stale if you reconfigure the digitizer. This is intuitive, since when you change acquisition or channel attributes, you change the parameters on which the previously acquired data was based. Changing arm or trigger source or other configuration parameters may also cause stale data. If in doubt, retrieve any necessary sample data before making configuration changes.

What Causes Stale Measurement Data

- Results of installed measurements evaluated and stored after an acquisition are erased whenever the `INITiate` command is sent (or one of the `READ:WAVEform` commands, which sends an implicit `INITiate`).
- A `*RST` command or cycling power will erase measurement data.
- Sending an `ABORT` command will preclude new measurements from being evaluated, as this only occurs after acquisition completes normally.
- Measurement data can become stale if you reconfigure the digitizer. This is intuitive, since when you change acquisition, channel, or measurement (label, window or threshold) attributes, you change the parameters on which the previously evaluated measurements were based. If in doubt, retrieve measurements before making configuration changes. If you only change window or threshold values, you can re-run installed measurements based on the existing sample data, using the `MEASure:INSTall:RUN` command.

Connecting the L4532A/34A to Your Computer

You may connect the digitizer to your PC by USB or LAN. This section provides connection instructions and network design suggestions.

Connecting over USB

Programming access to the L4532A/34A digitizer is available through the digitizer's USB interface. The USB B-plug connector is located on the rear panel of the L4532A/34A. Do not try to use the USB A-plug port marked **Service Only** to control the digitizer.

- 1 If you have not already done so, install the Agilent IO Libraries Suite from the Automation-Ready CD-ROM that is shipped with your digitizer.
- 2 Connect a USB cable between the USB ports on the digitizer and your computer, then turn the digitizer on.
- 3 Run the Connection Expert utility of the Agilent IO Libraries Suite. The computer will automatically recognize the digitizer within several seconds.
- 4 You can now use Interactive IO within the Connection Expert to communicate with your digitizer, or you can program your digitizer using the various programming environments.

Connecting over LAN

Programming access to the digitizer is also available through the digitizer's LAN interface. The LAN connector is located on the rear panel of the digitizer.

To use a LAN, you must:

- Choose between isolated and site networking needs.
- Connect the digitizer to your PC or network with appropriate network cabling.
- Set or allow the digitizer to automatically set the LAN parameters.

Selecting a LAN Network

This section contains information for choosing a network configuration (a private or site LAN) in which to use the L4532A/34A.

For the purposes of this user's guide, a private (isolated) LAN network is defined as a network configuration in which instrument access is a direct connection between the computer and the instrument, or to multiple instruments connected via a dedicated router or switch. A site (company-wide) LAN is defined as a network in which instrument access is available to many users at on-site and remote locations.

The instrument's application and/or your company's IT (Information Technology) department may have guidelines that help decide the type of network. If a network configuration has not been determined, refer to the following considerations concerning each type.

Private LAN Considerations

Among the basic parameters of a private LAN network to consider are security, performance, reliability, and IP address availability.

Security: a private network generally involves a direct connection between the computer and the instrument, or to multiple instruments using switches or routers. Access to the instrument is limited to users on the private network, as opposed to users on a site network that could locate and access the instrument from any location. Private networks can reduce the possibility of tests being disrupted by unplanned or unauthorized access. Code generation for test systems on a private network is often simplified as provisions against unauthorized users may not be required.

Performance: test systems where large amounts of data are transferred usually have faster throughput on a private network. On a site network, heavy and unpredictable LAN traffic affects each instrument (node) on the network. The impact on a test system is that repeatability is difficult to achieve as latencies are difficult to account for.

Reliability: private networks are fundamentally more reliable than site networks as they host fewer users and are less complex than site networks. Private networks are isolated from conditions that could bring down (crash) a site network.

IP Address Availability: Every instrument (node) on a LAN (private or site) has an IP (Internet Protocol) address. Due to the expanding use of the internet, the number of site network IP addresses available is limited. By using a router with Dynamic Host Configuration Protocol (DHCP) capability on a private network, the router can assign an IP address to each instrument thus creating a sub-network (subnet) that does not consume site IP addresses.

Site LAN Considerations

For applications requiring access by many users or by users at distributed sites, a site LAN network is required. In addition to supporting multiple users, site LANs often offer the advantage of being maintained by IT departments.

Configuring a LAN Interface

By default, LAN and DHCP are enabled on the digitizer. However, you may choose to manually set any of the following configurable parameters, as described in the subsections below.

- DHCP ON/OFF (see [“Enabling or Disabling DHCP”](#) on page 78)
- DNS Server (see [“Setting the LAN DNS Server Address”](#) on page 79)
- Domain Name (see [“Setting the LAN Domain Name”](#) on page 80)
- Default Gateway (see [“Setting the LAN Default Gateway Address”](#) on page 81)
- Host Name (see [“Setting the LAN Host Name”](#) on page 82)
- IP Address (see [“Setting the LAN IP Address”](#) on page 83)
- Subnet Mask (see [“Setting the LAN Subnet Mask”](#) on page 84)
- Telnet Prompt (see [“Setting the Telnet Command Prompt”](#) on page 86)
- Telnet Welcome Message (see [“Setting the Telnet Welcome Message”](#) on page 87)

If you change the DHCP, DNS, Default Gateway, Host Name, IP Address, or Subnet Mask; you must send an additional command to update LAN settings (see [“LAN Configuration Changes and LAN Reset”](#) on page 87).

Enabling or Disabling DHCP By default, local access network (LAN) connectivity with DHCP (Dynamic Host Configuration Protocol) is enabled on the digitizer. DHCP (Dynamic Host Configuration Protocol) is a protocol for automatically assigning a dynamic IP address, Subnet Mask, and Default Gateway to a device on a network, and is typically the easiest way to configure your digitizer for remote communication using the LAN interface.

- If you change the DHCP setting, you must cycle power on the digitizer to activate the new setting.
- When DHCP is enabled (factory setting), the digitizer will try to obtain an IP address from a DHCP server. If a DHCP server is found, it will assign a dynamic IP address, Subnet Mask, and Default Gateway to the digitizer. The DHCP server may also assign the DNS address, and may change the specified Host Name if a manually specified Host Name is already in use.
- When DHCP is disabled or unavailable, the digitizer will use the static (user-specified) IP address, Subnet Mask, and Default Gateway during power-on.
- If a DHCP LAN address is not assigned by a DHCP server, then a static IP address will be assigned after approximately one minute.

To enable or disable DHCP, use this command:

```
SYSTem:COMMunicate:LAN:DHCP <mode>
```

<mode> can be OFF, ON (default).

Example: The following command disables DHCP.

```
SYST:COMM:LAN:DHCP OFF
```

Setting the LAN DNS Server Address The Domain Name Service (DNS) is an Internet service that translates Domain names into IP addresses. Contact your network administrator to determine whether DNS is being used and for the correct address.

- If you change the DNS address, you must cycle power on the digitizer to activate the new setting.
- If DHCP is enabled (SYSTem:COMMunicate:LAN:DHCP ON), it will assign the DNS address; if not, it will use the static address you assign.
- The DNS Server address is stored in non-volatile memory; it does not change when power has been off or after a Factory Reset (*RST) command.

To set a static DNS address, use this command:

```
SYSTem:COMMunicate:LAN:DNS "<address>"
```

<address> is a required parameter. You must specify a quoted string in four-byte dot notation, where each of the four numbers is a base ten number from 0 to 255. The default value is "0.0.0.0".

Example: The following sets a static DNS server address.

```
SYST:COMM:LAN:DNS "168.012.000.001"
```

Setting the LAN Domain Name The Domain Name is a string of up to 63 characters, which is translated into an IP address.

- If you change the Domain Name, you must cycle power on the digitizer to activate the new setting.
- If Dynamic Domain Name System (DNS) is available on your network and your digitizer uses DHCP, the Domain Name is registered with the Dynamic DNS service at power-on.
- If DHCP is enabled (SYSTem:COMMunicate:LAN:DHCP ON), the DHCP server can change the specified Domain Name.
- The Domain Name is stored in non-volatile memory; it does not change when power has been off or after a Factory Reset (*RST command).

To set a static Domain Name, use this command:

```
SYSTem:COMMunicate:LAN:DOMain "<address>"
```

<address> is a required parameter. You must specify a string of up to 63 characters. The first character must be a letter (A-Z), but the remaining 62 characters can be letters, numbers (0-9), dashes ("-"), or periods ("."). Blank spaces are not allowed.

Example: The following sets a static Domain Name.

```
SYST:COMM:LAN:DOM "AgilentTestL4532A.com"
```

Setting the LAN Default Gateway Address The Default Gateway allows the digitizer to communicate with systems that are not on the local subnet. The Default Gateway is where packets that are destined for a device not on the local subnet are sent, as determined by the Subnet Mask setting.

Contact your network administrator to determine whether a gateway is being used and for the correct address.

- If you change the Default Gateway, you must cycle power on the digitizer to activate the new setting.
- If DHCP is enabled (SYSTEM:COMMUNICATE:LAN:DHCP ON), the specified Default Gateway is not used. However, if DHCP is disabled, the specified (static) Default Gateway will be used.
- The Default Gateway is stored in non-volatile memory; it does not change when power has been off or after a Factory Reset (*RST command).

To set a static Default Gateway, use this command:

```
SYSTEM:COMMUNICATE:LAN:GATEWAY "<address>"
```

<address> is a required parameter. You must specify a quoted string in four-byte dot notation, where each of the four numbers is a base ten number from 0 to 255. The default value is "0.0.0.0".

Example: The following sets a static Default Gateway.

```
SYST:COMM:LAN:GATE "168.012.000.001"
```

Setting the LAN Host Name The Host Name is the host portion of the domain name, which is translated into an IP address.

- If you change the Host Name, you must cycle power on the digitizer to activate the new setting.
- If DHCP is enabled (SYSTem:COMMunicate:LAN:DHCP ON), the DHCP server can assign a different name if the requested name is already in use on the network. However, if DHCP is disabled, the specified (static) Host Name will be used.
- The factory default DNS Address for the digitizer is A-L4532A-*nnnnn* or A-L4534A-*nnnnn*, where *nnnnn* is the last 5 digits in the digitizer's serial number.
- The Host Name is stored in non-volatile memory; it does not change when power has been off or after a Factory Reset (*RST command).

To set a static Host Name, use this command:

```
SYSTem:COMMunicate:LAN:GATEway "<address>"
```

<address> is a required parameter. You must specify a quoted string of up to 15 characters. The first character must be a letter (A-Z), but the remaining 14 characters can be letters, numbers (0-9), or dashes ("-"). Blank spaces are not allowed.

Example: The following sets a static Host Name.

```
SYST:COMM:LAN:HOST "LAB1-L4532A"
```

Setting the LAN IP Address An Internet Protocol (IP) address is required for all IP and TCP/IP communications with the digitizer.

If you plan to use a static IP address on a site LAN, contact your network administrator to obtain a fixed IP address to be used exclusively for your digitizer.

- If you change the IP Address, you must cycle power on the digitizer to activate the new setting.
- If DHCP is enabled (SYSTEM:COMMunicate:LAN:DHCP ON), the specified static IP address is not used. However, if the DHCP server fails to assign a valid IP address, or if DHCP and Auto-IP are both off, the currently configured static IP address will be used.
- The factory default IP Address for the digitizer is A-L4532A-*nnnnn* or A-L4534A-*nnnnn*, where *nnnnn* is the last 5 digits in the digitizer's serial number.
- The IP Address is stored in non-volatile memory; it does not change when power has been off or after a Factory Reset (*RST command).

To set a static IP Address, use this command:

```
SYSTEM:COMMunicate:LAN:IPAddress "<address>"
```

<address> is a required parameter. You must specify a quoted string in four-byte dot notation, where each of the four numbers is a base ten number from 0 to 255. The default value is "0.0.0.0".

Example: The following sets a static IP Address.

```
SYST:COMM:LAN:IPAD "255.255.149.34"
```

Setting the LAN Subnet Mask The digitizer uses the Subnet Mask to determine if a client IP address is on the same local subnet. When a client IP address is on a different subnet, all packets must be sent to the Default Gateway.

Contact your network administrator to determine whether subnetting is being used and for the correct Subnet Mask.

- If you change the Subnet Mask, you must cycle power on the digitizer to activate the new setting.
- If DHCP is enabled (SYSTem:COMMunicate:LAN:DHCP ON), the specified static Subnet Mask is not used. However, if DHCP is disabled, the currently configured static Subnet Mask will be used.
- The factory default Subnet Mask for the digitizer is "255.255.0.0". A value of "0.0.0.0" or "255.255.255.255" indicates that subnetting is not being used.
- The Subnet Mask is stored in non-volatile memory; it does not change when power has been off or after a Factory Reset (*RST command).

To set a static Subnet Mask, this command:

```
SYSTem:COMMunicate:LAN:SMASk "<address>"
```

<address> is a required parameter. You must specify a quoted string in four-byte dot notation, where each of the four numbers is a base ten number from 0 to 255. The default value is "255.255.0.0".

Example: The following sets a static Subnet Mask.

```
SYST:COMM:LAN:SMAS "255.255.0.0"
```

Querying the MAC Address The digitizer has a unique Media Access Control (MAC) address, also known as the link-layer address, the Ethernet (station) address, LANIC ID, or Hardware Address. This is an unchangeable 48-bit address assigned by the manufacturer to each unique Internet device.

Your network administrator may need the MAC address to assign a static IP address for this device.

The digitizer's MAC address is set at the factory and stored in non-volatile memory.

To obtain your digitizer's MAC Address, send this query:

```
SYSTem:COMMunicate:LAN:MAC?
```

Example: The following query returns the digitizer's MAC Address.

```
SYSTem:COMMunicate:LAN:MAC?
```

Typical response: "00-30-D3-00-10-41"

Setting the Telnet Command Prompt The Telnet Prompt is the command prompt seen when using a Telnet session to communicate with the digitizer. Use a Telnet session to transfer commands (using the Agilent digitizer command language) and read responses over a TCP/IP network.

- The digitizer uses LAN port 5024 for Telnet sessions and 5025 for Socket sessions.
- A Telnet session can typically be started as follows from a host computer shell. For example:

```
telnet 169.254.4.10 5024
```

- To exit a Telnet session, press <Ctrl-D>.
- The factory default Telnet Prompt for the digitizer is L4532A or L4534A.
- The Telnet Prompt is stored in non-volatile memory; it does not change when power has been off or after a Factory Reset (*RST command).

To specify the Telnet Prompt, use this command:

```
SYSTem:COMMunicate:LAN:TELNet:PROMpt "<string>"
```

<string> is a required parameter. You must specify a quoted string of up to 15 characters. The first character must be a letter (A-Z), but the remaining 14 characters can be letters, numbers (0-9), or dashes ("-"). Blank spaces are not allowed.

Example: The following sets the Telnet Prompt to COMMAND>.

```
SYST:COMM:LAN:TELN:PROM "COMMAND>"
```

Setting the Telnet Welcome Message The digitizer displays the Telnet Welcome Message when you use a Telnet session to communicate with the digitizer.

- The factory default Telnet Welcome Message for the digitizer is "Agilent L4532A Instrument" or "Agilent L4534A Instrument".
- The Telnet Welcome Message is stored in non-volatile memory; it does not change when power has been off or after a Factory Reset (*RST command).

To specify a Telnet Welcome Message, use this command:

```
SYSTem:COMMunicate:LAN:TELNet:WMESsage "<string>"
```

<string> is a required parameter. You must specify a quoted ASCII string of up to 63 characters.

Example: The following sets the Telnet Welcome Message to "Welcome to L4534A Telnet Session".

```
SYST:COMM:LAN:TELN:WMES "Welcome to L4534A Telnet  
Session"
```

LAN Configuration Changes and LAN Reset To update any LAN configuration changes you make, use this command:

```
SYSTem:COMMunicate:LAN:UPDate
```

This command disconnects all active LAN and Web Interface connections, updates any LAN changes you made, and restarts the LAN interface with the new settings. The IP address may change, depending on how your digitizer's IP address is assigned.

You must send this command in order for the changes you made using any of these commands take effect:

```
SYSTem:COMMunicate:LAN:DHCP  
SYSTem:COMMunicate:LAN:DNS  
SYSTem:COMMunicate:LAN:GATEWay  
SYSTem:COMMunicate:LAN:HOSTname  
SYSTem:COMMunicate:LAN:IPADdress  
SYSTem:COMMunicate:LAN:SMASk
```

If you update the digitizer with any invalid LAN settings, it may not work on the LAN. If it does not, push the rear panel **LAN reset** button to restore the settings to the default values listed on [page 198](#), or use another interface—such as USB—to correct the settings.

Communicating over the LAN

The *Agilent IO Libraries Suite* along with instrument drivers for specific programming environments can be used to communicate with your digitizer. You can also communicate with your digitizer using its built-in Web Interface, the Telnet utility, or sockets.

Telnet and sockets provide convenient ways to communicate with the digitizer without using I/O libraries or drivers.

Using Telnet

In an MS-DOS Command Prompt window, type: `telnet hostname 5024` where `hostname` is the digitizer's hostname or IP address, and 5024 is the digitizer's Telnet port.

You should get a Telnet session box with a title indicating that you are connected to the L4532A or L4534A. Type the remote commands at the prompt.

Using Sockets

Agilent instruments have standardized on using port 5025 for remote programming socket services. A data socket on this port can be used to send and receive commands, queries, and query responses. All commands must be terminated with a newline for the message to be parsed. All query responses will also be terminated with a newline.

The digitizer allows any combination of up to three simultaneous data socket and Telnet connections to be made.

The socket programming interface also allows a control socket connection. The control socket can be used by a client to send device clear and to receive service requests. Unlike the data socket, which uses a fixed port number, the port number for a control socket varies and must be obtained by sending the following query to the data socket:

```
SYSTem:COMMunicate:TCPip:CONTRol?
```

After the control port number is obtained, a control socket connection can be opened. As with the data socket, all commands to the control socket must be terminated with a newline, and all query responses returned on the control socket will be terminated with a newline.

To send a device clear, send the string "DCL" to the control socket. When the power system has finished performing the device clear it echoes the string "DCL" back to the control socket.

Service requests are enabled for control sockets using the Service Request Enable register. Once service requests have been enabled, the client program listens on the control connection. When SRQ goes true the digitizer will send the string "SRQ +nn" to the client. The "nn" is the status byte value, which the client can use to determine the source of the service request.



5 Understanding Key Concepts

This chapter provides a detailed introduction to the digitizer's operating states and control options. It presents all key configuration concepts and choices, so that you can understand the features you may choose to configure.

Digitizer Operating States 90

Operating States Diagram	91
The Stand-By State	92
The Idle State	92
The Calibrating State	93
The Self-Test State	94
The Acquisition State	95
The Wait for Arm State	96
The Armed State	97
The Wait For Trigger State	98
The Triggered State	99
The On-Board Measurement State	100
The Data Transfer State	101

Basic Configuration Concepts and Choices 102

Data Records	103
Sample Rate	106
Channel-Specific Parameters	108
Range and Resolution	108
Signal Coupling	109
Low-Pass Filter	109
Overvoltage Protection	110

Arming and Triggering Concepts and Choices 111

Selecting an Arming Source	111
Selecting a Triggering Source	114
Trigger Timing	120

Data Retrieval Concepts and Choices 127

Selecting a Data Retrieval Format	128
Selecting Which Command To Use for Returning Sample Data	135
Selecting Which Sample Data to Return	136
Understanding the Returned Data: Bytes, Blocks, and Lists	141



Digitizer Operating States

This section explains the primary digitizer *operating states*, describes which functions you may perform while the digitizer is in each state, and illustrates the commands, events, and actions which determine the current state. The next page provides a high-level diagram of all eleven states; subsequent pages provide a more detailed look at each. These states, in the order covered, are:

- **Stand-By** (the digitizer is connected to an AC power source but powered-down), described on [page 92](#).
- **Idle** (the digitizer is powered-up and ready to receive commands), described on [page 92](#).
- **Calibrating** (the digitizer is performing a calibration), described on [page 93](#).
- **Self-Test** (the digitizer is executing a self-test), described on [page 94](#).
- **Acquisition** (the digitizer is initiated and acquiring data), described on [page 95](#). This state encompasses four sub-states:
 - **Wait for Arm** (the digitizer is initiated and waiting for the trigger to be armed), described on [page 96](#).
 - **Armed** (an arm event has been recognized), described on [page 97](#).
 - **Wait for Trigger** (the digitizer is armed and waiting for a trigger), described on [page 98](#).
 - **Triggered** (a trigger event has been recognized), described on [page 99](#).
- **On-Board Measurement** (an on-board measurement is being evaluated), described on [page 100](#).
- **Data Retrieval** (data is being retrieved—or fetched—from sample memory), described on [page 101](#).

During the discussion of some digitizer operating states, *trigger timing* parameters are briefly introduced. These parameters, trigger holdoff and trigger delay, apply to the Acquisition state and its substates; they determine when the digitizer proceeds from the Armed state through the Wait for Trigger state to the Triggered state. A complete understanding of trigger timing—necessary for accurate control of a testing program involving high-speed transient signals—is covered in detail beginning on [page 120](#), in “Trigger Timing”.

Operating States Diagram

This high-level diagram introduces the basic relationships between the digitizer operating states. More complex paths exist to move between states, particularly in the Acquisition state; these will be discussed in detail in the following pages.

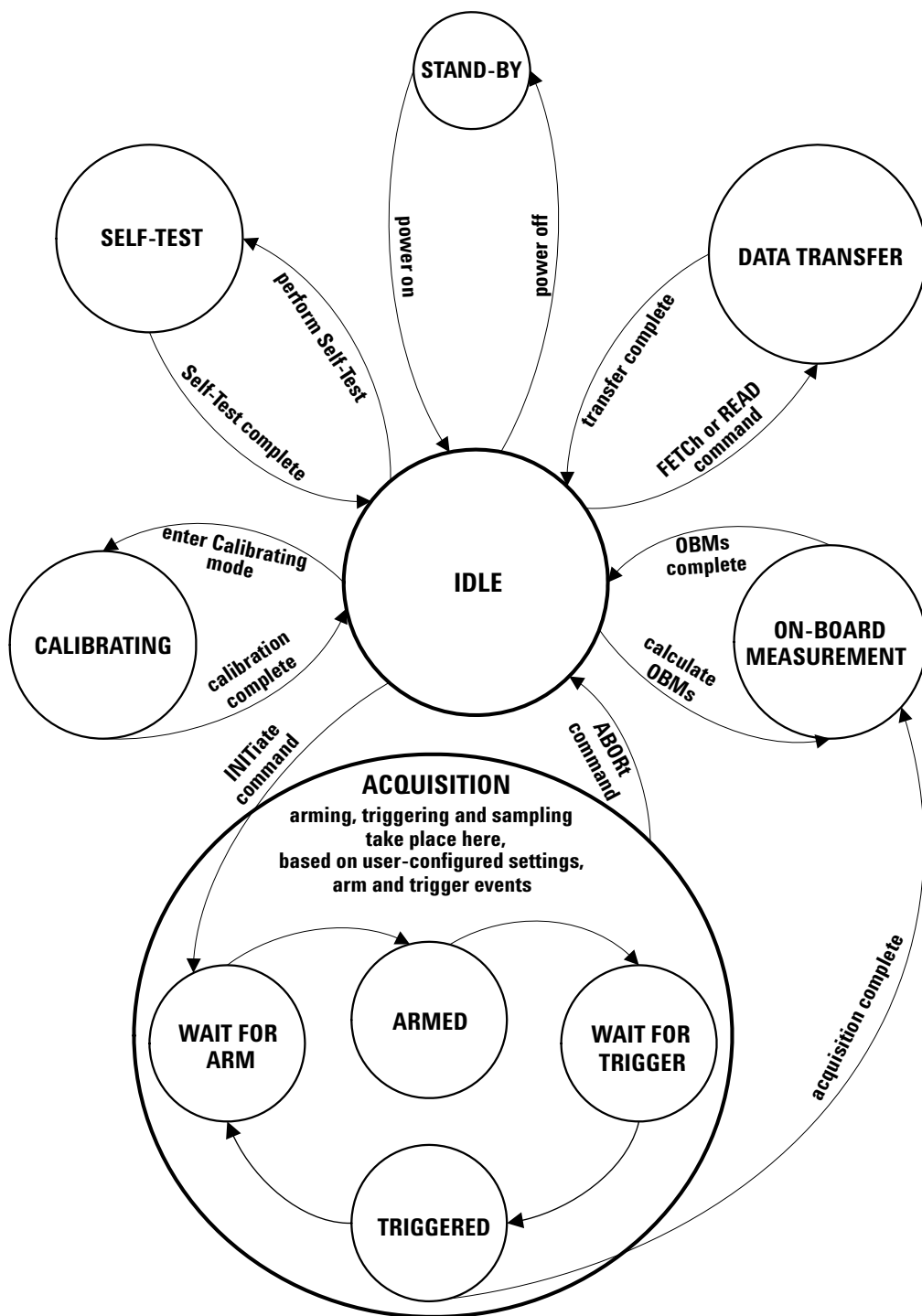

The Stand-By State

With power connected, the unit is in the **Stand-By** state. In stand-by mode, line power continues to drive the digitizer's internal power supply; however, no power is provided to its measurement circuitry and no commands are recognized.

Pressing the “on/stand-by” button (⏻) once starts the digitizer's power-on sequence (see “[Applying Power](#)” on page 18). When the power-on sequence completes, the digitizer enters the Idle state.

To return the digitizer to the Stand-By state, press the “on/stand-by” button (⏻).

The Idle State

The digitizer is in the **Idle** state at power-on, after the power-on sequence completes. It returns to the Idle state:

- Immediately if an `ABORT` or `*RST` command is issued.
- After the Calibration, Self-Test, Data Transfer, or On-Board Measurement processes complete.
- After acquisition completes (following `INITiate`, all configured records have been digitized) and all installed on-board measurements have been evaluated.

While in the Idle state, you can:

- Perform an Auto-Zero calibration.
- Enter the Calibration state.
- Perform a Self-Test.
- Update the digitizer's firmware.
- Retrieve readings from sample memory, if valid readings are available.
- Query measurements calculated from the sample data.
- Issue `SYSTEM` commands (for example: LAN configuration).
- Configure the digitizer.
- Initiate data acquisition.

While in the Idle state, the digitizer will ignore arm and trigger events.

To begin data acquisition from the Idle state, issue the `INITiate` command. `INITiate` will clear sample memory and put the digitizer in the Wait for Arm state.

The Calibrating State

The digitizer should be calibrated on a regular interval to ensure it meets its documented specifications. Complete instrument calibration procedures are covered in the *Agilent L4532A/34A Service Guide*.

From the Idle state, you can enter the **Calibrating** state by issuing this command sequence:

```
CALibration:SECure:STATE OFF
CALibration:STATE ON
```

While in the Calibrating state, most digitizer operation commands are not available (only a select set of CALibration commands are allowed) and will generate an error message if issued.

To return from the Calibrating state to the Idle state, issue this command sequence:

```
CALibration:STATE OFF
CALibration:SECure:STATE ON
```

From the Idle state, you can perform a quick Auto-Zero calibration –which also causes the digitizer to temporarily enter the Calibrating state–by issuing this command:

```
CALibration:ZERO:AUTO? (@<chan_list>)
```

The digitizer returns to the Idle state after the Auto-Zero calibration process is complete. See “[Auto-Zero Calibration](#)” on page 207 for a more complete description of this feature.

The diagram below shows the conditions which cause the digitizer to enter and exit the Calibrating state.

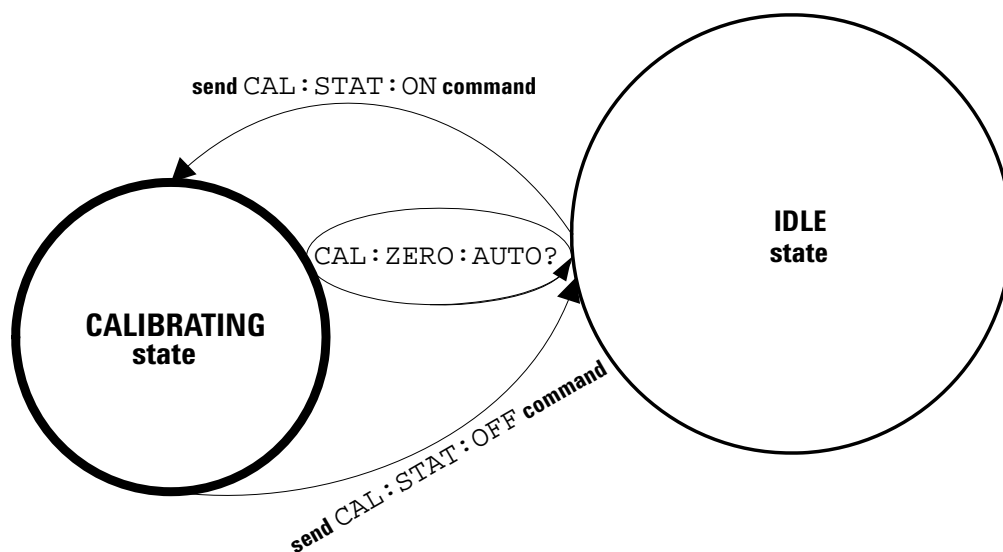

The Self-Test State

A brief power-on self-test occurs automatically whenever you cycle power to the digitizer. If the power-on self-test fails, you may wish to query the error conditions by issuing `SYSTEM:ERROR?`, and perhaps run a more complete Self Test; an automated procedure that systematically exercises the processor, digital infrastructure, memory, and analog front end subsystems. The Self-Test can be run from the Utilities tab of the Web Interface's Remote Control Page, or by issuing the `*TST` command.

From the Idle state, the digitizer enters the **Self-Test** state when you run the Self-Test, and returns to the Idle state after the Self-Test is complete. See “Self Test” on page 205 for a more complete description of this feature.

The diagram below shows the conditions which cause the digitizer to enter and exit the Self-Test state.

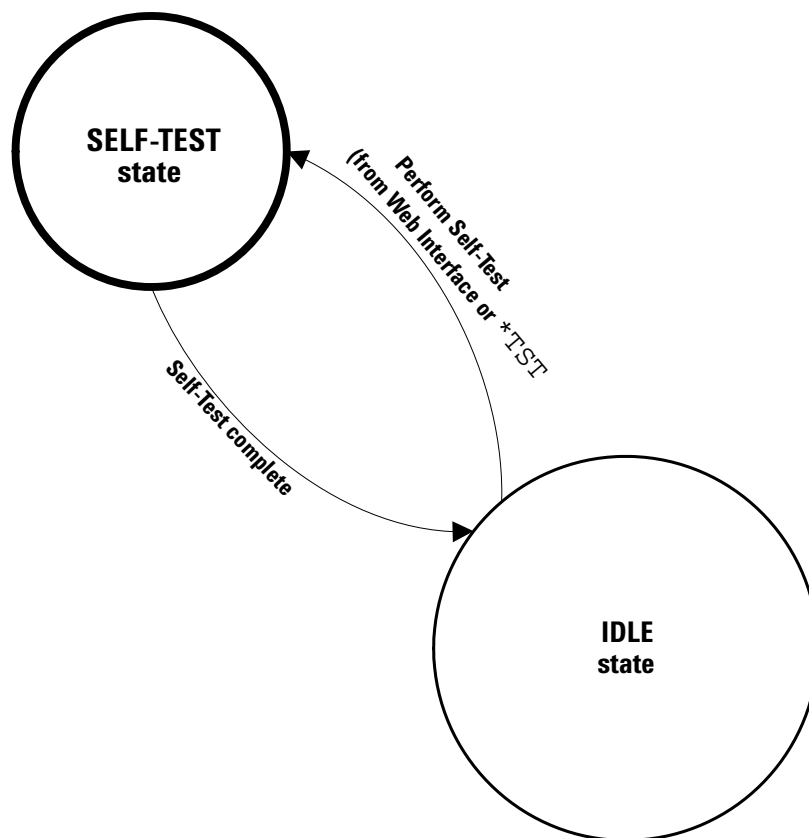

The Acquisition State

The digitizer must be initiated and armed before it can be triggered. While in the **Acquisition** state—where arming and triggering occur—the digitizer samples continuously at 20MSa/s, storing a decimated subset of both pre-trigger and post-trigger samples in sample memory.

From the Idle state, the digitizer enters the Acquisition state immediately after the `INITiate` command is issued.

While in the Acquisition state, the digitizer will pend any `INITiate` command it receives (that is, it will wait to process the command) until acquisition is completed and the digitizer returns to Idle.

The digitizer leaves the Acquisition state after the final configured record is written. The digitizer proceeds to the On-Board Measurement (OBM) state to evaluate any installed OBMs (if necessary) before returning to Idle.

Issuing an `ABORT` or device clear command will cause an immediate exit from the Acquisition state to the IDLE state.

The diagram below shows the conditions which cause the digitizer to enter and exit the Acquisition state.

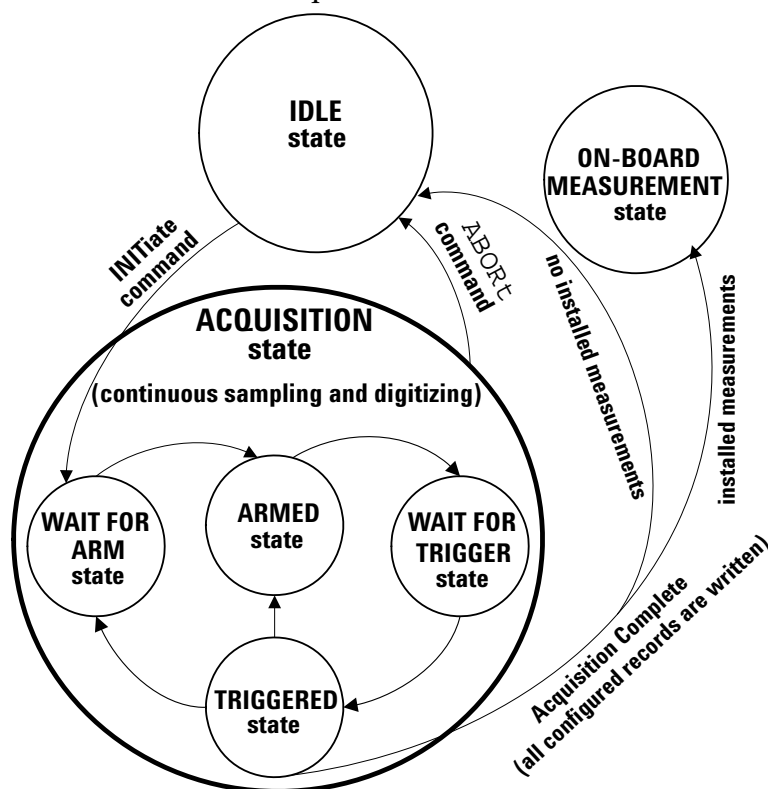

The Wait for Arm State

From the Idle state, the digitizer enters the **Wait for Arm** state and begins digitizing (collecting pre-trigger samples) immediately after the `INITiate` command has been issued.

Once in the Wait for Arm state, the digitizer proceeds to the Armed state when an *arm event* occurs. You can configure four types of arm events:

- If the command `[CONFigure:]ARM:SOURce IMMEDIATE` is issued, the digitizer is armed upon entering the Wait for Arm state (immediate arming).
- If `ARM[:IMMEDIATE]` is issued, the digitizer is armed once (software arming). `TRIGger[:IMMEDIATE]` also acts as an immediate arm event.
- If a user-configured external arming pulse is recognized, the digitizer is armed once (external arming).
- If the command `[CONFigure:]ARM:SOURce TIMEr` is issued, each time it enters the Wait for Arm state the digitizer will be armed after a user-configured time interval *<seconds>* elapses (timer arming).

The digitizer returns to the Wait for Arm state when all records configured for the previous arm event have been triggered and digitized, but the total configured number of records has not been reached.

Issuing an `ABORt` or device clear command will cause an immediate exit from the Wait for Arm state to the IDLE state.

The diagram below shows the conditions which cause the digitizer to enter and exit the Wait for Arm state.

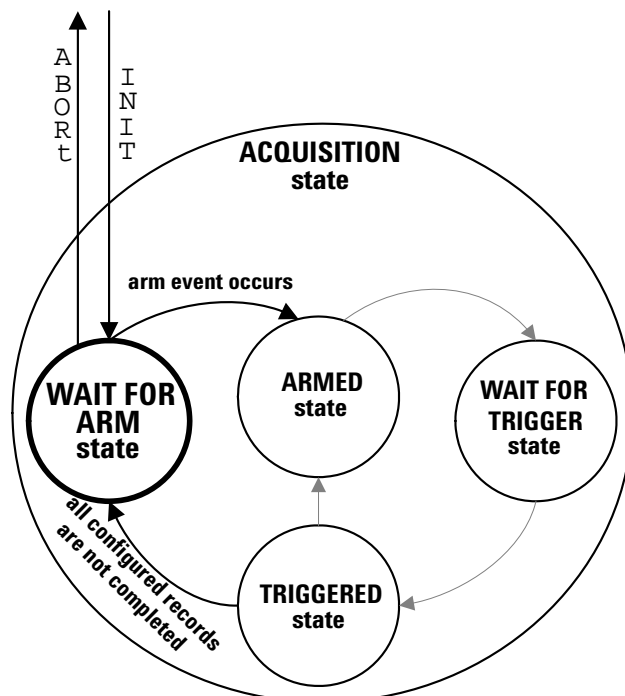

The Armed State

From the Wait for Arm state, the digitizer proceeds to the **Armed** state when an *arm event* occurs.

Once in the Armed state, the digitizer proceeds to the Wait for Trigger state after the user-configured number of pre-trigger samples have been stored and after the user-configured trigger holdoff period has elapsed.

The digitizer returns to the Armed state after the record configured for the previous trigger has been written and if more triggers are configured for the current arm event.

Issuing an `ABORT` or device clear command will cause an immediate exit from the Armed state to the IDLE state.

The diagram below shows the conditions which cause the digitizer to enter and exit the Armed state.

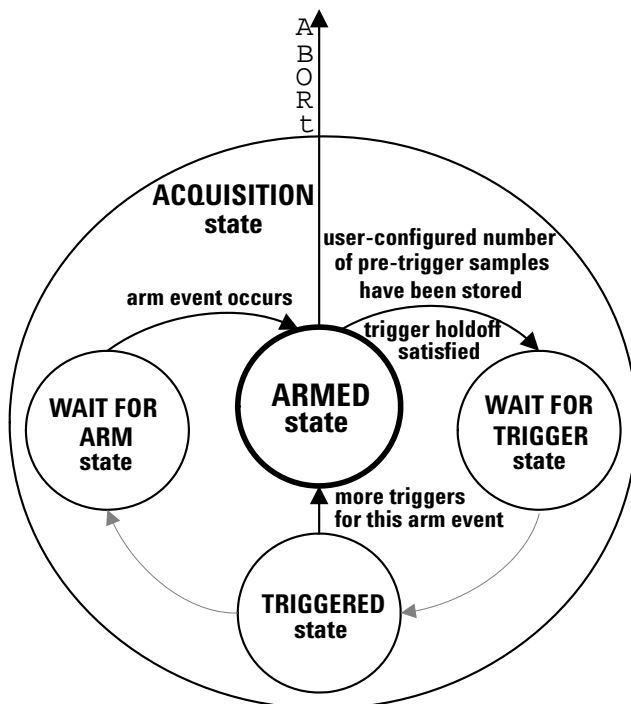

The Wait For Trigger State

From the Armed state, the digitizer proceeds to the **Wait for Trigger** state after the user-configured number of pre-trigger samples have been stored and after the user-configured trigger holdoff period has elapsed.

Once in the Wait for Trigger state, the digitizer will respond to a configured *trigger event*. After recognizing the trigger event, a user-defined trigger delay must elapse, then the digitizer will proceed to the Triggered state. You can configure five types of trigger events:

- If the trigger source is set to immediate (before INITiate), the digitizer is triggered automatically (immediate triggering), subject to the trigger delay and trigger holdoff.
- If TRIGger[:IMMediate], *TRG, or the IEEE 488.2 GET command is issued, the digitizer is triggered once, regardless of the configured trigger source (software triggering).
- For each user-configured external trigger source pulse that is recognized, the digitizer is triggered once (external triggering).
- For each user-configured channel trigger condition (a window event or edge event) that is recognized, the digitizer is triggered once (channel triggering).
- You can configure the digitizer to be triggered if either an external trigger or channel event is recognized (“or” triggering).

Issuing an ABORt or device clear command will cause an immediate exit from the Wait for Trigger state to the IDLE state.

The diagram below shows the conditions which cause the digitizer to enter and exit the Wait for Trigger state.

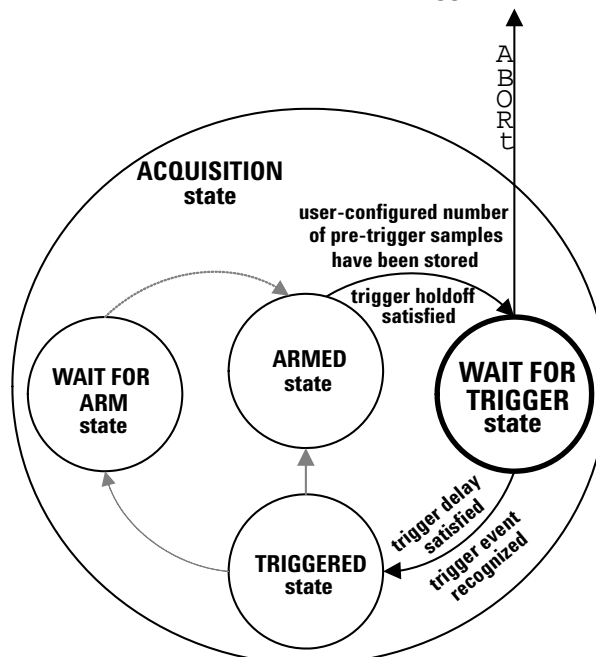

The Triggered State

From the Wait for Trigger state, the digitizer will look for a *trigger event*. After recognizing the trigger event, a user-defined trigger delay must elapse, then the digitizer will proceed to the **Triggered** state.

Once in the Triggered state, the digitizer will complete a record, by storing a user-configured number of post-trigger samples and a record preamble.

After completing that record:

- If more `<triggers_per_arm>` are configured for the current arm event using `[CONFIGure:]ARM:SOURce`, the digitizer will return to the Armed state.
- If the current arm event is completed but more records are configured using `[CONFIGure:]ACQuisition[:ATTRibutes]`, the digitizer will return to the Wait for Arm state.
- If acquisition is complete, the digitizer will store the acquisition preamble, and then proceed to the On-Board Measurement state to evaluate any installed measurements before returning to Idle.

Issuing an `ABORT` or device clear command will cause an immediate exit from the Triggered state to the IDLE state.

The diagram below shows the conditions which cause the digitizer to enter and exit the Triggered state.

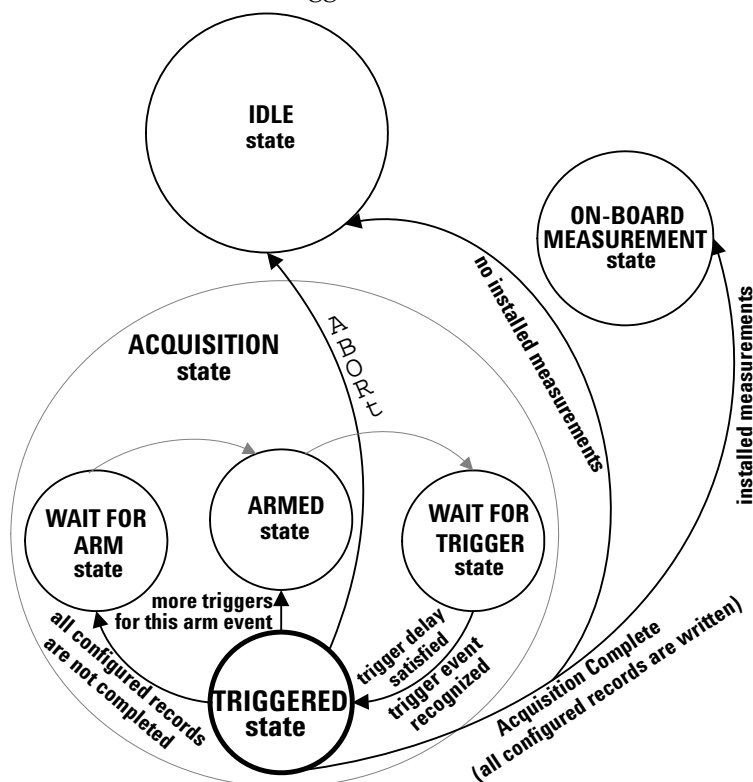

The On-Board Measurement State

From the Idle state, you can enter the **On-Board Measurement (OBM)** state by issuing any MEASure query (except for the MEASure:INSTall queries). The digitizer will evaluate and return the desired measurement results based on the data in sample memory, then return to Idle.

From the Triggered state, when acquisition is complete and if any measurements are installed (and the measurement window size is greater than zero, else no measurements will be evaluated); the digitizer will proceed to the OBM state to evaluate any installed measurements, then return to Idle. If no measurements are installed, the digitizer will proceed directly from the Triggered state to the Idle state.

While in the OBM state, the digitizer will pend any INITiate command it receives until the measurements are completed.

Issuing an ABORt or device clear command will cause an immediate exit from the OBM state to the IDLE state.

The diagram below shows the conditions which cause the digitizer to enter and exit the OBM state.

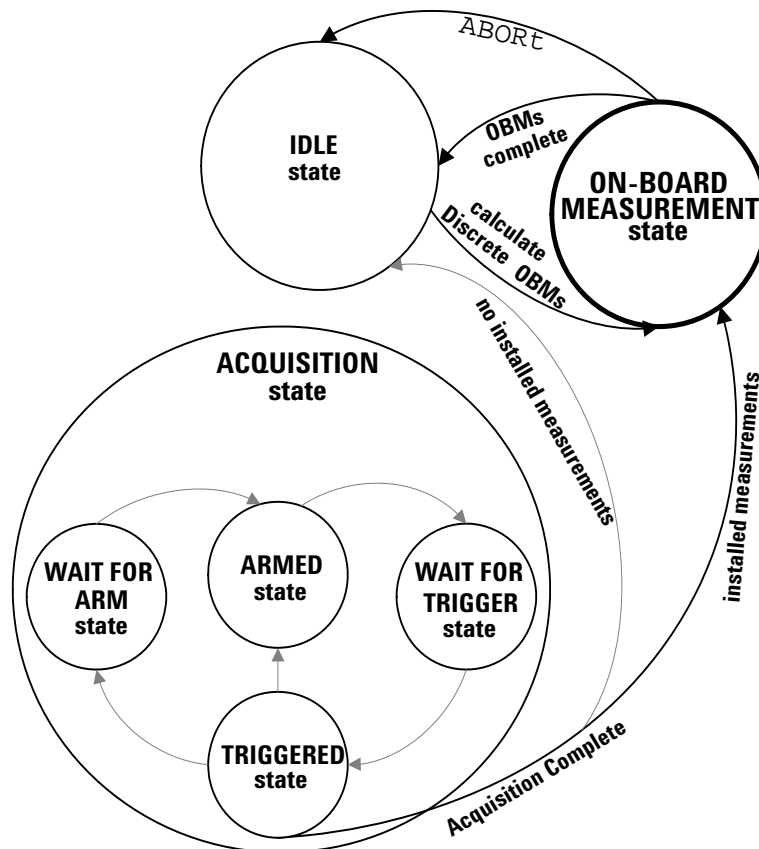

The Data Transfer State

From the Idle state, the digitizer enters the **Data Transfer** state when you issue one of the **FETCh** or **READ** queries (for example, **FETCh:WAVeform:ADC?**):

- The **FETCh** queries retrieve user-specified data already in sample memory from prior digitizing, then returns the digitizer to Idle.
- The **READ** queries first send an **INITiate** (clearing sample memory from prior digitizing), then proceed to digitize and retrieve user-specified data immediately after digitizing is complete.

Issuing an **ABORt** or device clear command will cause an immediate exit from the Data Transfer state to the **IDLE** state.

Whether a **FETCh** or **READ** query is issued, the data transfer effectively takes place from the Idle state as shown below.

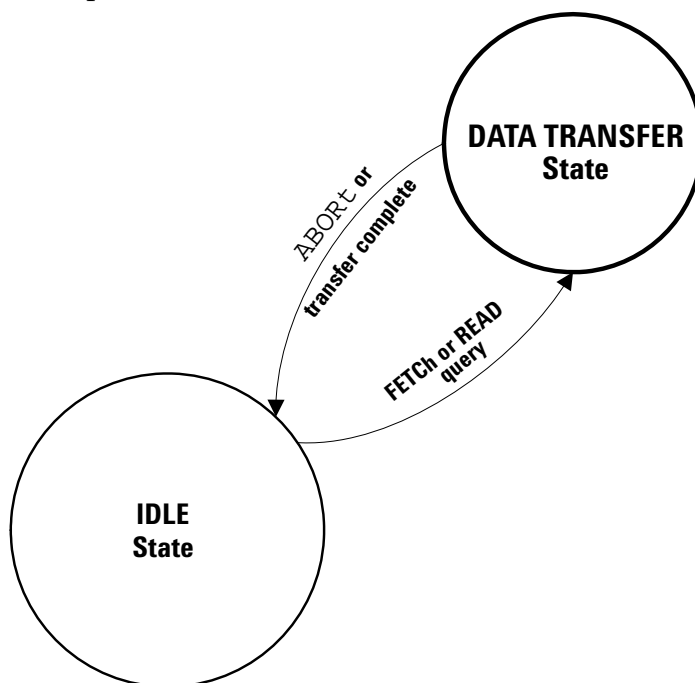

Basic Configuration Concepts and Choices

This section presents three sets of concepts key to configuring the digitizer: data records, sample rates, and channel-specific parameters.

The first subsection introduces the concept of a data record. It is important to understand how each trigger causes the digitizer to store a record of samples, including preamble (summary) data about the samples acquired. Each acquisition beginning with `INITiate` causes the digitizer to store an acquisition preamble and information about acquisition errors. This subsection introduces the stored record and preamble data. Your configuration of arm and trigger events influences the records captured per acquisition, so this subsection also introduces the number of triggers per arm event and the number of records per acquisition. “Data Records” begins on [page 103](#).

The second subsection introduces the concept of sample rate. While the digitizer always samples at its 20MSa/s hardware rate, your choice of sample rate dictates how frequently samples are stored, how many seconds of data can be acquired in sample memory and how completely you can capture your input waveform. “Sample Rate” begins on [page 106](#).

The third subsection introduces four channel-specific configuration parameters. Your choice of voltage range will depend on the expected characteristics of your input signal, and influences sampling resolution. You may select ac or dc signal coupling and one of three low pass filters as appropriate for your input signal. Finally, you can turn control the channel overvoltage protection relay feature. “Channel-Specific Parameters” begins on [page 108](#).

Data Records

The L4532A/34A digitizers store digitized samples in records. Each trigger results in one saved record. An *acquisition* consists of a configured number of records you will acquire after an `INITiate` command, before returning to Idle (and subsequently retrieving data).

A Typical Data Record

A data *record* is an abstract, as you query its attributes using several commands. You may retrieve sample data from each record, a preamble for each record, a preamble for the entire acquisition (may include one or more records), or a set of all record timestamps for an acquisition.

However, you should be familiar with what the digitizer stores each time it is triggered; we will call this a record and provide a graphic representation of one for purposes of understanding the stored data:

The Record Preamble: Each record includes a *record preamble*, with seven elements:

- The record number.
- The sample count completed.
- The number of pre-trigger samples in the record.
- The *trigger timestamp*. This is the elapsed time from when the timestamp counter was zeroed to when this record's trigger occurred.
- The *trigger timestamp latency*. This is the elapsed time since the trigger occurred (and any user-configured trigger delay transpired) to when the record's first post-trigger sample (sample 0) was taken.
- The *sample count completed*. This is the total number of samples (pre-trigger and post-trigger) actually stored in the record. An `ABORT` command can cause the number of samples stored in the final record to be less than in the previous records.
- A *channels with error* code. The error code is a bit sum, which reveals if an acquisition error occurred on each channel for the subject record.

The record includes the preamble and a buffer holding the latest digitized samples, as shown figuratively below:

Data Record							
Record Preamble						Record Number	Circular Buffer (digitized samples)
Record Number	Sample Count Completed	# of Pre-trig Samples	Trigger Timestamp	Timestamp Latency	Channels with Error		

The Data Record: After the header, each record includes a *circular buffer* which contains the digitized samples specified for the record’s acquisition. The digitizer begins to fill this buffer once in the Acquisition state, and keeps the latest samples in the buffer when acquisition completes. The timestamp indicates sample 0, therefore it indicates which samples in the buffer are pre-trigger versus post-trigger samples. The graphic below shows pre-trigger samples numbered from $-t$ to -1 , and post-trigger samples numbered from 0 to $+tt$.

Circular Buffer (digitized samples)																													
Pre-Trigger Samples												Post-Trigger Samples																	
sample $-t$				sample -2				sample -1				sample 0				sample 1				sample tt									
S- t Ch1	S- t Ch2	S- t Ch3	S- t Ch4	•	•	•	S-2 Ch1	S-2 Ch2	S-2 Ch3	S-2 Ch4	S-1 Ch1	S-1 Ch2	S-1 Ch3	S-1 Ch4	S0 Ch1	S0 Ch2	S0 Ch3	S0 Ch4	S1 Ch1	S1 Ch2	S1 Ch3	S1 Ch4	•	•	•	S tt Ch1	S tt Ch2	S tt Ch3	S tt Ch4

The Acquisition Preamble: Each acquisition begins with INITiate and ends when all configured records have been digitized or with an aborted acquisition. In addition to storing the individual records shown on [page 103](#), the digitizer also stores an acquisition preamble, and stores an error code for each record acquired on each channel.

The *acquisition preamble* includes seven elements:

- The number of the last record completed.
- The last record’s sample count completed. An ABORT command can cause this number to be less than in the previous records.
- The total sample count completed for all records in the acquisition.
- The *completion status*. This represents how the acquisition completed (normal or aborted acquisition, still running, or no data).
- The number of the first record with an acquisition error, if any.
- A *channels with error* code. The error code is a bit sum, which reveals if an acquisition error occurred on each channel during the acquisition (may include one or more records).
- *INIT Timestamp*. This is the timestamp (in seconds) of the INITiate command.

The acquisition preamble record includes the preamble and a buffer holding the latest digitized samples, as shown figuratively below:

Acquisition Preamble						
Last Record Completed	Last Record’s Sample Count Completed	Total Acquisition Sample Count Completed	Completion Status	First Record w/Error	Channels with Error	INIT Timestamp

Selecting the Number of Records, Arm and Trigger Events Per Acquisition

Two configuration commands determine the number of records per acquisition and how many arm and trigger events create those records:

- The [CONFigure:]ACQquisition[:ATTRibutes] command (or its short form [CONFigure:]ACQquisition:RECOords) allows you to select the total number of records *<num_records>* in a given acquisition (the default is 1).
- The [CONFigure:]ARM:SOURce command allows you to select the total number of triggers *<triggers_per_arm>* gated by each arm event (the default is 1024).

At most, you can specify that the digitizer accepts 1024 triggers and creates 1024 records with one arm event:

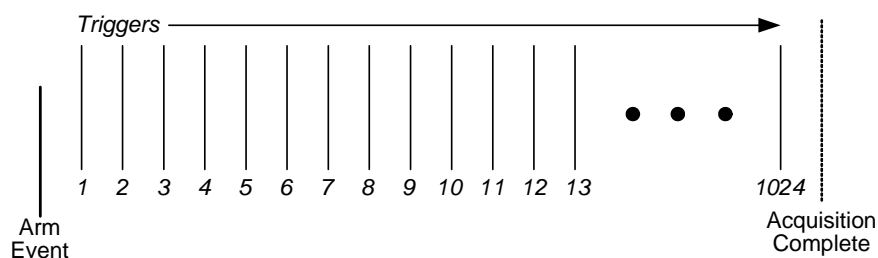

If you set *<num_records>* to 12 and *<triggers_per_arm>* to 2, an acquisition creates 12 records with six arm events:

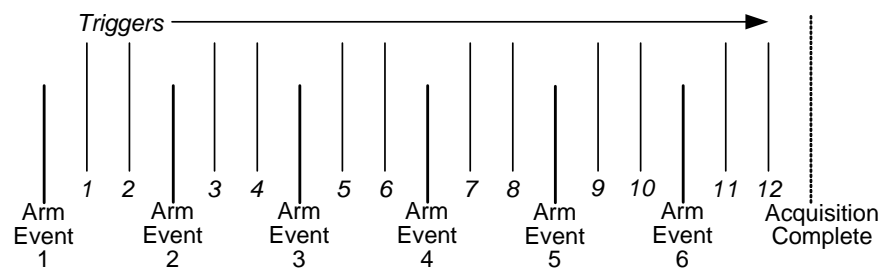

If you set *<num_records>* to 35 and *<triggers_per_arm>* to 10, the acquisition creates 35 records with four arm events, and returns to the Idle state rather than return to the Wait for Arm state a fifth time.:

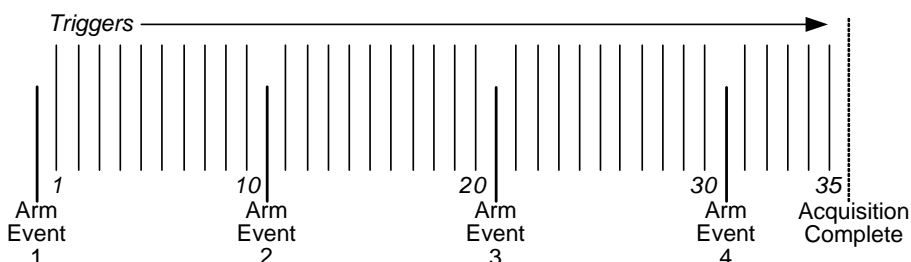

Sample Rate

The L4532A/34A samples at a fixed internal rate of 20 MSa/s regardless of configuration. For high-speed transient signal measurement, you may well need the full speed of the digitizer. However, for many applications you may optimize data throughput (reduce the amount of sample data stored) or extend the available sampling period by selecting a lower sample rate.

Sample Rate Choices

The digitizer provides fourteen choices of sample rate, which apply to all digitizer channels. You can set the sample rate with the `<sample_rate>` parameter of either of these commands:

```
[CONFigure:]ACQuisition[:ATTRibutes] (sets many attributes)
[CONFigure:]ACQuisition:SRATE (sets sample rate only)
```

The supported choices for `<sample_rate>` (all represent values in samples per second) are:

```
1000
2000
5000
10000
20000
50000
100000
200000
500000
1000000
2000000
5000000
10000000
20000000 (default)
```

The `<sample_rate>` is actually a numeric—not discrete—parameter, and you can enter any integer value up to 20000000 without generating an error. The digitizer will coerce your entry up to the nearest supported choice if you do not select one of the supported choices.

Implications of Your Sample Rate Selection

Configuring a sample rate lower than 20 MSa/s causes the digitizer to *decimate* the data (store only a subset of the captured samples in sample memory):

- At `<sample_rate> = 1000 Sa/s`, the digitizer stores one sample from every 20,000 digitized samples.
- At `<sample_rate> = 10 MSa/s`, the digitizer stores every other digitized sample.

All fetches from memory are made from this stored, decimated data.

Knowing how many samples are saved (based on the sample rate) lets you calculate how many seconds of signal data per channel you can acquire with the digitizer's available sample memory capacity. For instance, at 10 MSa/s, you can acquire

- 3.2 seconds of data using the standard (32 MSa) memory option, or
- 12.8 seconds of data using the deep (128 MSa) memory option.

From the acquired data, you can selectively query (using FETCh or READ) for a decimated set of data out of the stored samples in memory, on a per-channel basis. This allows you to improve data retrieval speed, if one or more channels does not require the set sampling rate, by

Minimum Suggested Sample Rate

The input signal you plan to digitize may be a steady state or cyclic waveform, a pulse or pulse train, a single transient, or a complex mix of signal components.

For most transient electrical signal measurements, the specific signal behavior you need to characterize will determine sample rate. You can use the graphical display in the Web Interface as a guide to determine the optimum minimum sampling rate. When in doubt, sample at the highest rate which can capture the entire duration of the signal event. You can always subsequently reduce the data fetched from the data stored, using FETCh or READ.

To avoid aliasing errors, your sampling rate must exceed the Nyquist rate. The Nyquist rate is twice the highest frequency component contained within the input signal. In practice, Agilent recommends that for best accuracy, you select a sampling rate well in excess of the Nyquist rate, five to ten times that of the highest frequency component you anticipate in your input waveform.

Channel-Specific Parameters

You may configure four parameters specific to an individual input channel or channel list:

- Input Voltage Range (see “Range and Resolution” on page 108).
- AC or DC Signal Coupling (see “Signal Coupling” on page 109).
- Low-Pass Digital Input Filter (see “Low-Pass Filter” on page 109).
- Input Overvoltage Protection (see “Overvoltage Protection” on page 110). *This is an infrequently used feature; it is grouped here because it is a channel-specific setting.*

Range and Resolution

The digitizer’s floating inputs have a maximum voltage range of ± 256 V (rated for up to ± 250 V input signals), and will digitize input signals with 16-bit resolution. For high-voltage applications, you may well need the maximum voltage range of the digitizer. For best accuracy, select the lowest voltage range that will not result in over-range samples

How To Specify: The digitizer provides eleven choices of voltage range, which you can specify individually for any digitizer channel(s). Set the voltage range with the `<range>` parameter of either of these commands:

```
[CONFigure:]CHANnel[:ATTRibutes] (sets many attributes)
[CONFigure:]CHANnel:RANGE (sets <range> only)
```

The choices for `<range>` (all represent voltage ranges in \pm Volts) are:

```
0.25
0.5
1
2
4
8
16
32
64
128
256 (default)
```

The 16 bits of resolution result in 65,535 discrete analog-to-digital converter (ADC) codes representing 32,767 positive, 32,767 negative and zero voltage levels. Therefore, at the maximum voltage range of 256 V the sampled waveforms are resolvable down to approximately 0.0078 V (256 V/32767 discrete levels).

Selecting a smaller voltage range will allow the digitizer to resolve smaller discrete levels for each sample. At the lowest voltage range setting of 0.25 V, the digitizer can resolve approximately 0.0000076 V.

Signal Coupling

The digitizer's input channels can be configured for AC or DC coupling. DC coupling (the default) allows all DC and low-frequency components of a signal to pass. AC coupling removes any DC offset from the input signal and attenuates any low frequency components.

Use When: Specify AC coupling when you wish to accurately sample an AC signal with a DC offset.

How To Specify: Select AC or DC coupling for the specified channel(s) with the *<coupling>* parameter of either of these commands:

```
[CONFigure:]CHANnel[:ATTRibutes] (sets many attributes)
[CONFigure:]CHANnel:COUPling (sets <coupling> only)
```

Example: The following command selects AC coupling for channel 1.

```
CONF:CHAN:COUP (@1), AC
```

Low-Pass Filter

The digitizer's input channels pass all signals below 20 MHz by default. Two other low-pass filter settings are available: 2 MHz and 20 kHz. The digitizer employs a two-pole Bessel filter.

Use When: Specify one of the non-default filter settings when you are measuring low-frequency signals and wish to reduce the presence of high-frequency noise or harmonics.

How To Specify: Select the desired low-pass filter setting for the specified channel(s) with the *<filter>* parameter of either of these commands:

```
[CONFigure:]CHANnel[:ATTRibutes] (sets many attributes)
[CONFigure:]CHANnel:FILTer (sets <filter> only)
```

Example: The following command selects a 200 kHz low-pass filter for channel 3.

```
CONF:CHAN:FILT (@3), LP_200_KHZ
```

Overvoltage Protection

This feature applies only to digitizer operation using channel ranges of ± 2 V or less. Channels configured for ± 4 V or more never engage the overvoltage protection relay.

The digitizer's channel overvoltage protection feature automatically turns the input protection relay ON in the event of an overvoltage condition (typically between 11 and 14 V) on one or more of the input channels. This disconnects the channel's BNC connector from the measurement hardware. All samples taken on that channel with the protection relay ON (after the overvoltage condition is detected) will be stored as an overload (-32768 ADC code or 9.91E37 floating point code).

Before resuming digitizing on that channel, you must first identify and clear the cause of the overvoltage, then return the appropriate channel(s)'s input protection relay setting to OFF (default). This reconnects the channel's BNC connector from the measurement hardware; normal sampling operation from that channel is in effect.

Use When: You may choose to manually turn a channel's input protection relay ON to disconnect a channel, if you anticipate a signal source connected to that channel's BNC connector creating a voltage greater than its configured range.

How To Specify: Turn the input protection relay on or off for the specified channel(s) with the `<mode>` parameter of this command:

```
[CONFIgure:]CHANnel:PROTection[:RELay]
```

Example: The following command turns the input protection relays off for all channels, readying the inputs for normal sampling operation.

```
CHAN:ATTR:PROT (@1:4),OFF
```

Example: The following command turns the input protection relay on for channel 3, in anticipation of a +300V signal during testing.

```
CHAN:ATTR:PROT (@3),ON
```

If an Overvoltage Event or Protection On Event Occurs During Acquisition: The digitizer will store the following helpful information:

- Sample values of $\times 800H$ (in ADC16 format) will be stored instead of actual voltages. You would see these values if you fetch the affected acquisition data.
- Appropriate error bits will be stored to indicate all overvoltage errors, by channel and record where they occurred. You can query these errors using `FETCH:WAVEform:CHANnel:ERRor?`
- The questionable data register will store an appropriate bit to indicate that an overvoltage occurred. You can query this register using `STATus:QUESTionable [:EVENT]?`

Arming and Triggering Concepts and Choices

This section describes the options for arming and triggering the digitizer, to enable you to choose the options best suited for your test application before proceeding to configuration.

Selecting an Arming Source

From the Wait for Arm state, the arm event you specify using the [CONFIgure:]ARM:SOURce command must be recognized to arm the digitizer. Once armed, the digitizer will respond to a trigger event after the required number of pre-trigger samples have been taken and the trigger holdoff has elapsed.

You have four arming options; each defines an arm event:

- Immediate arming
- Software arming
- External arming
- Timed arming

These options are presented in detail in the following subsections.

Immediate Arming

Immediate arming is the default arm source setting. When configured, the digitizer performs like simpler digitizers without an arming feature; it is automatically armed (it passes through the Wait for Arm state) after INITiate. Rearming is automatic for subsequent triggers.

Use When: Use immediate arming when you need the digitizer to be armed and ready to respond to a configured trigger event.

How To Specify: Configure immediate arming by issuing the [CONFIgure:]ARM:SOURce IMMEDIATE command.

Any of the following commands will also force an immediate arm event, even when the [CONFIgure:]ARM:SOURce command is set to a different source than IMMEDIATE:

```
ARM[:IMMEDIATE]
TRIGGER[:IMMEDIATE]
*TRG
```

Example: The following command will automatically arm the digitizer.

```
CONF:ARM:SOUR IMM
```

Software Arming

When software arming is configured, after `INITiate` the digitizer is armed once when it receives any of the following commands (the latter two commands force an implicit arm event):

```
ARM[:IMMEDIATE]
TRIGGER[:IMMEDIATE]
*TRG
```

Use When: Use software arming when you want to arm the digitizer strictly under software control from your host application.

How To Specify: Configure software arming by issuing the `[CONFIGure:]ARM:SOURce SOFTware` command.

Example: The following command sequence configures the digitizer for software arming, then initiates and arms the digitizer.

```
CONF:ARM:SOUR SOFT
INIT
ARM
```

External Arming

When external arming is configured, after `INITiate` the digitizer is armed once when it recognizes a pulse to the rear panel **Trig In/Out** connector. The pulse must satisfy the `<slope>` parameter you set with the `[CONFIGure:]EXTErnal:INPut` command. The maximum allowable pulse voltage, minimum detectable pulse width and duty cycle are listed in “[Input Pulses](#)” on page 154.

Use When: Use external arming when you want to arm the digitizer strictly under hardware control. This is particularly useful when arming multiple digitizers simultaneously using a synchronous hardware mechanism.

How to Specify: Configure external arming by issuing the `[CONFIGure:]ARM:SOURce EXTErnal` command.

Example: The following command sequence configures the digitizer for immediate arming, initiates and arms the digitizer.

```
CONF:ARM:SOUR EXT
INIT
send arming pulse to the rear panel Trig In/Out connector
```

Timed Arming

When timed arming is configured, after INITiate the digitizer will experience a series of arms. Each arm will occur a time *<seconds>* after the previous record is completed and the digitizer returns to the Wait for Arm state.

Use When: Use timed arming when you want to pace the gating of a series of records a set duration apart.

How To Specify: Configure timed arming by issuing the [CONFigure:]ARM:SOURce TIMer command.

Set the arm delay time *<seconds>* up to 3600 s in 50ns increments, by issuing the [CONFigure:]ARM:SOURce:TIMer *<seconds>* command.

Allow for the time required to digitize all records from each arm's configured trigger(s), before setting the arm timer. See “[Trigger Timing](#)”, beginning on [page 120](#), to understand arm and trigger timing considerations.

Example: The following command sequence configures the digitizer for timed arming, initiates and arms the digitizer. The arm timer will count down two seconds (then arm the digitizer) each time the digitizer enters the Wait for Arm state.

```
CONF:ARM:SOUR:TIM 2.00
CONF:ARM:SOUR TIM
INIT
```

Selecting a Triggering Source

From the Wait for Trigger state, the trigger event you specify using the `CONFigure:TRIGger:SOURce` command must take place to trigger the digitizer. When the digitizer recognizes the trigger, it will proceed to the Triggering state after the trigger delay is satisfied. This conditions applies to all triggering options.

You have five triggering options; each defines a trigger event:

- Immediate triggering, the default trigger mode (see [page 114](#))
- Software triggering (see [page 115](#))
- External triggering (see [page 115](#))
- Channel edge triggering (see [page 116](#))
- Channel window triggering (see [page 114](#))
- “Or” triggering (see [page 114](#))

These options are presented in detail in the following subsections.

Immediate Triggering

Immediate triggering—the default trigger source setting—creates a trigger event equivalent to an automatic trigger. When configured, upon entering the Wait for Trigger state the digitizer will be automatically triggered, until the configured number of triggers per arm event is met.

Use When: Use immediate triggering when you do not need any trigger control; you just need to automatically trigger and immediately proceed with post-trigger digitizing.

How to Specify: Configure immediate triggering by issuing the `[CONFigure:]TRIGger:SOURce IMMEDIATE` command.

Note: Either of the following commands will also force an immediate trigger event, even when the `[CONFigure:]TRIGger:SOURce` command is set to a different source than `IMMEDIATE`:

```
TRIGger[:IMMEDIATE]
*TRG
```

Example: The following command sequence configures the digitizer for immediate arming and triggering and initiates the digitizer; triggering begins immediately after pre-trigger samples are taken and the trigger delay and holdoff are met.

```
CONF:ARM:SOUR IMM
CONF:TRIG:SOUR IMM
INIT
```

Software Triggering

When software triggering is configured, the digitizer is triggered once when it receives any of the following commands (all force an implicit arm event):

```
TRIGger[:IMMediate]
*TRG
the IEEE-488.2 GET command via a USB connection or VXI-11 session
```

Use When: Use software triggering when you want to trigger the digitizer strictly under software control from your host application.

How To Specify: Configure software triggering by issuing the [CONFigure:]TRIGger:SOURce SOFTware command, but any of the three software trigger commands listed above will force a trigger even if the trigger <source> is configured to a value other than SOFTware.

Example: The following command sequence configures the digitizer for software triggering, then initiates, arms and triggers the digitizer.

```
CONF:ARM:TRIG SOFT
INIT
TRIG:IMM
```

External Triggering

When external triggering is configured, from the Wait for Trigger state the digitizer is triggered once when it receives a pulse to the rear panel **Trig In/Out** connector. The pulse must satisfy the <slope> parameter you set with the [CONFigure:]EXTErnal:INPut command.

The maximum allowable pulse voltage, minimum detectable pulse width and duty cycle are listed in “[Input Pulses](#)” on page 154.

Use When: Use external triggering when you want to trigger the digitizer by applying an externally sourced trigger pulse.

How To Specify: Configure external triggering by issuing the [CONFigure:]TRIGger:SOURce EXTErnal command.

Example: The following command sequence configures the digitizer for immediate arming, sets the trigger source to external, initiates the digitizer, and sends a trigger.

```
CONF:ARM:SOUR IMM
CONF:TRIG:SOUR EXT
INIT
send a trigger pulse to the rear panel Trig In/Out connector
```

Channel Edge Triggering

When rising (positive) slope edge triggering is configured, from the Wait for Trigger state the digitizer is triggered once when any channel signal rises above its configured *<level>*. When falling (negative) slope edge triggering is configured, the digitizer is triggered once when a channel signal falls below the configured *<level>*. In both cases, you can configure a *<hysteresis>* level to avoid triggering on signal noise.

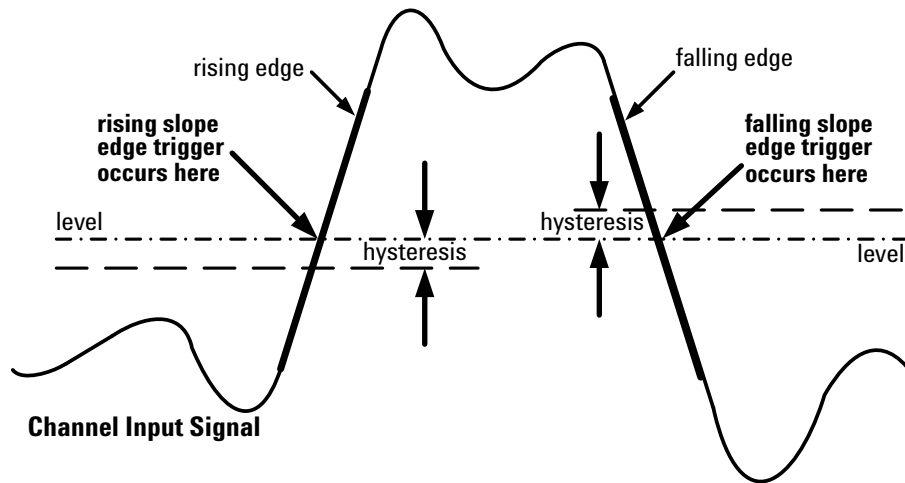

Use When: Use edge triggering when you want a signal transition (through a defined level of an applied input signal, on one or more specified channel(s)) to trigger the digitizer. An example of rising edge triggering is when you wish to capture a voltage spike on channel 1; you would trigger on the rising edge of the channel 1 signal.

How to Specify: Issue these two commands to configure edge triggering (the second command implicitly de-selects window triggering):

```
[CONFigure:]TRIGger:SOURce CHANnel
[CONFigure:]TRIGger:SOURce CHANnel:EDGE
```

Example: The following command sequence:

- Configures the range for channel 2 to be 16V
- Configures the digitizer for immediate arming.
- Selects channel triggering.
- Selects the edge trigger mode.
- Sets up the edge trigger for Channels 1 and 2, positive slope, level 10V, and 2 percent hysteresis (0.32V on a 256V scale).
- Sends a trigger when either Channel 1's or Channel 2's signal crosses 10V while rising (moving in a positive-going direction), after dropping below the hysteresis level of 9.68 V at least once.

```
CONF:CHAN:RANG 256
CONF:ARM:SOUR IMM
CONF:TRIG:SOUR CHAN
CONF:TRIG:SOUR:CHAN:EDGE (@1:2),10,POS,2
channel 2 drops below 10 V while in the Wait for Trigger state
```



Window Triggering

When window triggering is configured, from the Wait for Trigger state the digitizer is triggered once when a channel signal enters or leaves a configured window bounded by `<level_low>` and `<level_high>`. You can specify the window boundaries, the `<direction>` (ENTERing or LEAVing the window), and can configure a `<hysteresis>` level to avoid triggering on signal noise.

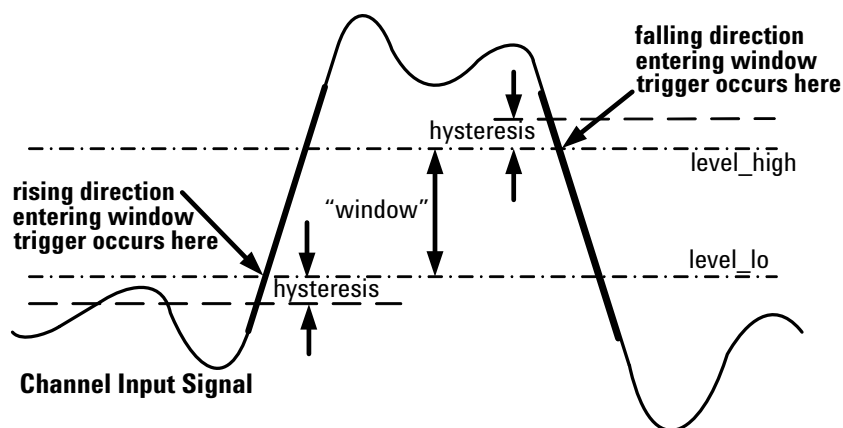
The diagram below illustrates, for entering window triggers, the relationships between the trigger points and configured direction, level_high, level_low, and hysteresis:

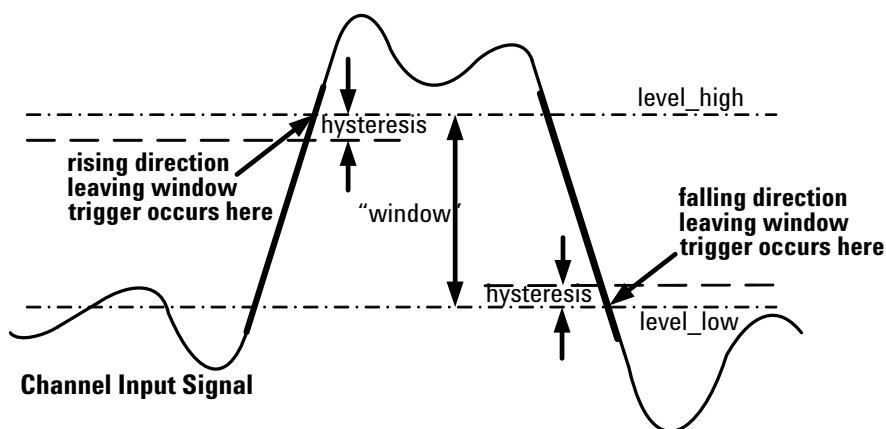

The diagram below illustrates, for leaving window triggers, the relationships between the trigger points and configured direction, level_high, level_low, and hysteresis:



Once a trigger event has occurred, the signal must pass through the hysteresis level before a subsequent trigger will be recognized.

Use When: Use window triggering when you want the applied input signal to trigger the digitizer when it is either entering or leaving a bounded voltage area. An example of a leaving window trigger would be to trigger measurement of an applied load which causes a regulated power supply output to stray outside its design range.

How to Specify: Issue these two commands to configure window triggering (the second command implicitly de-selects edge triggering):

```
[CONFigure:]TRIGger:SOURce CHANnel  
[CONFigure:]TRIGger:SOURce CHANnel:WINDow
```

Example: The following command sequence:

- Configures the range for channel 2 to be 16V
- Configures the digitizer for immediate arming.
- Selects channel triggering.
- Selects the window trigger mode.
- Sets up the window trigger for Channel 2, leaving the window, low level 9.5 V, high level 14.5 V, and 0.0 percent hysteresis.
- Sends a trigger when Channel 2's signal rises above 14.5V, for a regulated 12 V power supply with a design window of 9.5 V to 14.5 V.

```
CONF:CHAN:RANG 16  
CONF:ARM:SOUR IMM  
CONF:TRIG:SOUR CHAN  
CONF:TRIG:SOUR:CHAN:WIND (@2),9.5,14.5,LEAV,0  
channel 2 rises above 14.5V
```

“OR” Triggering

When OR triggering is configured, from the Wait for Trigger state the digitizer is triggered once when the digitizer recognizes either a configured external trigger event *or* a configured channel trigger event.

If the recognized trigger event is an external trigger, the pulse must satisfy the *<slope>* parameter you set with the `[CONFigure:]EXtErnal:INPut` command. The maximum allowable pulse voltage, minimum detectable pulse width and duty cycle are listed in “Input Pulses” on page 154.

If the recognized trigger event is a channel trigger, the pulse must satisfy the parameters you set with the most recent `[CONFigure:]TRIGger:SOURce CHANnel:EDGE` or `[CONFigure:]TRIGger:SOURce CHANnel:WINDow` command.

Use When: Use OR triggering when you need the flexibility to use external triggering but also need to recognize channel triggers from specified channels. You can set each channel’s trigger attributes differently. The digitizer will be triggered when it receives an external trigger pulse, or when a channel condition is satisfied, whichever comes first.

With the correct settings, multiple L4532A/34A digitizers can, using a common trigger bus, be triggered simultaneously or act as a trigger source for each other.

How To Specify: Configuring OR triggering requires a combination of these commands:

- Issue the `[CONFigure:]TRIGger:SOURce OR` command. This specifies OR triggering and turns on external triggering.
- Issue the `[CONFigure:]TRIGger:SOURce:CHANnel EDGE` command for any channel(s) you wish to accept an edge trigger.
- Issue the `[CONFigure:]TRIGger:SOURce:CHANnel WINDow` command for any channel(s) you wish to accept a window trigger.
- Issue the `[CONFigure:]TRIGger:SOURce:CHANnel OFF` command for any channel(s) you wish to ignore channel triggers.

Trigger Timing

The digitizer enters the Acquisition state immediately after the INITiate command is issued. While in the Acquisition state the digitizer samples continuously at 20MSa/s, storing (based on *<sample rate>*) a decimated subset of both pre-trigger and post-trigger samples in sample memory.

To the digitizer, a sample is a sample, whether it is digitized before or after the trigger occurs. To your host application, a sample datum is a sample datum. The only thing that distinguishes pre-trigger from post-trigger samples is the point in time that a given sample is taken. Therefore, it is important for you to understand precisely when sample 0 (the first post-trigger sample) occurs.

This section explains trigger timing concepts, and provides instructions for how to control trigger timing. We explore these concepts starting with a list of what determines trigger timing, then present several cases to illustrate when sample 0 occurs.

Impacts on Trigger Timing

Trigger timing is determined by:

- The specified *<sample_rate>*,
- The specified *<samples_per_record>*,
- The specified *<pre-trig_samples_per_record>*,
- The specified *<num_records>*,
- The specified *<trigger_holdoff>*,
- The specified *<trigger_delay>*,
- When the physical trigger event occurs,
- The digitizer's hardware sampling rate (20 MSa/s),
- The digitizer's minimum re-arm time (less than 300 ns).

You control the first six determinants of trigger timing by specifying the acquisition parameters with the [CONFigure:]ACQuisition[:ATTRIBUTES] command (see “Configuring Acquisition (Sampling and Record Storage) Attributes” on page 148 for complete syntax and instructions).

The seventh determinant is when the trigger event occurs, and you also control this, using the CONFigure:ARM and CONFigure:TRIGger command subsystems (see “Configuring the Arm and Trigger Sources” on page 149 and “Configuring External Trigger In/Out Connector Parameters” on page 154) and by sending trigger signals.

NOTE

For all examples in this section, the “moment” sample 0 is taken is accurate to within 12.5 ns of what is stated and shown in the diagrams; this is the digitizer’s timebase granularity.

Case 1: A Single Record Acquisition; Sample 0 is Taken At the Trigger Event

In the simplest case, you specify only one record per acquisition. Sample 0 is taken at the moment a configured trigger event occurs, assuming that:

- the digitizer is armed,
- the specified number of `<pre-trig_samples_per_record>` have already been taken,
- the trigger coincides exactly with a sample being taken at the specified `<sample_rate>`, and
- the specified `<trigger_delay>` is zero, and
- the specified `<trigger_holdoff>` is zero.

In this case, the trigger timestamp occurs at the moment of the trigger event. Sample 0 is always taken coincident with the trigger timestamp.

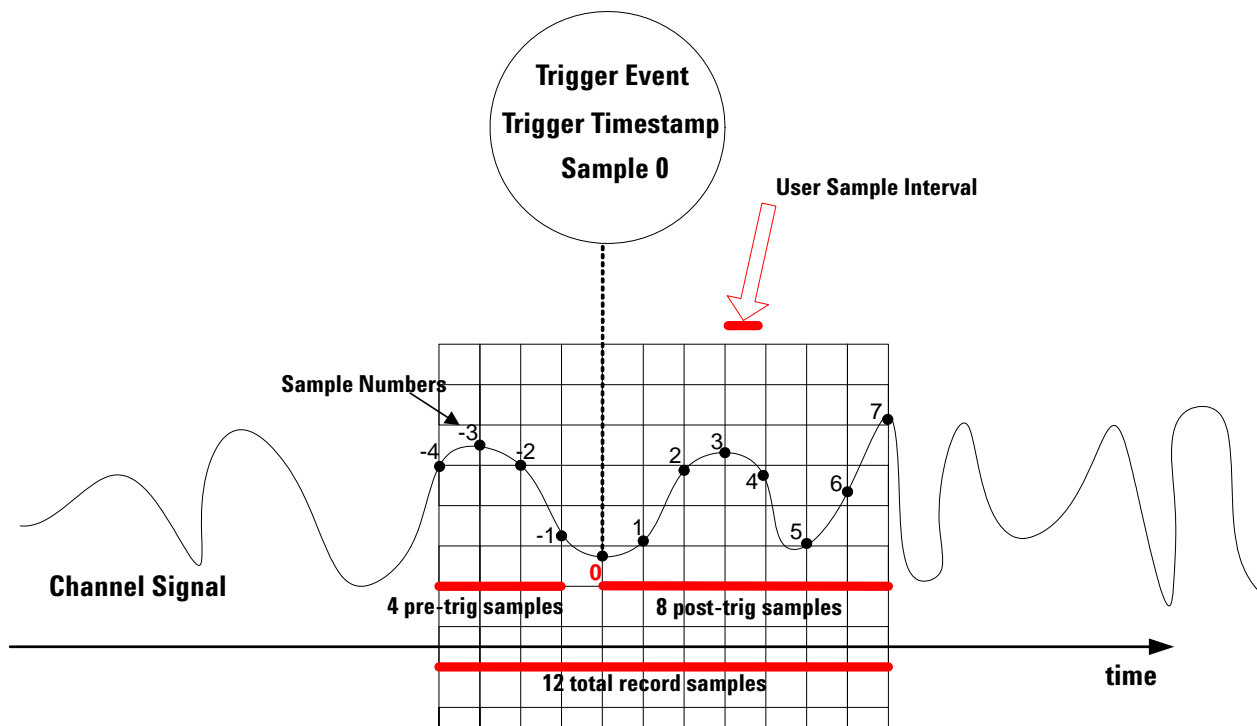

NOTE

For all examples in this section, negative sample numbers indicate pre-trigger samples; the post-trigger samples begin with sample 0. For simplicity, we show only a few pre- and post-trigger samples (in the required multiples of four). These samples are the samples stored by the digitizer, which may be a small subset of the actual hardware sampling continuously performed at 20 MSa/s; these samples reflect the user's configured `<sample_rate>`.

Case 2: Introducing Trigger Timestamp Latency:

This case is identical to Case 1 (a single-record acquisition), except that sample 0 may take place at a time later than the actual trigger event. This period of time is called trigger timestamp *latency*, measured in increments of the digitizer's minimum timebase resolution of 12.5ns. It may be caused when:

- You are using external triggering. The applied trigger pulse may occur between 20 MSa/s hardware samples, so the maximum latency this trigger setting could cause is 50ns. The latency would be larger at slower sample rates.
- You specify a `<sample_rate>` slower than the default 20 MSa/s, and the trigger does not coincide exactly with a sample being taken at that `<sample_rate>`; it occurs between these samples. Your sample rate setting instructs the digitizer to only store every n th sample, where n is the ratio of 20 MSa/s to `<sample_rate>`.

Example: If you specify a sample rate of 1 MSa/s, the digitizer will store only every 20th sample, and the latency from the trigger event until sample 0 could be as long as 1 μ s.

In this case, the trigger timestamp occurs—and sample 0 is taken—after the trigger event, by the amount of the timestamp latency.

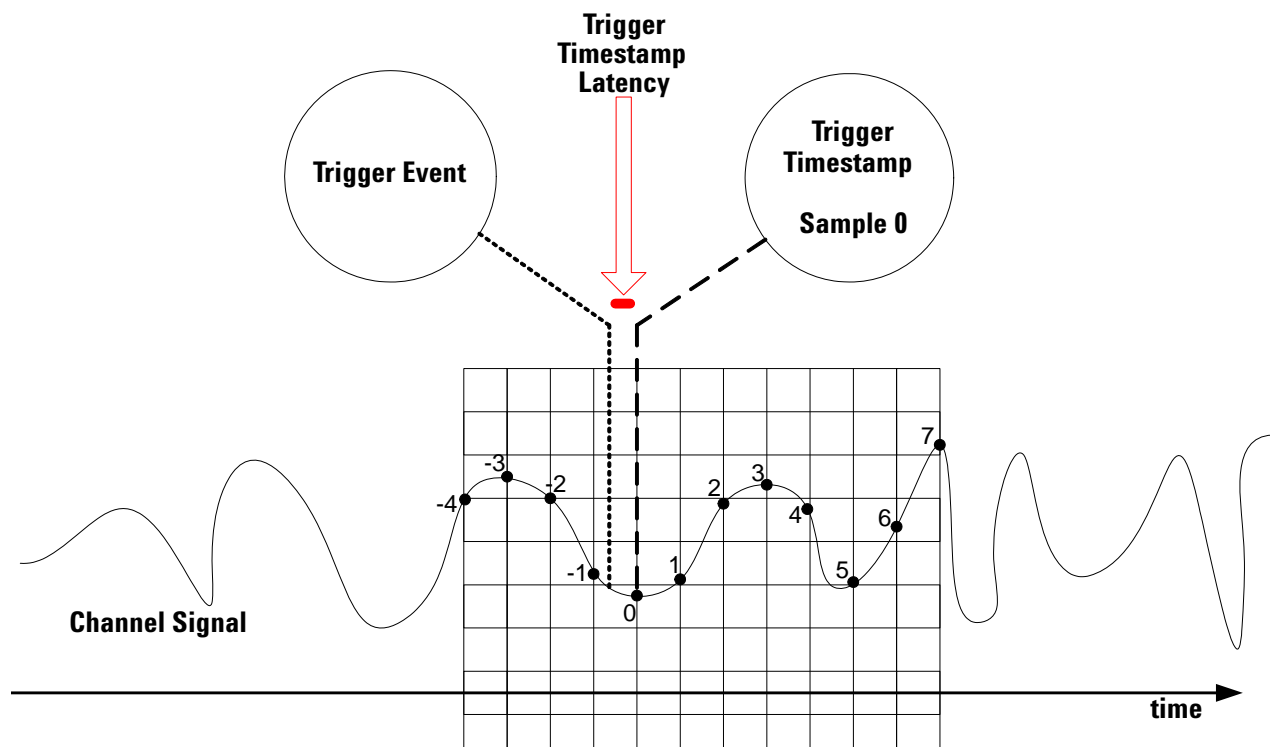

Case 3: Introducing Trigger Delay:

This case is identical to Case 2, except that a user-configured *trigger delay* must transpire between the actual trigger event and sample 0. Trigger timestamp latency may also apply, as in Case 2.

Use When: Use a trigger delay when you wish to delay the trigger timestamp by a fixed interval after the trigger.

How To Specify: Configure trigger delay with the `<trigger_delay>` parameter of the `[CONFIGure:]ACquisition[:ATTRIBUTES]` command.

In this case, the trigger timestamp occurs after the trigger event, by an amount equal to the sum of the trigger delay and timestamp latency.

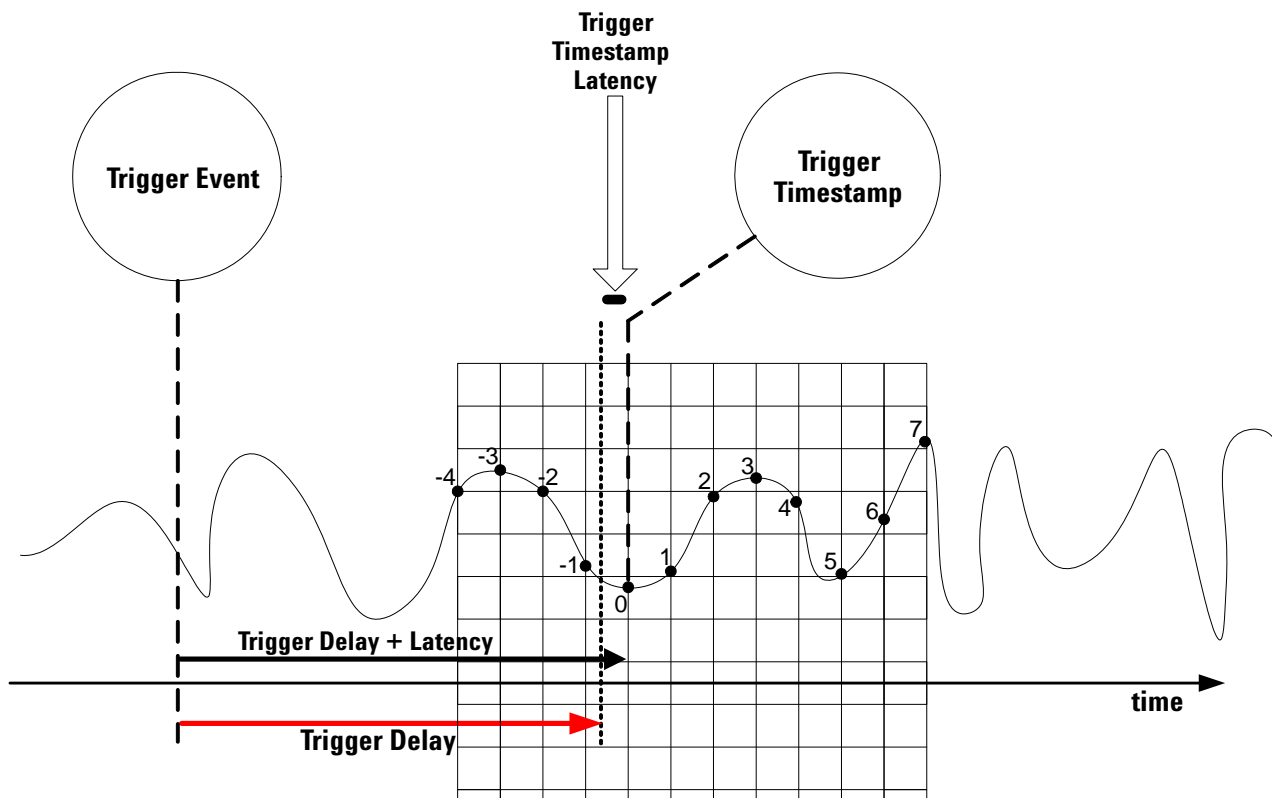

Case 4: Introducing Inter-Record Re-Arm Time and Implicit Trigger Holdoff:

This case is identical to Case 3, except that here you specify two records per acquisition. The digitizer must re-arm between records.

The first record is triggered as before. Before triggering can become *active* again (the digitizer can recognize the next trigger event), an *implicit trigger holdoff* period must transpire, consisting of:

- the time to take all configured post-trigger samples for record 1,
- a fixed inter-record re-arm time (typically less than 300 ns),
- the time to take the specified `<pre-trig_samples_per_record>` for record 2.

In the example below, triggering for record 2 becomes active after the fourth pre-trigger sample for record 2 is taken. These are not numbered, because only the last four pre-trigger samples are kept in the buffer.

Triggers which occur before the implicit trigger holdoff are ignored. The second trigger event must occur after the implicit trigger holdoff; then the trigger timestamp for record 2 occurs after the second trigger event, by an amount equal to the sum of the trigger delay and timestamp latency.

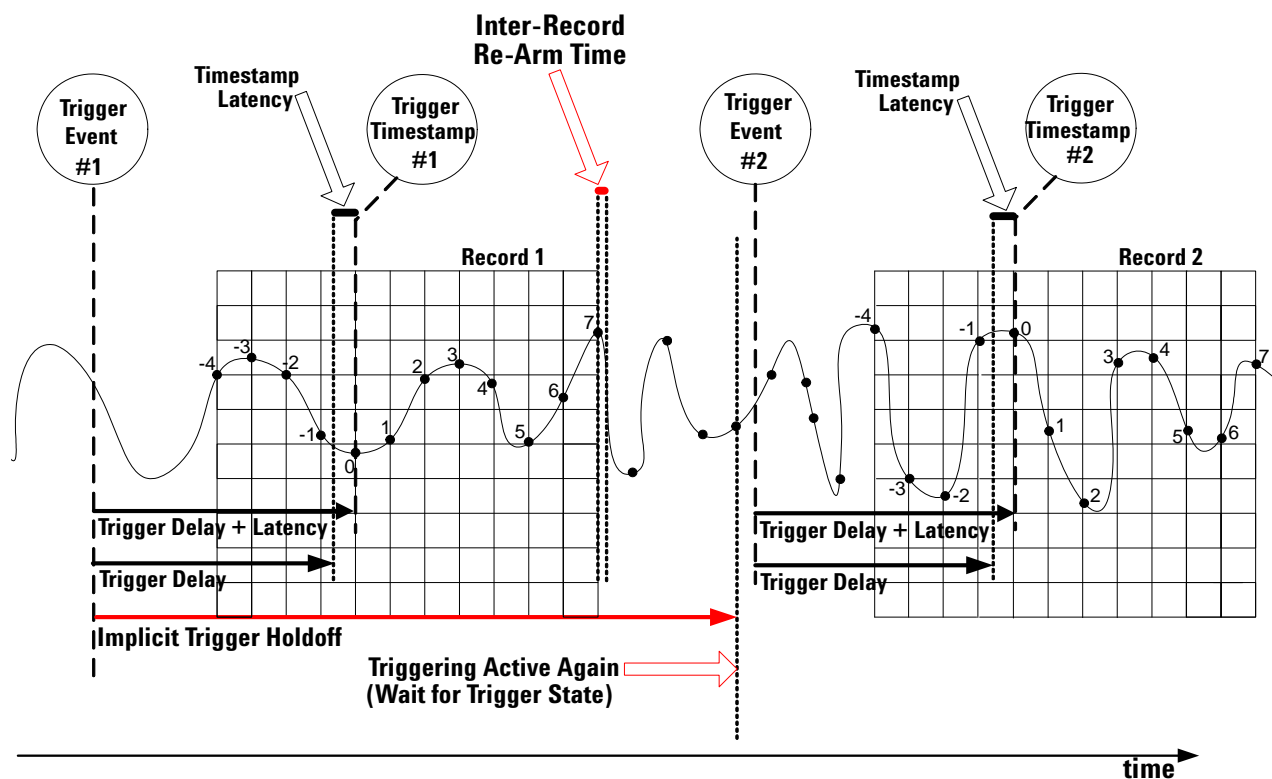

Case 5: Introducing the User-Configured Minimum Trigger Holdoff:

This case is identical to Case 4, except that a user-configured *minimum trigger holdoff* must transpire between accepted trigger events. This minimum trigger holdoff is the period of time you specify, after the last trigger event, during which any subsequent trigger is ignored.

The first record is triggered as before. Before triggering can become active again, the *actual* trigger holdoff period must transpire. The actual trigger holdoff the digitizer will use is the larger of the configured minimum trigger holdoff and the implicit trigger holdoff.

Use When: Specify a trigger holdoff when you wish to ignore subsequent triggers for a fixed time period, to allow the current acquisition to complete.

How To Specify: Configure the minimum trigger holdoff with the `<trigger_holdoff>` parameter of the `[CONFIGure:]ACQuisition[:ATTRIBUTES]` command.

Triggers which occur before the actual trigger holdoff are ignored. The second trigger event must occur after the actual trigger holdoff; then the trigger timestamp for record 2 occurs after the second trigger event, by an amount equal to the sum of the trigger delay and timestamp latency. Subsequent triggers are subject to the same actual trigger holdoff.

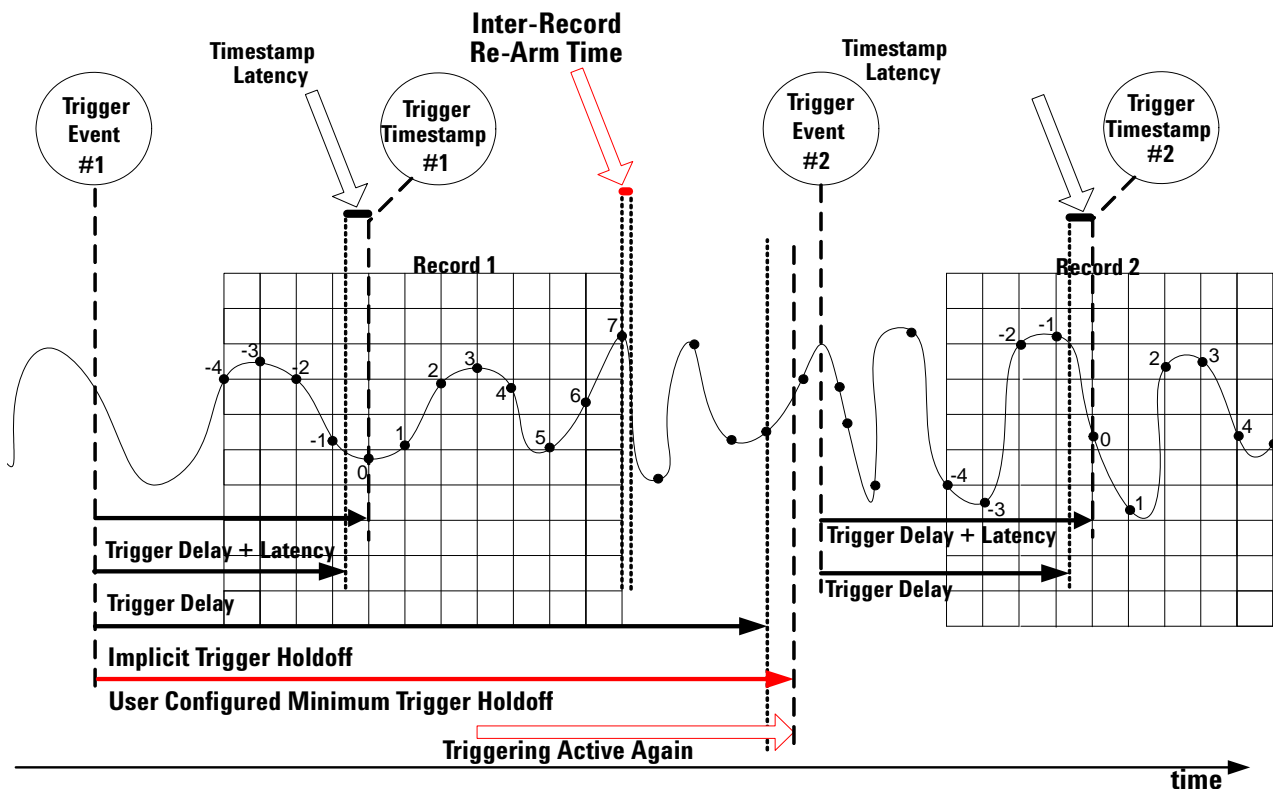

Data Retrieval Concepts and Choices

This section describes the options for retrieving data from the digitizer, to enable you to choose the options best suited for your application.

For retrieving data, you have five return data formats to choose from. All can be used for sample data; only the last three can be used for measurement data:

- Integer ADC16
- Integer ASCII
- Real32
- Real64
- Real ASCII

These five formats, and why you might choose them, are introduced in [“Selecting a Data Retrieval Format”](#) on page 128.

You can use one of two types of commands for sample data retrieval, FETCh and READ. The two choices, and why you might choose them, are introduced in [“Selecting Which Command To Use for Returning Sample Data”](#) on page 135.

When you configure acquisition and channel attributes, you determine how many total samples are stored during an acquisition. You have many choices that determine which of those samples (or values calculated from those samples) you actually retrieve with a FETCh or READ command. Those choices are:

- Retrieve data from single channel or channel list;
- Retrieve data from a single record or range of records;
- For each record, retrieve a count of samples from a defined start point in the record;
- From that count, retrieve a decimated subset of the samples;
- Choose from among three methods (subset of samples in the count, average value of those samples, minimum and maximum value from those samples) for data decimation;
- Select a decimation count to use with the chosen decimation method;

These choices, and why you might choose them, are introduced in [“Selecting Which Sample Data to Return”](#) on page 136.

Selecting a Data Retrieval Format

Specific formats apply if you are retrieving digitized sample data or on-board measurement (OBM) results calculated from the digitized samples. Your format choice may also be dictated by speed considerations (fewer bytes per sample improves data throughout), by the need for readability, and by your host application program.

The five choices for the return data format are summarized below.

Source of Data to be Returned	Integer or Real Values	Easily Readable by Humans?	Return Format	Size in Bytes, per Returned Value
Digitized Sample Data	Integer	No	Integer ADC16	2 bytes per sample
		Yes	Integer ASCII	2 to 6 bytes per sample
	Real (represents actual voltages)	No	Real 32	4 bytes per sample
		Yes	Real ASCII	13 bytes per sample
Measurement Data	Real	No	Real 32	4 bytes per sample
			Real 64	8 bytes per sample
		Yes	Real ASCII	13 bytes per sample

Configuration instructions for these return data choices follow.

Before choosing a return format, it is important to understand the digitizer's native format for storing sample data, ADC16.

ADC16, The Digitizer's Native Storage Format

The 16-bit resolution of the L4532A/34A digitizers translates into a full-scale range of 2^{16} levels, ranging from -32767 to +32767. The digitizer converts each sampled analog voltage to a 16-bit signed 2's complement number and stores these numbers in a native format called ADC16 (analog-to-digital conversion; 16-bit). The following table illustrates the ADC16 format and the values each ADC16 code represents:

ADC16 Code	Represented Integer Value
01111111 11111111	+32767 (overload; positive full scale)
00000000 00000011	+3
00000000 00000010	+2
00000000 00000001	+1
00000000 00000000	0
11111111 11111111	-1
11111111 11111110	-2
11111111 11111101	-3
10000000 00000001	-32767 (overload; negative full scale)
10000000 00000000	-32768 (error; no data available)

The Integer ADC16 Return Format

Integer ADC16 format returns binary data corresponding to the integer ADC codes from -32767 to +32767.

Use When: Use Integer ADC16 format to maximize data throughput speed when obtaining sample data. ADC16 format requires essentially no CPU effort to convert the output from the digitizer's native storage format, and transfers the smallest number of bytes of data per sample.

Use With: The two queries that can return Integer ADC16 data are `FETCH:WAVEform:ADC?` and `READ:WAVEform:ADC?`.

How to Specify: Specify the Integer ADC16 format by issuing this command:

```
FORMat[:DATA]:INTeger INTeger
```

What It Returns: Each ADC code is returned as a 16-bit signed 2's complement number consisting of two bytes. The default byte order is Big-Endian (MSB first). You may reverse the byte order to Little-Endian using the `FORMat:BORDER` command (see [“Selecting the Byte Order for Returned Binary Data”](#) on page 134).

Converting Returned Values: To convert the returned binary values to actual voltages; first convert each 2's complement result to its equivalent integer value, then use the following formula:

$$V = \text{equivalent integer value} * \text{Range} / 32767$$

where 32767 is the ADC code representing full scale

Example: If a returned ADC16 value is 00000000 01101101, the default byte order is selected, and the range is 128 V;

then the equivalent integer value is $1 + 4 + 8 + 32 + 64 = +109$
and $V = +109 * 128 / 32767 = +0.4258 \text{ V}$

The Integer ASCII Return Format

Integer ASCII format returns human-readable ASCII characters corresponding to the integer ADC codes from -32767 to +32767.

Use When: Use Integer ASCII format when you need human-readable data, for test validation and debugging. However, retrieving data in ASCII format is very slow, because each character is transmitted as an individual byte. Long responses could occur; in those cases the digitizer will generate an error message, instructing you to use the Integer ADC16 format.

Use With: The two queries that can return Integer ASCII data are `FETCh:WAVEform:ADC?` and `READ:WAVEform:ADC?`.

How to Specify: Specify Integer ASCII format by issuing this command:

```
FORMat[:DATA]:INTeger ASCii
```

What It Returns: Each sample is returned as one to six ASCII characters, where:

- The first character is either blank, - (the negative sign character) or 0.
- If the ASCII value is not zero, the remaining characters (two through six, as needed) represent the value of the number, from 1 to 32767.

Converting Returned Values: To convert the returned integer values to actual voltages, use the following formula:

```
V = integer value * Range / 32767  
where 32767 is the ADC code representing full scale
```

Example: If a returned integer value is -4681, and the range is 64 V;

```
then V = -4681 * 64 / 32767 = -9.143 V
```

The Real 64 Return Format

Real 64 format returns real (floating-point) numbers. For sample data, the numbers represent actual waveform voltage levels from -256V to +256V. For calculated measurement results, the numbers represent values in volts, ohms, seconds, hertz or percent.

Use When: Use Real64 when your host application requires double-precision floating point data. Real64 takes twice as many bytes per returned value as Real 32, and should be used only if your application requires it.

Use With: The three queries that can return Real 64 data are `FETCh:WAVEform:VOLTage?`, `READ:WAVEform:VOLTage?`, and `MEASure:INSTall:RESults[:RECORD][:VERBose]?`.

How to Specify: Specify Real 64 format by issuing this command:

```
FORMat[:DATA]:REAL REAL,64
```

What It Returns: Each value is returned as 64 bits following the standard IEEE-754 floating-point format, where:

- Bit 1 is the sign bit, where 0 indicates a positive floating-point number and 1 indicates a negative floating-point number.
- Bits 2 through 12 comprise an 11-bit base-2 biased exponent, e .
- Bits 13 through 64 comprise a 52-bit *fraction* (the significand without its msb), with the next most significant bit first.
- The exponent biased by $(2^{e-1}) - 1$, where e is the number of bits used for the exponent field. In Real64 format, the exponent field e is 11 bits wide. To represent a number with an exponent of 12:

$$e = 12 + (2^{11-1}) - 1 = 12 + 1024 - 1 = 1035 \text{ (in base-10).}$$

The exponent field would therefore be 10000001011.

The 64 bits are returned as eight bytes. The default byte order is Big-Endian (MSB first). You may reverse the byte order to Little-Endian using the `FORMat:BORDER` command (see [“Selecting the Byte Order for Returned Binary Data”](#) on page 134).

The Real ASCII Return Format

Real ASCII format returns human-readable ASCII characters corresponding to real (floating-point) numbers. For sample data, the numbers represent actual waveform voltage levels from -256V to +256V. For calculated measurement results, the numbers represent values in volts, ohms, seconds, hertz or percent.

Use When: Use Real ASCII format when you need human-readable data, for test validation and debugging. However, retrieving data in ASCII format is very slow, because each character is transmitted as an individual byte. Long responses could occur; in those cases the digitizer will generate an error message, instructing you to use either the Real 32 or Real 64 format.

Use With: The three queries that can return Real ASCII data are `FETCH:WAVEform:VOLTage?`, `READ:WAVEform:VOLTage?`, and `MEASure:INSTall:RESults[:RECORD][:VERBose]?`.

How to Specify: Specify Real ASCII format by issuing this command:

```
FORMat[:DATA]:Real ASCII,7
```

What It Returns: Each value is returned as 13 ASCII characters. For example, `+1.234567E+02` represents the base-ten number 123.4567.

Selecting the Byte Order for Returned Binary Data

This command applies only when you request the digitizer to return binary data using one of these commands:

```
FORMat[:DATA]:INTeger Integer
FORMat[:DATA]:REAL REAL, 32
FORMat[:DATA]:REAL REAL, 64
```

By default, the digitizer returns binary data in Big-Endian (NORMAL) byte order. Big-Endian byte order tells the digitizer to transmit data with its most significant byte (the big end) first; swapped, Little-Endian (SWAPPed) byte order transmits the least significant byte (the little end) first.

Use When: Use Little-Endian byte order when your computer's processor architecture or software dictates it.

How to Specify: Select the byte order in which binary data (whether in integer or floating point format) is returned by issuing this command:

```
FORMat:BORDER <mode>
```

Example: The following command selects swapped (Little-Endian) byte order for the returned data.

```
FORM:BORD SWAP
```

Selecting Which Command To Use for Returning Sample Data

Four queries return sample data:

```
FETCh:WAVeform:ADC?  
FETCh:WAVeform:VOLTage?  
READ:WAVeform:ADC?  
READ:WAVeform:VOLTage?
```

When to Use a FETCh Query

Once records are written to sample memory, you can repeatedly retrieve sample data and preamble data as needed using one of the FETCh queries. The data from the last acquisition remains in sample memory until you send the next INITiate command, send a *RST command, cycle power, or change configuration settings (this may cause existing data to become *stale* (see “[Stale Data Errors](#)” on page 74). If you need to retrieve data more than once per acquisition, you must use FETCh. For a complete discussion of the FETCh queries, see “[Retrieving Sample Data Using the FETCh Queries](#)” on page 161.

When to Use a READ Query

The INITiate command clears all data from sample memory. You can also clear sample memory by issuing either of the two READ queries (READ:WAVeform:ADC? or READ:WAVeform:VOLTage?), which issue an INITiate command to begin a new acquisition, then automatically retrieve the data after acquisition completes. For example:

```
READ:WAV:ADC? (@1) = INIT;: FETCh:WAV:ADC? (@1)
```

Therefore, a READ query can only be used once per acquisition, but offers some speed advantages over FETCh, and is useful if you are sure your acquisition will complete without errors. In all other ways, the READ queries work exactly like their FETCh counterparts. For a complete discussion of the READ queries, see “[Retrieving Sample Data Using the READ Queries](#)” on page 167.

Which FETCh or READ Query to Use

Use FETCh:WAVeform:ADC? or READ:WAVeform:ADC? in conjunction with FORMat[:DATA]:INTeger to retrieve ADC code data.

Use FETCh:WAVeform:VOLTage? or READ:WAVeform:VOLTage? in conjunction with FORMat[:DATA]:REAL to retrieve voltage data.

Selecting Which Sample Data to Return

Using the [CONFigure:]ACQuisition[:ATTRIBUTES] command, you determine how many samples will be captured in sample memory during a normal complete acquisition beginning with INITiate. That number will be equal to $\langle \text{num_records} \rangle * \langle \text{samples_per_record} \rangle$. To ensure that you capture significant data points in your sampled waveform (such as voltage peaks, transients, rise/fall times, ringing or settling time), you may well capture more samples than you subsequently need to retrieve.

The four FETCh and READ commands briefly described on [page 135](#) all provide choices for specifying—from all samples in sample memory—the subset of sample data to return. In this section we will explore these choices and discuss when you might use them. For simplicity, the examples will all use the FETCh:WAVEform:ADC? query and all specify channel 1, but they apply to any of the four queries.

Parameter Choices for Data Return

Below are the parameter choices common to all four queries:

- ($\langle @\text{chan_list} \rangle$): You may retrieve data from a single channel, a comma-separated list in ascending order, or a range of channels in ascending order. You may specify one, two or four channels, but not three.
- $\langle \text{start} \rangle$: From each record you specify using $\langle \text{rec_Range} \rangle$, this parameter indicates the first sample to retrieve.
- $\langle \text{count} \rangle$: From each record you specify using $\langle \text{rec_Range} \rangle$, this parameter indicates how many samples to retrieve.
- $\langle \text{rec_range} \rangle$: You may retrieve data from a single record or a range of records.
- $\langle \text{decType} \rangle$: From the set of samples indicated by $\langle \text{rec_Range} \rangle$, $\langle \text{start} \rangle$, and $\langle \text{count} \rangle$, this parameter specifies that only a decimated subset of samples or calculated values are returned. You have three choices of decimation type, narrowed by specifying n , the $\langle \text{decCount} \rangle$ parameter:
 - $\langle \text{decType} \rangle = \text{DATA}$: The default, DATA decimation returns only every n th sample from the set of samples.
 - $\langle \text{decType} \rangle = \text{AVERage}$: AVERage decimation returns only the average value from each subset of n values from the set of samples.
 - $\langle \text{decType} \rangle = \text{MINMax}$: MINMax decimation returns the minimum and maximum samples from each subset of n values from the set of samples.
- $\langle \text{decCount} \rangle$: This parameter indicates the decimation count n to be used in conjunction $\langle \text{decType} \rangle$.

Data Return Without Decimation

The options listed on this page use the `<chan_list>`, `<start>`, `<count>`, and `<rec_range>` parameters only.

To Retrieve All Sample Data from Record 1 To retrieve all samples—including both pre-trigger and post-trigger readings—from record 1 on channel 1 only, use the default parameter settings:

```
FETC:WAV:ADC? (@1)
```

To Retrieve a Range of Samples from Record 1 To retrieve a specific range of samples—this may include a subset of pre-trigger and post-trigger readings, all or neither of both—from record 1 on channel 1 only; specify `<start>` and `<count>`. This example returns 100 pre-trigger samples and 1000 post-trigger samples:

```
FETC:WAV:ADC? (@1),-100,1100
```

To Retrieve a Range of Samples from Any Record(s) To retrieve a specific range of samples from more than one record or from a record other than record 1, specify `<start>`, `<count>`, and `<rec_range>`. This example returns 100 pre-trigger samples and 1000 post-trigger samples from each of records 1 to 3 on channel 1:

```
FETC:WAV:ADC? (@1),-100,1100,(@1:3)
```

Even if you want all samples from multiple records, you must specify `<start>` and `<count>` for the digitizer to recognize the lower level parameter `<rec_range>`.

To Retrieve All Samples in the Acquisition To retrieve all samples (both pre- and post-trigger) from all records acquired, specify `<start>`, `<count>`, and `<rec_range>`; and be certain to:

```
set <start> to -<pre-trig_samples_per_record>,
set <count> to <pre-trig_samples_per_record> +
<samples_per_record>, and
set to <rec_range> to (@1:<num_records>).
```

So if:

```
<pre-trig_samples_per_record> = -32,
<samples_per_record> = 500, and
<num_records> = 10;
```

Then this example will return all samples in the acquisition for channel 1:

```
FETC:WAV:ADC? (@1),-32,500,(@1:10)
```

Data Return Using the Decimation Feature

You may digitize a large amount of data per record at a high sampling rate to ensure thorough data capture, but do not need to return all stored values—and would like to improve speed of data throughput—with a given FETCh or READ query. For that purpose, you have three choices to return *decimated* data:

- DATA decimation (described on [page 138](#))
- AVERAge decimation (described on [page 139](#))
- MINMax decimation (described on [page 140](#))

Each type of decimation requires that you specify a *decimation type* `<dec_type>` and a *decimation count* `<dec_count>`, which we'll call *n* for this discussion.

Even if you wish to use default values (with your FETCh or READ query) for `<start>`, `<count>`, and `<rec_range>`, you must specify them for the digitizer to recognize the lower level parameters `<dec_type>` and `<dec_count>`.

DATA Decimation

DATA decimation allows you to specify `<chan_list>`, `<start>`, `<count>`, and `<rec_range>`; then return just every *n*th sample from each `<count>`.

Use When: Use DATA decimation when you set a high sampling rate (applies to all channels) but may not need all data points from each channel. For instance, you may have needed 20 MSa/s for channel 1 to capture a transient signal, but may only need 1 kSa/s results from channel 2.

How to Specify: Specify `<start>`, `<count>`, `<rec_range>`, `<dec_type>` = DATA, and `<dec_count>`.

To illustrate this, we will use the example from [page 137](#), where we returned 100 pre-trigger samples and 1000 post-trigger samples from each of records 1 to 3:

```
FETC:WAV:ADC? (@1),-100,1100,(@1:3)
```

Example: The query below returns every fifth sample from the range specified above; 20 pre-trigger samples and 200 post-trigger samples from each of records 1 to 3:

```
FETC:WAV:ADC? (@1),-100,1100,(@1:3),DATA,5
```

AVERage Decimation

AVERage decimation allows you to specify *<chan_list>*, *<start>*, *<count>*, and *<rec_range>*; then return just the average value from each group of *n* samples in each *<count>*.

Use When: Use AVERage decimation when want to take advantage of the digitizer's high sampling rate to capture as many data points as possible, but only need to use average values from each portion of the waveform. This provides more resolute results than using a lower sampling rate, for these reasons:

- Using a high resolution acquisition (use the maximum sampling rate possible given the duration of the event you wish to capture) has less chance of missing key transients. The result reflects all samples captured.
- Average decimation creates a slower effective sample rate from the high resolution acquisition with the benefit of reduced signal noise content (because each *n* samples are averaged).

There are some speed trade-offs you should consider. The digitizer's front end always samples at 20MSa/s, so storing samples from a high sampling rate does not slow it down. But specifying decimation does require some processing time during the FETCh or READ.

How to Specify: Specify *<start>*, *<count>*, *<rec_range>*, *<dec_type>* = AVERage, and *<dec_count>*.

To illustrate this, we will again use the previous example, where we returned 100 pre-trigger samples and 1000 post-trigger samples from each of records 1 to 3:

Example: The query below returns the average value of each set of 100 samples from the range specified above; one pre-trigger average value and 10 post-trigger average values, from each of records 1 to 3:

```
FETC:WAV:ADC? (@1),-100,1100,(@1:3),AVER,100
```

MINMax Decimation

MINMax decimation allows you to specify *<chan_list>*, *<start>*, *<count>*, and *<rec_range>*; then return just the minimum and maximum samples from each group of *n* samples in each *<count>*.

MINMax decimation returns actual digitized samples from the input signal, as compared to the on-board measurements VMIN and VMAX, which calculate statistical minimum and maximum values from the sample data using a histogram algorithm.

Use When: MINMax decimation has many uses. Two cases illustrate this convenient feature:

- You are measuring a signal including a voltage spike. You may wish to sample at a high rate to ensure you capture the peak, but do not need to return the entire set of sample data to identify the peak, just the maximum value over a given range.
- You are testing a device characteristic with upper and lower bounds. Retrieving only the MIN and MAX values from an acquisition can facilitate bounds checking.

How to Specify: Specify *<start>*, *<count>*, *<rec_range>*, *<dec_type>* = MINMax, and *<dec_count>*.

To illustrate this, assume you have done previous acquisitions of a signal, know that the trigger occurred on the rising edge of the signal, and you sampled at a rate fast enough to ensure that the peak occurs 100-150 samples past the trigger timestamp. For subsequent production testing, you only need to obtain this peak voltage value.

Example: The query below returns the minimum and maximum values from a single set of 300 samples beginning with the 100th pre-trigger sample and ending with the 200th post-trigger sample, from record 1:

```
FETC:WAV:ADC? (@1),-100,300,(@1),MINM,300
```

Understanding the Returned Data: Bytes, Blocks, and Lists

The data returned by a FETCh or READ query depends on:

- The specific FETCh query you issue to return the data:
 - FETCh:WAVeform:ADC? returns ADC codes
 - FETCh:WAVeform:VOLTage? returns real voltage values
- The specific FORMat command and its parameters you used to specify the return format. ASCII data is returned in a comma-delimited list without a header; all other formats are returned in a definite length data block with header.
- The channel list, starting sample, sample count and record range you specify.
- Whether you choose data decimation.

Data Returned Via the Host Application

For each combination of the FORMat:DATA and FETCh commands, the nature of the data return (block or list) is indicated below:

FORMat Command	FETCh Query	Description of the Return Block or List
FORMat[:DATA]:INTEger INTEger	FETCh:WAVeform :ADC?	Using Integer ADC16 format, these commands return a definite block, with a header and two bytes per returned value. Each pair of bytes comprises a 16-bit integer, with possible values from -32767 to +32767. It is the most compact return format.
FORMat[:DATA]:INTEger ASCii		Using Integer ASCII format, these commands return a comma-delimited list of ASCII values, with two to six bytes per returned value.
FORMat[:DATA]:REAL REAL,32	FETCh:WAVeform :VOLTage?	Using Real32 format, these commands return a definite block, with a header and four bytes per returned value.
FORMat[:DATA]:REAL REAL,64		Using Real64 format, these commands return a definite block, with a header and eight bytes per returned value.
FORMat[:DATA]:REAL ASCii		Using Real ASCII format, this command sequence returns a comma-delimited list of ASCII values, with thirteen bytes per returned value.

The Data Block Header

The definite length data blocks returned by the L4532A/34A begin with a block *header*. Consistent with the IEEE standard, the header begins with a pound (#) sign, followed by two fields. The first field is a single byte, the binary representation of 9; for this digitizer there are always nine digits in the byte count. The second field in the header is nine decimal bytes long; taken together the represented decimal gives the block's byte count.

For example, the header #9000000334 means that the byte count consists of 9 bytes, and that 334 bytes of data follow the header.

Structure of the Return Data Block or List

Whether the return data is in the form of a definite block or a comma-delimited list, the data is returned in a specific order, governed by these rules:

- Definite block data is preceded by a header which indicates how many bytes of data follow the header. List data has no header.
- Records are returned in ascending order by record number, regardless of the order specified in the FETCh command.
- Within each record, samples are returned in ascending order, beginning with *<start>* and ending with [*<start>* + *<count>* - 1].
- If you specify decimated fetching (decimation count = *n*), the samples are still returned in the order governed by the rules above, but:
 - For DATA decimation, only every *n*th sample from the sample count is returned.
 - For AVERage decimation, only the average value of every consecutive group of *n* samples in the count is returned.
 - For MINMax decimation, only the minimum and maximum values from every consecutive group of *n* samples are returned (example: MinCh₁, MinCh₂, MinCh₃, MinCh₄, MaxCh₁, MaxCh₂ MaxCh₃, MaxCh₄).
- For each sample or decimated value to be returned, the values from each specified channel are returned in ascending order.

The following diagram illustrates the order of returned data. For simplicity, the diagram assumes that:

- The digitizer is an L4534A and data is being fetched from all four channels; if an L4532A is used or fewer channels are specified, only their values are returned.
- Records from 1 to *r* have been specified in the FETCh query.
- Samples from 1 to *s* have been specified in the FETCh query

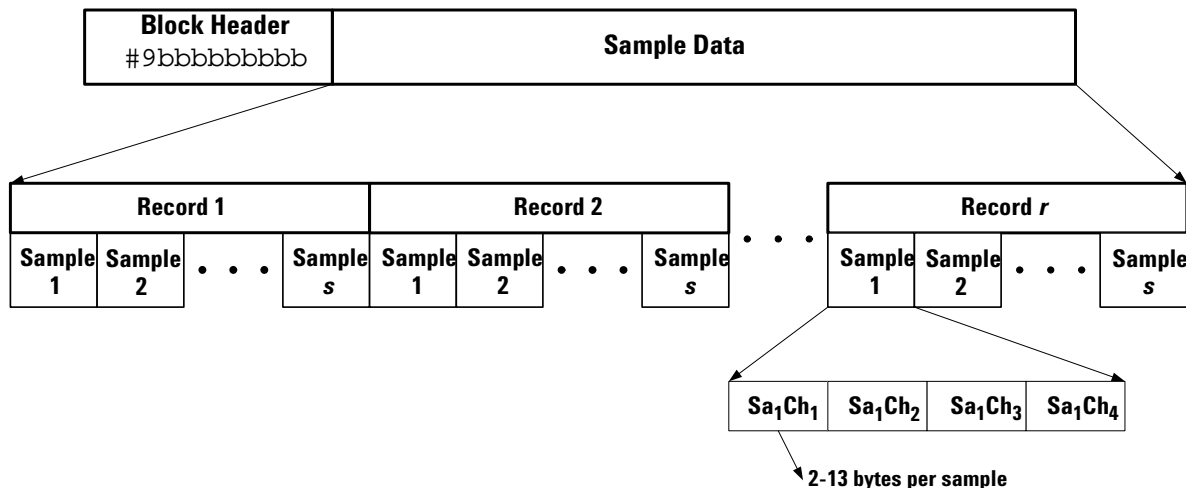

Data Returned Via the Web Interface

From the Web Interface, the data returned from a FETCh query is intended to help you learn and troubleshoot digitizer operation. Thus the Web Interface formats binary data in a human-readable format.

For small block data returns, the header is a # sign followed by a nine-digit integer representing the number of bytes in the block; each byte is returned as its hexadecimal representation.

For small ASCII returns, the query returns a comma-delimited string of signed integers representing the ADC codes.

If you specify large data returns, only the first 1000 bytes are displayed.

The examples below all return a single value (roughly -5 V).

Example (Integer ADC format):

```
FORM:INT INT
FETC:WAV:ADC? (@1),1,1
```

Typical Response:

```
#9000000002<0xb0><0x6e>
```

Example (Integer ASCII format):

```
FORM:INT ASC
FETC:WAV:ADC? (@1),1,1
```

Typical Response:

```
-20370
```

Example (Real32 format):

```
FORM:REAL REAL,32
FETC:WAV:VOLT? (@1),1,1
```

Typical Response:

```
#9000000004<0xc0><0x9f><0x25><0x3e>
```

Example (Real64 format):

```
FORM:REAL REAL,64
FETC:WAV:VOLT? (@1),1,1
```

Typical Response:

```
#900000008<0xc0><0x13><0xe4><0xa7><0xc9><0x4f><0x92><0x9f>
```

Example (Real ASCII format):

```
FORM:REAL ASC
FETC:WAV:VOLT? (@1),1,1
```

Typical Response:

```
-4.973296E+00
```

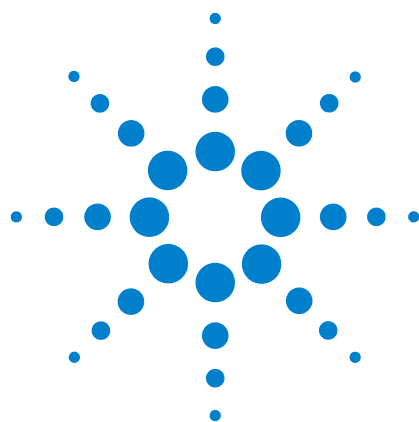
6 Detailed Configuration and Operating Instructions

This chapter provides detailed instructions for configuring most digitizer functions and for data retrieval; addresses synchronizing multiple digitizers for high channel-count applications; describes when and how to use the digitizer's on-board measurement capabilities; and provides a guide to system-related functions.

Configuring the Digitizer	146
Configuring Channel Attributes	147
Configuring Acquisition (Sampling and Record Storage) Attributes	148
Configuring the Arm and Trigger Sources	149
Configuring External Trigger In/Out Connector Parameters	154
Acquiring and Transferring Data	158
Retrieving Sample Data Using the FETCH Queries	161
Retrieving Sample Data Using the READ Queries	167
Synchronizing Multiple Digitizers	168
Making On-Board Measurements	169
Comparing Installed and Discrete Measurements	170
How the L4532A/34A Derives Calculated Measurements	171
Manually Specifying Measurement Parameters	180
Making Measurement Queries	187
Installed Measurements	194
System-Related Operations	197
Configured Instrument States	198
Display Features	202
Self Test	205
Calibration	207
Instrument Conditions	208
Safe State	208
Secure State	209



Configuring the Digitizer

The digitizer's CONFIGure command subsystem allows you to set:

- Channel attributes for each input channel: voltage range, AC or DC coupling, low-pass filter, and channel input protection. See [“Configuring Channel Attributes”](#) on page 147.
- Sample acquisition and record storage attributes applicable to all channels: sampling rate, number of records, number of pre-trigger and post-trigger samples to acquire per record, trigger holdoff, and delay timing. See [“Configuring Acquisition \(Sampling and Record Storage\) Attributes”](#) on page 148.
- Arm and trigger source parameters: source, number of triggers per arm, channel signal triggering parameters (used for edge triggering or window triggering), external arm or trigger slope. See [“Configuring the Arm and Trigger Sources”](#) on page 149.
- External triggering parameters: trigger event, TTL trigger pulse logic, and impedance. See [“Configuring External Trigger In/Out Connector Parameters”](#) on page 154.
- Trigger timestamp mode: how and when the timestamp counter is reset to 0. See [“Configuring Trigger Timestamp Mode”](#) on page 157.

Configuring Channel Attributes

You may configure range, coupling, and low-pass filtering for each channel independently. You can configure any single parameter, or all at once.

To configure all three at once, use this command:

```
[CONFigure:]CHANnel[:ATTRibutes]
(@<chan_list>),<range>[,<coupling>[,<filter>]]
```

- *<chan_list>* The channel(s) to which the specified channel attributes apply.
- *<range>* The voltage range:
.25, .5, 1, 2, 4, 8, 16, 32, 64, 128 or 256 (default).
- *<coupling>* The coupling mode:
AC, DC (default).
- *<filter>* The low-pass filter setting:
LP_200_KHZ, LP_2_MHZ, or LP_20_MHZ (default).

Example: The following specifies a 32 V range, AC coupling, and a 2 MHz low-pass filter, for channels 2 and 3.

```
CONF:CHAN:ATTR (@2,3), 32, AC, LP_2_MHZ
```

To configure just one of these three channel parameters, you can enter commands similar to those shown below. The keyword after CHANnel specifies which parameter you are setting.

```
CONFigure:CHANnel:RANGe (@1), 64
CONFigure:CHANnel:COUPLing (@1:2), AC
CONFigure:CHANnel:FILTer (@3), LP_200_KHZ
```

Channel Overvoltage Protection

To turn the input (overvoltage) protection relay on or off for each channel (or a list of channels), use this command:

```
[CONFigure:]CHANnel:ATTRibutes:PROTection
[:RELay](@<chan_list>),<mode>
```

- *<chan_list>* The channel(s) for which you are selecting the input protection mode.
- *<mode>* The state of the input protection relay:
ON, OFF (default).

Example: The following command turns the input protection relay on for channel 3, in anticipation of a +300V signal during testing.

```
CHAN:ATTR:PROT (@3),ON
```

Configuring Acquisition (Sampling and Record Storage) Attributes

You may specify six sampling and record storage attributes; these affect all input channels. You can configure any single parameter or all at once.

To configure all six at once, use the command:

```
[CONFigure:]ACQuisition[:ATTRIBUTES] <sample_rate>,
[<samples_per_record> [,<pre-trig_samples_per_record>
[,<num_records> [,<trigger_holdoff>
[,<trigger_delay>]]]]]
```

- *<sample_rate>* The number of samples per second to be acquired: 1000, 2000, 5000, 10000, 20000, 50000, 100000, 200000, 500000, 1000000, 2000000, 5000000, 10000000, or 20000000 (default).
- *<samples_per_record>* The total number of samples (pre-trigger plus post-trigger) to be stored per record. The digitizer will coerce your value up to the nearest multiple of four. The minimum is eight; the maximum depends on your installed memory. The default is 2048. Send [CONFigure:]ACQuisition:SCOUNT:MAXimum? to find the maximum *<samples_per_record>* for a specified number of records.
- *<pre-trig_samples_per_record>* The number of samples before the trigger event to be stored per record. The digitizer will coerce your value up to the nearest multiple of four. The minimum (default) is 0. The maximum is your record size minus four.
- *<num_records>* The number of records (triggers accepted) in an acquisition. Specify any unsigned integer from 1 (default) to 1024.
- *<trigger_holdoff>* The minimum period in seconds following a trigger, during which trigger events are ignored. Specify any unsigned floating point number from 0 (default) to 10, in 50 ns increments.
- *<trigger_delay>* The minimum period in seconds following a trigger, before sample 0 is taken. Specify any unsigned floating point number from 0 (default) to 3600. The digitizer may coerce your entry down with a granularity of 1/*<sample rate>*.

Example: The following command specifies a 20 MSa/s sample rate, 12 samples per record, 8 pre-trigger samples per record, 3 records, a zero trigger holdoff, and a 10 second trigger delay.

```
CONF:ACQ 2.0E+07,12,8,3,0,10
```

To configure just one of these six acquisition parameters, you can enter commands similar to those shown below. The keyword after ACQuisition specifies which parameter you are setting.

```
CONFigure:ACQuisition:SRATe (@1), 2.0E+07
CONFigure:ACQuisition:SCOUNT (@1:2), 12
CONFigure:ACQuisition:SPReTrigger (@3), 8
CONFigure:ACQuisition:RECORDS (@1), 3
CONFigure:ACQuisition:THOLDoff (@1:2), 0
CONFigure:ACQuisition:TDELay (@3), 10
```

Configuring the Arm and Trigger Sources

Arming and triggering configuration is described below.

Configuring the Arming source

To select the arm method and specify the number of triggers per arm, use this command:

```
[CONFigure:]ARM:SOURce <source>[,<triggers_per_arm>]
```

- <source> The selected method of arming the digitizer: IMMEDIATE (default), EXTERNAL, SOFTWARE or TIMER.
- <triggers> The number of triggers the digitizer will accept per arm event. Specify any unsigned integer from 1 to 1024 (default).

Example: The following command sets the arm source to external and specifies 10 triggers per arm.

```
CONF:ARM:SOUR EXT,10
```

Setting the External Arm Signal's Slope

This command applies to the external arm (and trigger) modes only.

To specify the arm signal's slope (the edge of the applied external arming pulse that the digitizer will recognize), use this command:

```
[CONFigure:]EXternal[:INPut] <slope>
```

<slope> specifies the edge: POSITIVE (default) or NEGATIVE.

Example: The following command sets a negative external arm slope.

```
CONF:EXT:INP NEG
```

Setting the Arm Timer

This command applies to the arm timer mode only.

To specify the number of seconds for the arm timer to count down before arming, use this command:

```
[CONFigure:]ARM:SOURce:TIMer <time>
```

<time> can be any positive floating point value from 0 (default) to 3600 (seconds) in 50 ns increments.

Example: The following command sets a 1 second arm timer.

```
ARM:SOUR:TIM 1
```

Configuring the Trigger Source

Select the trigger method using this command:

```
[CONFigure:]TRIGger:SOURce <source>
```

<source> The selected method of arming the digitizer:
IMMediate (default), SOFTware, EXTErnal, CHANnel or OR

Setting the External Trigger Signal's Slope

This command applies to the external trigger (and arm) modes only.

To specify the trigger signal's slope (the edge of the applied external trigger pulse that the digitizer will recognize), use this command:

```
[CONFigure:]EXTErnal[:INPut] <slope>
```

<slope> specifies the edge: POSitive (default) or NEGative.

Example: The following command sets a positive external trigger slope.

```
CONF:EXT:INP POS
```

Configuring Edge Trigger Attributes

To specify edge trigger attributes, use this command:

```
[CONFigure:]TRIGger:SOURce:CHANnel:EDGE  
(@<chan_list>),<level>[,<slope>[,<hysteresis>]]
```

- *<chan_list>* The channel or channels to which the edge trigger attributes apply.
- *<level>* The voltage level on the selected channel signal edge (rising or falling) which will trigger the digitizer. Specify any floating point value which satisfies the condition below.

The absolute value of *<level>*, plus *<hysteresis>*, multiplied by *<range>*, must be less than 95 percent of the channel's *<range>*.

- *<slope>* The channel signal edge that triggers the digitizer:
POSitive (default; trigger on rising edge) or
NEGative (trigger on falling edge).
- *<hysteresis>* The difference in voltage—from the specified *<level>*—required for the digitizer to recognize an edge trigger event. Specify any positive floating point value from 0.0 to 100.0, representing a percent of the channel's *<range>*. The default is 2.0.

For POSitive (rising slope) triggers, the signal must ascend across the hysteresis level below the trigger level to qualify as a trigger event.

For NEGative (falling slope) triggers, the signal must descend across the hysteresis level above the trigger level to qualify as a trigger event.

For an illustration and an example of edge triggering, see “[Channel Edge Triggering](#)” on page 116.

Configuring Window Trigger Attributes

To specify window trigger attributes, use this command:

```
[CONFigure:]TRIGger:SOURce:CHANnel:WINDow
(@<chan_list>),<level_low>,<level_high>[,<direction>
[,<hysteresis>]]
```

- **<chan_list>** The channel(s) to which the window trigger attributes apply.
- **<level_low>** The lower voltage level for the specified voltage window, used in conjunction with **<level_high>**, the specified **<direction>**, and **<hysteresis>**, to trigger the digitizer. Specify any floating point value from -95 (percent of **<range>**) to 95 (percent of **<range>**); **<level_low>** cannot exceed **<level_high>**.
- **<level_high>** The upper voltage level for the specified voltage window, used in conjunction with **<level_low>**, the specified **<direction>**, and **<hysteresis>**, to trigger the digitizer. Specify any floating point value from -95 (percent of **<range>**) to 95 (percent of **<range>**); **<level_high>** cannot be less than **<level_low>**.
- **<direction>** The transition direction that triggers the digitizer: ENTERing (default, entering the specified window) or LEAVing (leaving the specified window).
- **<hysteresis>** The difference in voltage—from the specified window between **<level_Lo>** and **<level_Hi>**—required for the digitizer to recognize a window transition trigger event. Specify any positive floating point value from 0.0 to 100.0, representing a percent of the channel's **<range>**. The default is 2.0.

For ENTERing triggers, the signal must cross the hysteresis level outside the window to qualify as a trigger event.

For LEAVing triggers, the signal must cross the hysteresis level inside the window to qualify as a trigger event.

The *Agilent L4532A/34A Command Reference* specifies limitations on the values of **<hysteresis>**, **<range>**, **<level_high>** and **<level_low>**.

For illustrations and examples of window triggering, see “[Window Triggering](#)” on page 117.

Turning Channel Triggering OFF

Channel triggering is based on channel-level events. To turn channel triggering off, use this command:

```
[CONFigure:]TRIGger:SOURce:CHANnel:OFF  
{(@<chan_list>)|ALL}
```

This command is a companion to `CONF:TRIG:SOUR:CHAN:EDGE` and `CONF:TRIG:SOUR:CHAN:WINDow`, and it is the only way to disable channel triggering once selected with either of those commands.

Specify either `(@<chan_list>)` or `ALL` (turns channel triggering off for all channels).

Example: The following command turns off channel triggering for all channels:

```
CONF:TRIG:SOUR:CHAN:OFF ALL
```

Querying Channel Trigger Mode

To query the channel trigger mode (edge, window or off) for one or more channels, use this query:

```
CONFigure:]TRIGger:SOURce:CHANnel? (@<chan_list>)
```

Example: The following query returns the channel triggering mode for all channels:

```
CONF:TRIG:SOUR:CHAN? (@1:4)
```

Typical response:

```
OFF,OFF,EDGE,WIND
```

Configuring External Trigger In/Out Connector Parameters

The rear panel **Trig In/Out** connector can be used in three ways:

- To accept an external input pulse for arming or triggering the digitizer.
- To output a pulse upon completion of an event (such as trigger accepted, acquisition completed, or record created)
- To simultaneously accept a trigger pulse and output a synchronizing pulse when multiple digitizers are configured as a single synchronous digitizer for high channel count applications.

NOTE

Each combination of settings for [CONFigure:]EXTErnal[:INPut]and [CONFigure:]EXTErnal:TRIGger:OUTPut results in a different internal digitizer configuration, creating an equivalent circuit with different input and output termination impedances. It is very important that you take these impedances into account when configuring your test circuit. See [page 156](#) for a complete explanation.

Connector Pulse Specifications

Input Pulses As an input, the **Ext Trig In/Out** connector can be configured to detect a rising or falling edge. The minimum detectable pulse width is 200 ns, with a duty cycle of 50 percent.

The maximum allowable input (trigger) pulse voltage is 5 Vpp.

Output Pulses When configured to use the **Ext Trig In/Out** connector as a pulse source (output):

- “Acquisition Complete” events (if selected as the output trigger event) always result in an output with a 1 μ s rising pulse.
- “Trigger Accepted” and “Record Completed” events (if selected as the output trigger event) always result in a rising pulse, typically of 1 μ s duration, except if multiple records are defined and those records are short enough to require an output pulse of shorter duration than 1 μ s to avoid multiple trigger events in less than 2 μ s (1 cycle of a 1 μ s pulse with 50 percent duty cycle).

The following algorithm is used by the digitizer to set a shorter output pulse when needed, to ensure that multiple events don't occur during a single output pulse, and to ensure that output pulses have a 50 percent duty cycle:

- If the output pulse is based on an acquisition event, or the record duration is 2 μ s or more, or there is only one record, the output pulse will be 1 μ s.
- Otherwise, the digitizer will produce an output pulse of only 200 ns.

Configuring the Trigger-In Slope

This command applies to the external trigger (and arm) modes only.

To select the edge (positive or negative) of the applied external pulse that will arm or trigger the digitizer, use this command:

```
[CONFigure:]EXTErnal[:INPut] <slope>
```

See “[Setting the External Arm Signal’s Slope](#)” on page 149 or “[Setting the External Trigger Signal’s Slope](#)” on page 150, for complete syntax and examples.

Configuring the Trigger-Out Attributes

To select the event that causes an output pulse and the associated impedance (on the **Trig In/Out** connector), use this command:

```
[CONFigure:]EXTErnal:TRIGger:OUTPut <event>[,<drive_mode>]
```

- *<event>* The completion event (trigger accepted, acquisition completed, record created, none) that causes an output trigger pulse: TRIGger, RECOrd, ACQuisition or NONE (default).
- *<drive_mode>* The drive mode for the external trigger bus: NEG_50, POS_50, POS_25_W_OR or OFF (default).

NEG_50 specifies a negative TTL logic drive mode, capable of driving a 50 Ω impedance bus. The inactive state provides a 50 Ω drive to logic high.

POS_50 specifies a positive TTL logic drive capable of driving a 50 Ω impedance bus. The inactive state provides a 50 Ω drive to logic low, suitable for termination of wired-OR trigger bus operation.

POS_25_W_OR specifies wired-OR trigger bus use (positive logic only). When inactive (not driving a trigger), the bus is held in a high impedance state, allowing that digitizer to recognize external trigger events configured by [CONFigure:]EXTErnal:TRIGger:INPut. When active (issuing a trigger pulse) the bus provides a positive TTL logic pulse capable of driving a 25 Ω load. Upon completion of that output pulse, the drive returns to high impedance, tri-state mode; the wired-OR bus is responsible for the falling edge.

OFF specifies high-impedance output behavior.

Example: The following command sets the digitizer to output a positive pulse (at the **Trig In/Out** connector) capable of driving a 50 Ω impedance bus, when it receives a trigger. When driving the trigger bus, the bus is pulled to logic low.

```
CONF:EXT:TRIG:OUTP TRIG,POS_50
```

Equivalent Circuits Resulting from Configuring the Trig In/Out Connector

Below is a summary of the five allowable configuration settings you might make when using the Trig In/Out connector as an arm or trigger pulse input (these cases do not apply when the connector is used to *source* a trigger). Each creates a different internal digitizer configuration, with different resulting impedances.

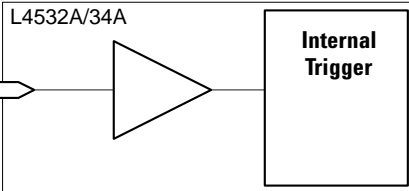
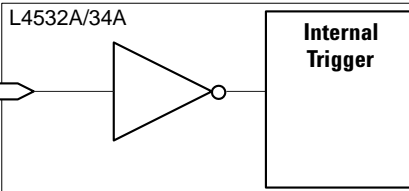
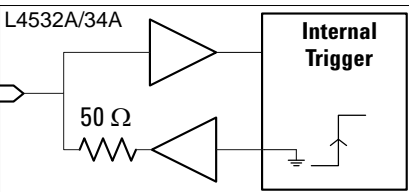
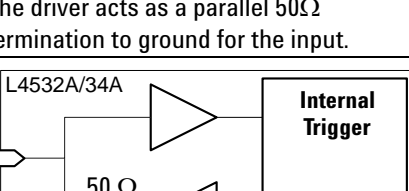
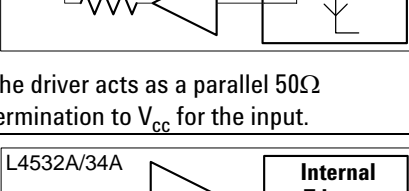
Case	Input Setting <slope>	Output Setting <event>, <drive_mode>	Input Termination	Output Termination	Equivalent Circuit, Notes
1	Positive	None	High-Z	None	
	Commands: CONF:EXT:INP POS CONF:EXT:TRIG:OUTP NONE,OFF				
2	Negative	None	High-Z	None	
	Commands: CONF:EXT:INP NEG CONF:EXT:TRIG:OUTP NONE,OFF				
3	Positive	Positive, 50 Ω	50 Ω	50 Ω	 <p>The driver acts as a parallel 50Ω termination to ground for the input.</p>
	Commands: CONF:EXT:INP POS CONF:EXT:TRIG:OUTP NONE,POS_50				
4	Negative	Negative, 50 Ω	50 Ω	50 Ωe	 <p>The driver acts as a parallel 50Ω termination to V_{cc} for the input.</p>
	Commands: CONF:EXT:INP POS CONF:EXT:TRIG:OUTP NONE,NEG_50				
5	Positive	Positive, 25Ω Wired-Or	High-Z	25 Ω	 <p>The driver is in a high-impedance state except when sourcing a trigger; then it will drive out with a 25Ω termination.</p>
	Commands: CONF:EXT:INP POS CONF:EXT:TRIG:OUTP POS_25_W_OR				

Configuring Trigger Timestamp Mode

To specify how the digitizer's timestamp counter is reset to zero, use this command:

```
[CONFigure:]TRIGger:TIMEstamp[:MODE] <counter_mode>
```

Each record's timestamp indicates when the trigger for sampling the data in that record occurred.

<counter_mode> is a required parameter. You must choose between two discrete values (INITiate or CONTinuous). The power-on/reset value is INITiate.

- If you select INITiate, the timestamp counter is zeroed with each INITiate command.
- If you select CONTinuous, the timestamp counter is reset:
 - When the [CONFigure:]TRIGger:TIMEstamp CONTinuous command is issued.
 - When you issue a SYSTem:SYNChronize:EXTernal command (with the trigger bus properly configured for multiple-digitizer synchronization).

In either case, the timestamp counter is always zeroed when power is cycled or after issuing a *RST command.

Use When: Set to CONTinuous when synchronizing multiple digitizers. This synchronizes their counters when they receive a sync pulse, and keeps their counters synchronized during acquisition.

Use With: The <init_timestamp> value returned with an acquisition preamble indicates the time in seconds from a zero reference (when the digitizers were synchronized) to the INITiate command which begins data acquisition. Together with the records timestamps, this feature allows you to determine when each sample was taken from a common reference.

Example: The following command resets the timestamp counter, and prevents it from being zeroed by the INITiate command.

```
CONF:TRIG:TIM:MODE CONT
```

Acquiring and Transferring Data

Once you have configured all needed acquisition and channel parameters, arming and triggering source parameters, and return data formats, you're ready to acquire and transfer data.

This section outlines the process for acquiring and fetching data, with detailed guidance for using the FETCh and READ command subsystems.

Overview of Simplified Data Acquisition

Using default settings, acquiring and transferring data can be as easy as issuing the command sequence:

```
INITiate
FETCh:WAVEform:ADC? (@<chan_list>
```

Once records are written to sample memory, you can repeatedly retrieve sample data and preamble data as needed using the FETCh queries. The data from the last acquisition remains in sample memory until you send the next INITiate command, send a *RST command, cycle power, or change configuration settings creating stale data.

The INITiate command clears all data from sample memory. You can also clear sample memory by issuing either of the two READ queries (READ:WAVEform:ADC? or READ:WAVEform:VOLTage?), which issue an INITiate command to begin a new acquisition.

Overview of Comprehensive Data Acquisition

With a more complex configuration, you will typically have a program development and validation phase, in which you may perform any or all of these steps:

- configure the digitizer,
- acquire data,
- fetch acquisition and record preamble (summary) information,
- check for acquisition errors,
- determine from the preambles which samples and/or records you wish to fetch,
- fetch and evaluate the data,
- reconfigure, reprogram and repeat until you achieve satisfactory results.

Once you know that your test configuration is reliable, you know which records and samples you will fetch after acquisition, and you do not expect acquisition errors, you may wish to optimize your host program for production testing.

The READ commands provide one method of streamlined testing, combining the initiate and fetch steps in one command.

The Complete Data Retrieval Process:

The process outlined below provides a typical model for retrieving sample data from the digitizer, assessing whether errors occurred in acquisition and determining what those errors were. You need not perform all steps listed here, just the ones applicable to your task.

1 Acquire data.

Upon normal acquisition completion, the digitizer will evaluate any installed measurements, then return to the Idle state. Upon an aborted acquisition process, the digitizer will return to the Idle state; some records may have been written. The digitizer must be in either the On-Board Measurements state or the Idle state to retrieve data. otherwise it will pend the FETCh or READ query until other operations are complete.

2 You may verify that data is available for fetching by issuing this query:

```
STATus:OPERation:CONDition? MTHReshold
```

- a If that query returns a 1, data is available.
- b If you believe the acquisition process has stopped or is taking too long, you may force the digitizer to return to Idle by issuing the ABORt command.

3 From the Idle state, you may retrieve the acquisition preamble by issuing this query:

```
FETCh:WAVeform:ACQuisition:PREAmble?
```

This query provides summary information on the acquisition process (see “[Acquisition Data Overview Retrieval](#)” on page 164 for complete details on using this command). Take note of the returned values from the query, to determine how to proceed with retrieving data.

- a If *<channels_with_error>* = 0, no errors occurred during acquisition; proceed with Step **3.b**. Otherwise, proceed to Step **4**.
- b If *<completion_status>* = NORM, the acquisition terminated normally. You can retrieve all data you configured the digitizer to acquire; proceed to Step **5** to retrieve the data.
- c If *<completion_status>* = ABOR, the acquisition process was aborted. You may retrieve all records before the *<last_record_sample_count_completed>*, because these records should be full as configured. Then for the last record completed (likely a partial record), you may retrieve all samples up to the *<last_record_samples_completed>*. Proceed to Step **5** to retrieve the data.
- d If *<completion_status>* = NONE, no data was acquired. Attempting to retrieve data will generate an error.

- 4 To determine which acquisition errors occurred, follow the process below:

- a From Step 3, you made note of the values of `<channels_with_error>`, `<first_record_with_error>` and `<last_record_completed>`.

The value of `<channels_with_error>` is a bit sum, including 1 if channel one had an error, 2 if channel two had an error, 4 if channel three had an error, and 8 if channel four had an error. Determine from the sum which channels had an acquisition error.

- b For each channel with an acquisition error, send the following query to return the error information:

```
FETCH:WAVEform:CHANnel:ERRor? <channel>,<record>
```

For each channel, you must send this query once for each record, from `<first_record_with_error>` to `<last_record_completed>`. See [page 166](#) for a complete description of this query.

Troubleshoot the cause of the acquisition errors as appropriate.

- 5 Before you send a FETCH or READ command to retrieve sample data, you may need to know the precise number of pre-trigger and post-trigger samples in a given record. That information will allow you to specify `<start>` and `<count>` for Step 6. You may retrieve a record preamble by issuing this query:

```
FETCH:WAVEform:RECORD:PREamble? <rec_num>
```

That query provides a record-specific summary (see [“Record-Specific Data Overview Retrieval”](#) on page 165 for complete details on using this query). Take note of the returned values from the query, to determine how to proceed when retrieving data.

- 6 Retrieve the required sample data.

- a To retrieve sample data as directed in Steps 3.b and 3.c, you may use either of the queries listed below.

```
FETCH:WAVEform:ADC? (see page 162)
```

```
FETCH:WAVEform:VOLTage? (see page 163)
```

- b To retrieve record timestamps, send the query below. Each record's timestamp allows you to know the offset from INITiate to that record's sample 0, assuming `<counter_mode>` = INITiate.

```
FETCH:WAVEform:RECORD:TIMestamps? (see page 165)
```

- c If `<counter_mode>` = CONTinuous, you must subtract a given record's timestamp from the `<init_timestamp>` (returned by the acquisition preamble query, to get the time from INITiate to sample 0.

Retrieving Sample Data Using the FETCh Queries

The FETCh command subsystem includes six queries:

- The FETCh:WAVEform:ADC? query retrieves digitized samples from memory as analog-to-digital conversion (ADC) Codes, in integer or ASCII formats (see [“Retrieving Sample Data as ADC Codes”](#) on page 162).
- The FETCh:WAVEform:VOLTage? query retrieves digitized samples from memory as voltage levels, in floating-point or ASCII formats (see [“Retrieving Sample Data as Voltage Levels”](#) on page 163).
- The FETCh:WAVEform:ACQuisition:PREamble? query returns an overview of all acquisition data currently in sample memory (see [“Acquisition Data Overview Retrieval”](#) on page 164).
- The FETCh:WAVEform:RECOrd:PREamble? query returns a data overview for a specific record currently in sample memory (see [“Record-Specific Data Overview Retrieval”](#) on page 165).
- The FETCh:WAVEform:RECOrd:TIMestamps? query returns a summary of all record timestamps for the data currently in sample memory (see [“Record Timestamp Retrieval”](#) on page 165).
- The FETCh:WAVEform:CHANnel:ERRor? query determines whether there were any acquisition errors on a specific channel, and returns stored codes and descriptions of the errors (see [“Acquisition Error Retrieval”](#) on page 166).

Retrieving Sample Data as ADC Codes

To retrieve digitized data representing ADC codes, use this query:

```
FETCh:WAVEform:ADC? (@<chan_list>), [<start>], [<count>
[, <recRange> [, <decType> [, <decCount>]]]]]
```

- *<chan_list>* The channel(s) from which data samples will be retrieved. You may specify a single channel, a comma-separated list of channels in ascending order, or a range of channels in ascending order. You may specify one, two or four channels, but not three.

Valid examples of (*@<chan_list>*) are:

- (*@2*) applies to channel 2 only
- (*@1,4*) applies to channels 1 and 4
- (*@1:4*) applies to channels 1 through 4

If you need to fetch data from three channels, it will probably be easiest to specify all four channels in a single FETCh query, then just use the returned results from the required three channels. Alternately, if the total amount of data being returned is large, you can send two separate FETCh queries; you would specify the first two channels with one query and the third channel with a second query.

- *<start>* The first sample value to fetch from the record. Specify any integer with the following restrictions. Negative *<start>* values refer to pre-trigger samples; the absolute value of a negative *<start>* cannot exceed the number of pre-trigger samples. Similarly, positive *<start>* values cannot exceed the number of post-trigger samples. The default is the first sample in the record.
- *<count>* The number of samples to fetch from the record. Specify any unsigned integer, provided that *<count>* does not exceed the number of samples in a record. The default is the number of samples in the record.
- *<recRange>* The record(s) to retrieve data from. You may specify a single record or a range of records (must be in ascending order). The default is (*@1*). For example:
 - (*@100*) retrieves data from record 100
 - (*@1:1000*) retrieves data from records 1 through 1000
- *<decType>* The decimation type for the returned data: DATA (default), AVE, or MINMAX.
- *<decCount>* The decimation count for the returned data. Specify any unsigned integer from 1 (default) to *<samples_per_record>*, provided *<decCount>* does not exceed *<count>*.

Example: The following query retrieves a waveform of 1000 samples starting with the first post-trigger sample (sample 0) on channel 1.

```
FETC:WAV:ADC? (@1),0,1000
```

Retrieving Sample Data as Voltage Levels

To retrieve digitized data representing actual voltages, use this query:

```
FETCh:WAVeform:VOLTage?  
  (@<chan_list>),[<start>],[<count> [,<recRange>  
  [,<decType> [,<decCount>]]]]]
```

The allowable parameter values are exactly the same as for the FETCh:WAVeform:ADC? query (see “Retrieving Sample Data as ADC Codes” on page 162).

Example: The following query retrieves a waveform of 1000 samples starting first post-trigger sample (sample 0) on channel 1.

```
FETC:WAV:VOLT? (@1),1,1000
```

Retrieving Record Summary Information

You can query summary acquisition data for one or all records in sample memory, acquire all records' timestamps, or determine whether a specific record had any acquisition errors (and retrieve error information). These queries are discussed below.

Acquisition Data Overview Retrieval To acquire an overview of all acquisition data currently in sample memory, use this query:

```
FETCH:WAVEform:ACQuisition:PREamble?
```

The query returns a comma-delimited list of seven integer and discrete values:

- *<last_record_completed>* The number of the last record whose acquisition is complete. If no record was completely acquired, a 0 is returned.
- *<last_record_sample_count_completed>* The number of samples completed in the last record.
- *<all_records_sample_count_completed>* Total number of samples in memory (from all channels), through the last record.
- *<completion_status>* A discrete value indicating the completion status of the last trigger accepted. The potential values returned are:
 - NOINit – The digitizer has not received an INITiate command, so it is still in the Idle state and did not complete any triggered sampling.
 - RUN – The digitizer is still *running* (either sampling or writing records to sample memory).
 - NORMal – The digitizer completed its last configured and triggered sample, and completed writing records to sample memory.
 - ABORt – The digitizer aborted sampling.
- *<first_record_with_error>* The number of the first record with an error. If no record has an error, a 0 is returned.
- *<channels_with_error>* The number of the channels with an error (if no record has an error, a 0 is returned). This is a bit sum, where the software adds 1 if channel 1 had an error, 2 if channel 2 had an error, 4 if channel 3 had an error, and 8 if channel 4 had an error.
- *<init_timestamp>* The time, in seconds, from the moment the counter was zeroed to the INITiate command that started acquisition.

Example: The following query returns the memory preamble, an acquisition overview of six values, for all records.

```
FETC:WAV:ACQ:PRE?
```

Typical Response: 25,500,12500,NORM,0,0

Record-Specific Data Overview Retrieval To acquire the preamble (data acquisition overview) for a specific record in sample memory), use this query:

```
FETCh:WAVeform:RECOrd:PREamble? <record>
```

The query returns a comma-delimited list of seven integer and floating-point values, providing these overview items:

- *<record_number>* The *<record>* number from 1 to 1024.
- *<samples_completed>* The number of samples stored in the *<record>*.
- *<pre_trigger_samples>* The number of pre-trigger samples stored in the *<record>*.
- *<trigger_time_stamp>* The number of seconds from INITiate to the sample 0 in the *<record>*.
- *<trigger_time_stamp_latency>* The number of seconds from the trigger event to sample 0.
- *<channels_with_error>* The number of the channels with an error (if no record has an error, a 0 is returned). This is a bit sum, where the software adds 1 if channel 1 had an error, 2 if channel 2 had an error, 4 if channel 3 had an error, and 8 if channel four had an error. For example, if channels 1, 2, and 4 had errors, *<channels_with_error>* would return a value of 11 (1+2+8).
- *<trigger_source>* An integer indicating the type of trigger used to trigger the subject record. Values can be -2 (external trigger), -1 (software trigger), 0 (immediate trigger), 1 (channel 1 trigger), 2 (channel 2 trigger), 3 (channel 3 trigger), or 4 (channel 4 trigger).

Example: The following query returns the record preamble (an acquisition data overview of six values) for record 10.

```
FETCh:WAV:REC:PRE? 10
```

Typical Response: 10,500,3,1.239295E-02,4.257693E-04,0,-1

Record Timestamp Retrieval Each record has a timestamp that indicates the time in seconds between INITiate and sample 0. To acquire a summary of all record timestamps for the data currently in sample memory, use this query:

```
FETCh:WAVeform:RECOrd:TIMestamps?
```

The query returns an IEEE 488 Definite Length Arbitrary Block including one timestamp (a IEEE 754-1985 64-bit floating-point value) for each record completed.

Example: The following query returns all record timestamps from the records in sample memory.

```
FETCh:WAV:REC:TIM?
```

Acquisition Error Retrieval To determine whether there was an acquisition error on a specific channel, and to return stored codes and description of the errors, use this query:

```
FETCH:WAVEform:CHANnel:ERRor? <channel> [,<record>]
```

- *<channel>* The specific channel for which you want error data.
- *<record>* The record number (specify a positive integer) in which to determine if an error was detected in the *<channel>*.

The query returns two values, as a comma-separated list:

- *<error_code_mask>* This is a positive integer formed by adding the value of each error. The values are:
 - 1 = Overvoltage
 - 4 = Internal Data I/O channel CRC error (could indicate static zap or a hardware failure).
 - 8 = Internal Data I/O channel framing error (could indicate a hardware failure).

For example, if an overload were detected for the target channel and record(s), *<error_code_mask>* would return a value of 1. CRC and framing errors are rare. If such errors occur after an instrument reset, run an instrument self-test (see “Self Test” on page 205).

- *<error_string>* This is a quoted ASCII string which provides an error message appropriate for the error code (if any) detected. The three potential values are:
 - Error code 0 returns “No Errors”
 - Error code 1 returns “Channel [n] error(s): Overvoltage protection activated.”
 - Error code 4 returns “Channel [n] error(s): Internal Data IO channel Framing error.”
 - Error code 8 returns “Channel [n] error(s): Internal Data IO channel Framing error.”

If there are multiple errors, the error messages will be listed in ascending numerical order in a single quoted ASCII string.

Example: The following query determines that there was an acquisition error on channel 3 for the tenth record and the stated cause was an overvoltage:

```
FETCH:WAV:CHAN:ERR? (@3),10
```

Typical response:

```
10,“Channel 3 error(s): Overvoltage protection activated.”
```

Retrieving Sample Data Using the READ Queries

The READ queries work exactly like their FETCh query counterparts (see “Retrieving Sample Data Using the FETCh Queries” on page 161), but begin by sending an INITiate command. The READ commands are provided as a convenient programming shorthand, so that in production testing (with arming and triggering under automated control) a single command can initiate acquisition and return data.

The allowable parameter options and return values are identical between FETCh and READ. The only difference is that in the two queries listed below, the keyword READ is substituted for FETCh.

Use When: Use a READ query instead of its equivalent FETCh query when you are sure your acquisition will complete without an error, and when you wish to maximize data throughput speed.

Example: A test can be as short as 8 samples * 1/20,000,000 sec per sample = 400 ns. If we allow 1 ms (LAN latency) each for sending the INIT and FETCh commands, the total time to acquire and return data will be over 2 ms. The majority of time is spent in LAN communication, not processing. However, using a READ query, we only send one command and can cut our total time in half. So for short acquisitions, in production using READ can speed throughput.

How to Specify: The READ command subsystem includes two queries.

- The READ:WAVEform:ADC? query retrieves digitized samples from memory representing ADC codes, in ASCII or integer formats. The complete command syntax for the READ equivalent is:

```
READ:WAVEform:ADC? (@<chan_list>),[<start>],[<count>
[,<recRange> [,<decType> [,<decCount>]]]]]
```

The FETCh query equivalent is covered in detail in “Retrieving Sample Data as ADC Codes” on page 162).

- The READ:WAVEform:VOLTage? query retrieves digitized samples from memory as voltage levels, in ASCII or floating-point formats. The complete command syntax is:

```
READ:WAVEform:VOLTage? (@<chan_list>),[<start>],[<count>
[,<recRange> [,<decType> [,<decCount>]]]]]
```

The FETCh query equivalent is covered in detail in “Retrieving Sample Data as Voltage Levels” on page 163).

Synchronizing Multiple Digitizers

For test applications where you need to simultaneously sample more inputs than the number you have on your digitizer, you may synchronize multiple digitizers so that they are phase-locked and frequency-locked. They will sample based on a common clock (using a coordinated reset of their timestamp counters), and can be treated as one contiguous high-channel-count digitizer.

The **10 MHz In** and **10 MHz Out** BNC connectors provide a internal clock reference and a means of providing time synchronization between digitizers. The **Trig In/Out** BNC connectors provide the trigger bus through which the synchronizing pulse is sent.

The third example in [Chapter 3](#), “Practical Use Examples”, provides an example of using four synchronized digitizers. It introduces the `SYSTEM:SYNChronize:EXternal` command, the use of continuous timestamp mode and some of the configuration and programming steps to implement synchronized sampling.

Many possible applications of synchronous sampling are possible, depending on the requirements of your DUT and other test instrumentation. Consult your Agilent Field Representative or the Agilent website at www.agilent.com/find/L4534A for the latest information on these applications.

Making On-Board Measurements

The L4532A/34A has considerable on-board processing power, available to provide on-board measurement capability. These on-board measurements can help characterize the signals or waveforms you digitize. This section provides detailed instructions on using these on-board measurements, which we first introduced in [“Sampling and Measuring Capabilities”](#) on page 3, then explored in [Chapter 3](#), “Practical Use Examples”.

The On-Board Measurements section has five subsections:

- For a brief introduction of installed versus discrete measurements, explaining why you might want to install measurements, see [“Comparing Installed and Discrete Measurements”](#) on page 170
- For a narrative that defines the available measurements, with explanations and graphical illustrations of each measurement, see [“How the L4532A/34A Derives Calculated Measurements”](#) on page 171.
- For complete command syntax instructions (with examples) for all global measurement parameters you can manually specify, see [“Manually Specifying Measurement Parameters”](#) on page 180. Global measurement parameters include waveform threshold values and the “window” of samples used for all subsequent measurements.
- For command syntax instructions for each measurement you can query, see [“Making Measurement Queries”](#) on page 187.
- For complete command syntax instructions (with examples) for installing measurements and retrieving the results, see [“Installed Measurements”](#) on page 194.

Comparing Installed and Discrete Measurements

The digitizer performs two types of measurements, installed and discrete. They are the same measurements, but differ in flexibility of use, timing and speed of execution.

Installed Measurements

Installed measurements are typically programmed before data acquisition, and are automatically evaluated for all records in an acquisition, once acquisition is complete. The results must be queried once the digitizer returns to the IDLE state. Complete instructions for using installed measurements begin on [page 194](#).

Do Install Measurements: If you routinely use a set of on-board measurements; it ensures that they are calculated efficiently. For example, if more than one measurement requires the digitizer to make the same interim calculation, installing them will cause the interim calculation to be performed only once. Total calculation time may decrease. Installing a comprehensive set of measurements also saves programming time, providing results automatically with each acquisition.

Do Not Install Measurements: if you want to obtain maximum speed of sampling and data retrieval. Installed measurements are calculated on all records, whether or not you plan to query the measurement results. This slows down overall data throughput performance. If several measurements are installed, they may require several seconds to calculate.

What Else You Should Know: Installed measurements are typically programmed before data acquisition, but can be programmed after the acquisition, then “re-run” based on the existing data in sample memory.

A set of installed measurements all must use a single measurement window and threshold settings you specify. If you change these settings, you can re-run the installed measurements based on the existing data in sample memory and the new settings.

You can install any of the available measurements but only in their standard form; you cannot install the VERBose form of a measurement query (See “[VERBose Queries](#)” on [page 72](#)).

Discrete Measurements

Discrete measurements are not programmed prior to acquisition; they are individually queried on a per-record basis, after acquisition is complete. These queries can be performed when the digitizer is in the IDLE state. You can query either the standard form or the VERBose form of any measurement. These measurements are described beginning on [page 187](#).

How the L4532A/34A Derives Calculated Measurements

The L4532A/34A digitizer performs on-board measurements using proprietary algorithms, involving statistical analysis using measurement histograms. Agilent has used these measurement algorithms for many years in the Agilent oscilloscope line.

The Measurement Histogram

A measurement histogram is a distribution of how often different voltage levels occur in the waveform data. This is done mathematically by the digitizer's processor, but a graphical histogram demonstrates the technique. A waveform and its associated histogram is shown below:

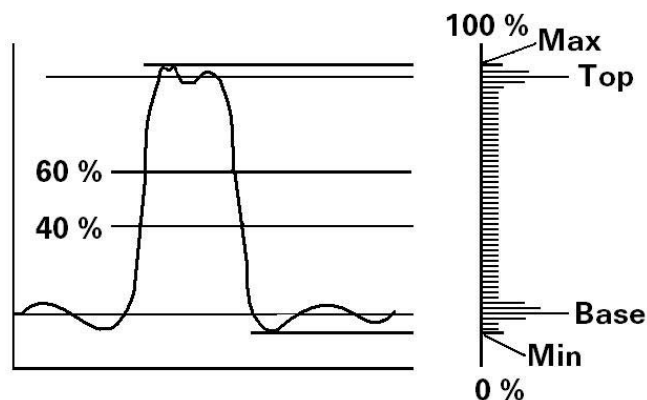

The histogram is a statistical frequency distribution bar chart, which shows the frequency of occurrence of voltage levels within the waveform.

The statistical maximum (Top) and statistical minimum (Base) levels of the waveform are found directly from the measurement histogram. The top 40 percent of the measurement histogram is scanned for the Top and the bottom 40 percent is scanned for the Base, as shown above. The center 20 percent is not scanned, which prevents selecting the middle of a tri-state waveform

The digitizer's Top and Base algorithm decides whether the Max and Min values should be used (for example, for a triangle waveform), or whether the measurement histogram peaks should be used (for example, for a square waveform). This selection technique prevents Top and Base from jumping around on waveforms with even histogram distributions (such as a triangle waveform). It also allows the detection of Top and Base for low-duty-cycle waveforms.

Measurements from the histogram algorithm are used in many of the subsequent measurements.

How Voltage Levels Are Calculated

Unless voltage (signal level) measurements are installed or queried, the digitizer does not make the calculations in this section.

The digitizer calculates its voltage level measurements as follows (note that the order of calculation may not follow the step order shown below):

- From the sample data in a given record, the absolute maximum value VMAX and absolute minimum value VMIN are determined.
- The peak-to-peak voltage amplitude VPP is calculated as the absolute value of the difference between VMAX and VMIN.
- Using the histogram algorithm, the statistical maximum value VTOP is determined; typically it represents the greatest number of data occurrences in the top 40 percent of the histogram.

From the histogram, the statistical minimum value VBASE is determined; typically it represents the greatest number of data occurrences in the bottom 40 percent of the histogram.

The digitizer's *Top and Base algorithm* decides whether the max and min values should be used, as in the case of triangle waveforms, or whether the measurement histogram peaks should be used, as in the case of square waveforms.

You may also explicitly set the VTOP and VBASE values (either as absolute voltages or percents of the selected voltage range) for the sample data, by issuing the MEASure:THResholds commands.

- The amplitude VAMplitude is calculated as the absolute value of the difference between VTOP and VBASE.

The diagram below shows the relative positions of the min and max, top and base levels for one cycle of a typical cyclic waveform, and the resulting p-p and amplitude values.

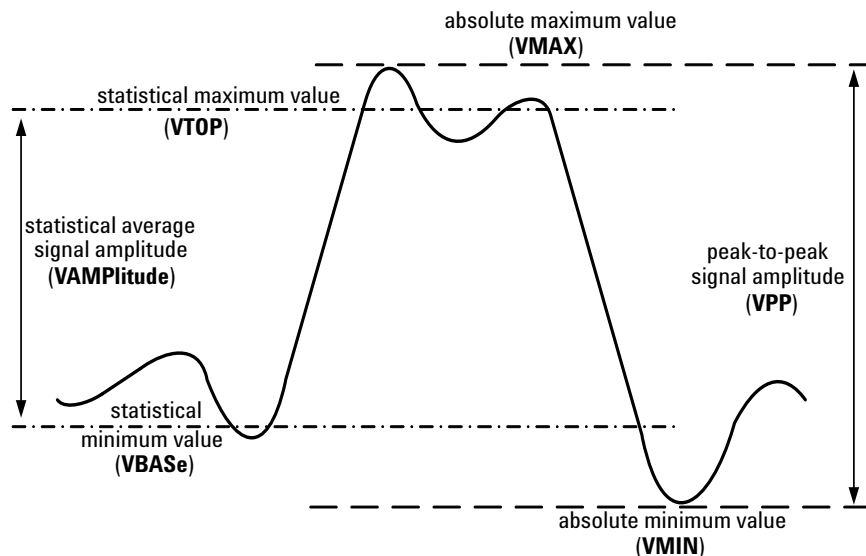

- The digitizer calculates the root-mean-square voltage value V_{RMS} as you specify, either based on an entire measurement window or for the first cycle found in the waveform.
- From the V_{TOP} and V_{BASE} values, the digitizer calculates the upper threshold level V_{UPPER} , middle threshold level V_{MIDDLE} , and lower threshold level V_{LOWER} .

You may also *explicitly* set the threshold values (either as absolute voltages or percents of the selected voltage range) for the sample data, by issuing the `MEASure:THResholds` commands.

The diagram below adds (to the previously defined min, max, top, and base levels) the threshold levels for one cycle of a typical cyclic waveform. For this illustration, the IEEE default threshold levels of 10 percent (lower), 50 percent (middle), and 90 percent (upper) were assumed.

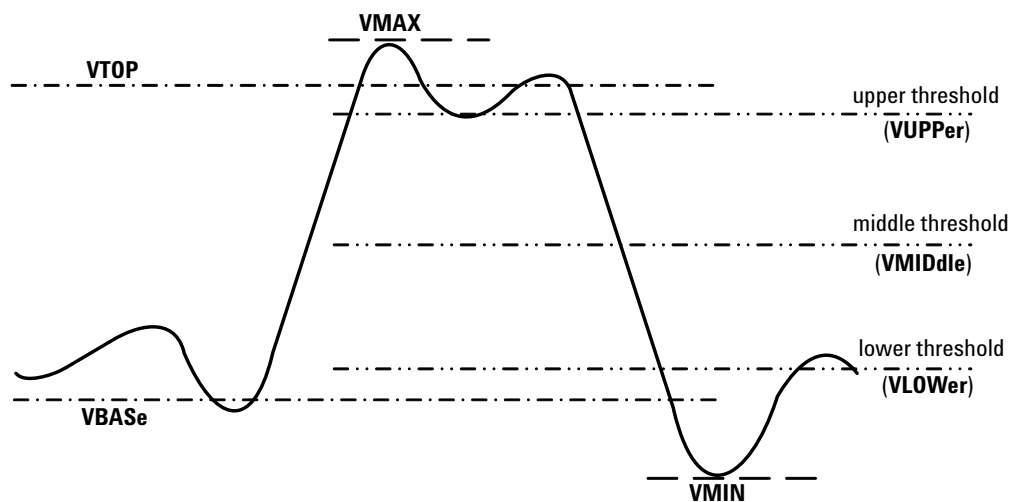

The top, base, and threshold values are used to calculate time-or-cycle-based measurements.

How Time-Based Measurements are Calculated

Unless time-based measurements are installed or queried, the digitizer does not make the subsequent calculations in this section.

The digitizer calculates its time-based measurements as follows (note that the order of calculation may not follow the step order shown here):

- Once the lower, middle, and upper threshold voltage levels have been determined, they are used to define the transition points of two signal edges; the rising edge and falling edge of the waveform.

For an edge to be present and defined, it must intersect all three (lower, middle, and upper) threshold levels. The digitizer will ignore incomplete transitions (those parts of the waveform which do not pass through all three threshold levels).

The diagram below shows the rising and falling edges for a typical cyclic waveform. As before, the IEEE default threshold levels of 10 percent (lower), 50 percent (middle), and 90 percent (upper) were assumed.

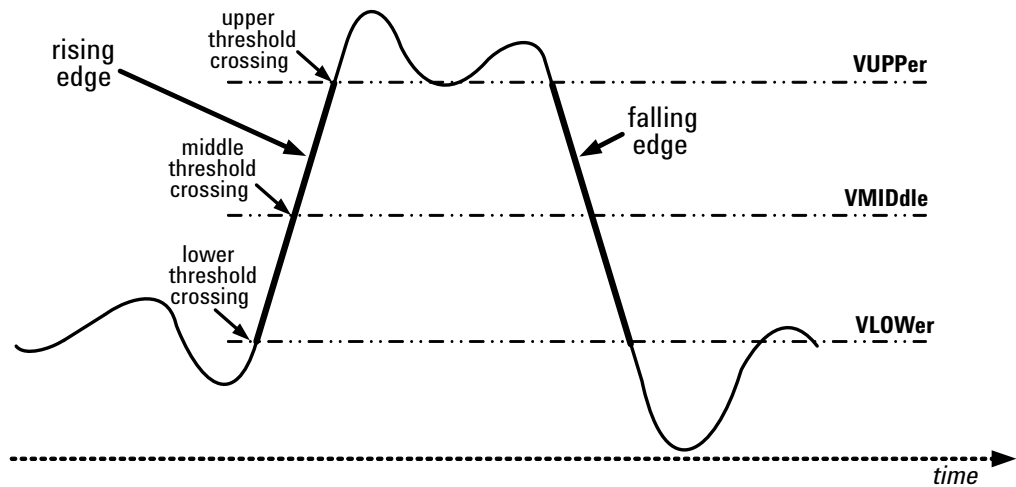

The edges and thresholds are used for calculating time-based measurements.

- Once the digitizer recognizes the mid-threshold crossing point (voltage and time) on both edges of a pulse, it can calculate pulse width. You can calculate either positive pulse width PWIDth (starts at the midpoint of a rising edge) or negative pulse width NWIDth (starts at the midpoint of a falling edge).

Below is an illustration of PWIDth.

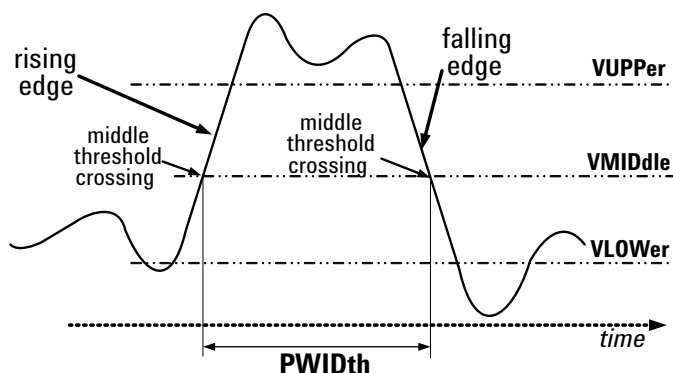

And below is an illustration of NWIDth.

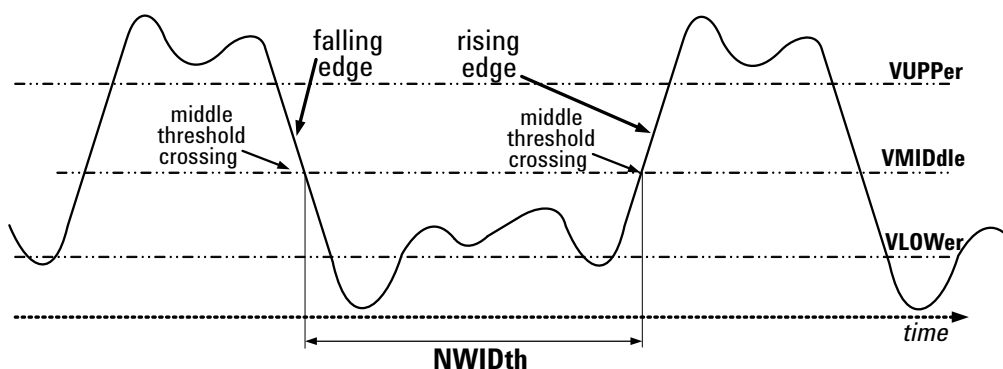

- The following measurements can also be made in either RISE or FALL mode (starting with a rising or falling edge), as illustrated on the following pages:
 - TIME (of signal rise or fall)
 - PERiod
 - FREQuency
 - DUTYcycle
 - OVERshoot
 - PRESshoot

At least one full cycle of the waveform with at least two like edges must be sampled for PERiod and FREQuency measurements; you can increase the accuracy of frequency measurements by sampling multiple pulses. For simplicity, the subsequent diagrams only show one or two pulses each.

- The RISE:TIME measurement calculates the time in seconds from the lower threshold to the upper threshold of the rising edge.

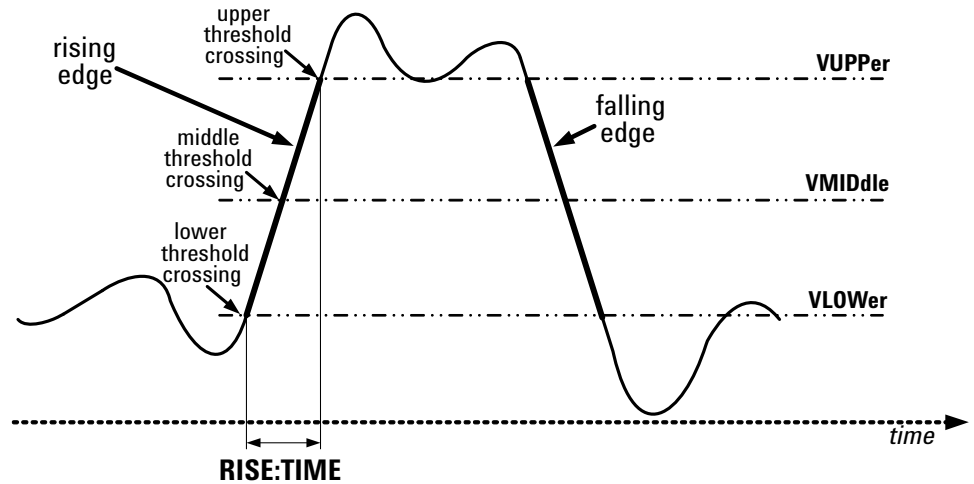

- The FALL:TIME measurement calculates the time in seconds from the upper threshold to the lower threshold of the falling edge.

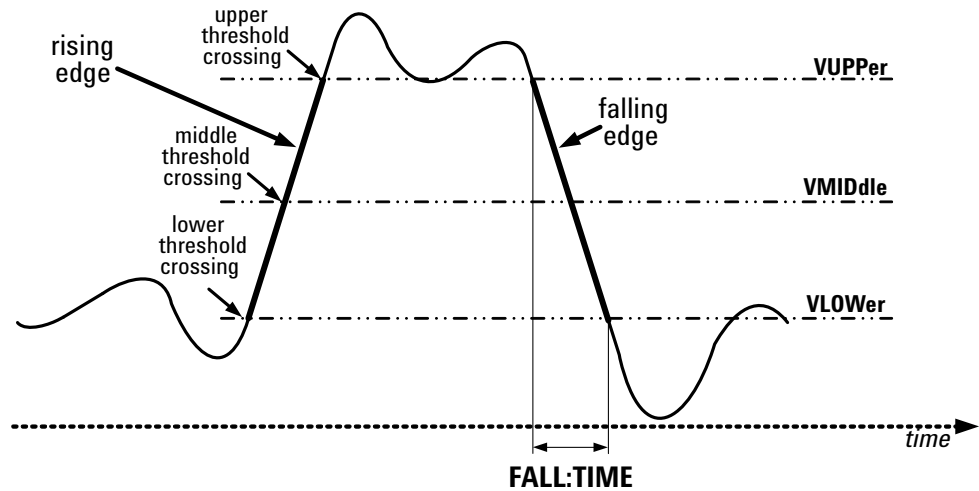

- The RISE:PERiod measurement calculates the time in seconds between subsequent mid threshold crossings of the rising edge.

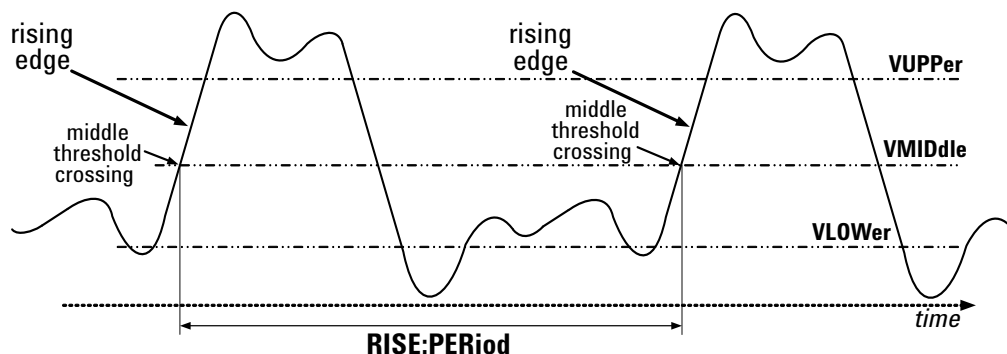

- The FALL:PERiod measurement calculates the time in seconds between subsequent mid threshold crossings of the falling edge.

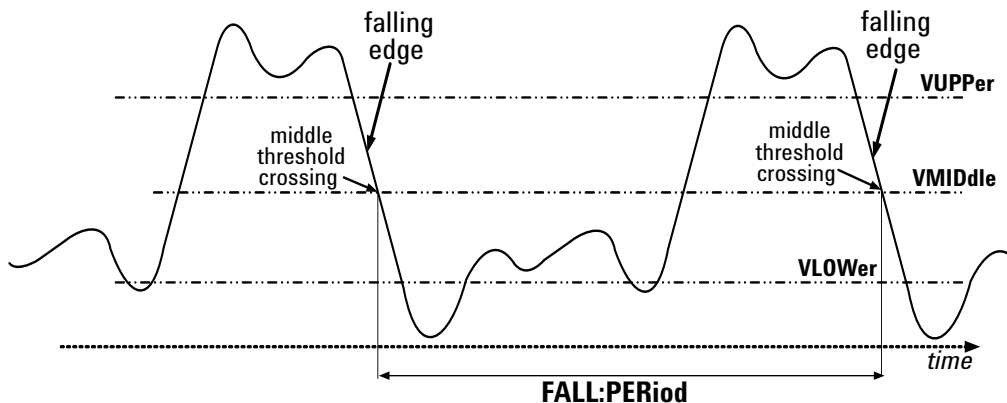

- The FREQUency measurements (in Hz) are calculated as the inverse of the period (in seconds):
 - $RISE:FREQUency = 1/RISE:PERiod$
 - $FALL:FREQUency = 1/FALL:PERiod$
- The Duty Cycle measurements (in percent) are calculated from pulse width and period, as follows.
 - $RISE:DUTYcycle = 100*(PWIDTH/RISE:PERiod)$
 - $FALL:DUTYcycle = 100*(NWIDTH/FALL:PERiod)$

- Overshoot is a distortion in signal peak following an edge.

The RISE:OVERshoot measurement calculates the amount the local maximum signal level exceeds the VTOP level of a rising edge, expressed as a percent of signal amplitude VAMP.

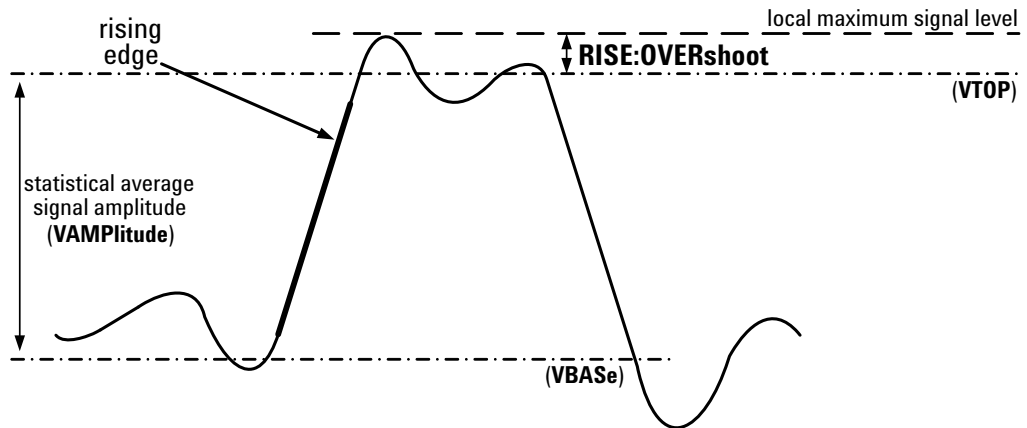

The FALL:OVERshoot measurement calculates the amount the local minimum signal level drops below the VBASE level of a falling edge, expressed as a percent of signal amplitude VAMP.

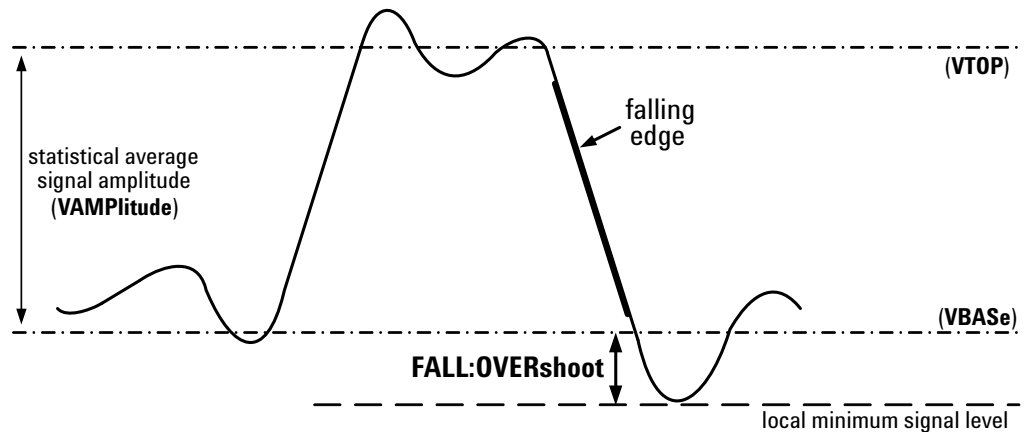

- Preshoot is a distortion in signal peak preceding an edge.

The RISE:PREShoot measurement calculates the amount the local minimum signal level drops below the VBASE level of a rising edge, expressed as a percent of signal amplitude VAMP.

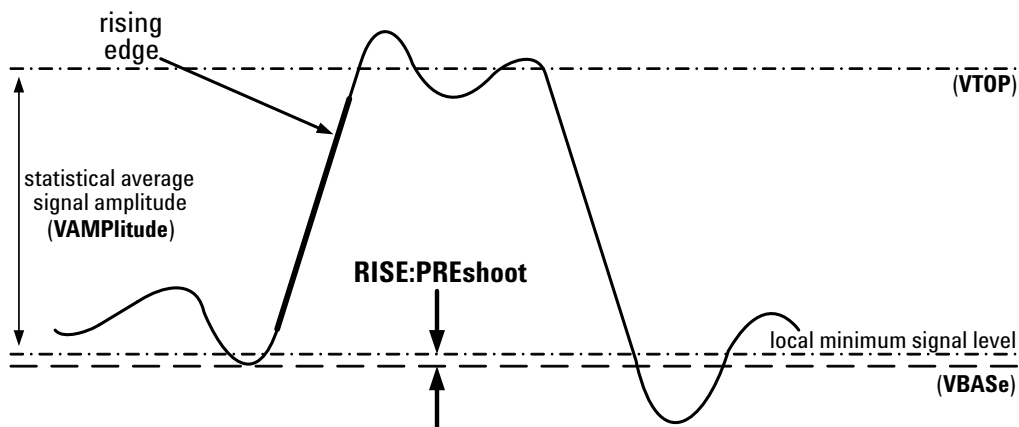

The FALL:PREShoot measurement calculates the amount the local maximum signal level exceeds the VTOP level of a falling edge, expressed as a percent of signal amplitude VAMP.

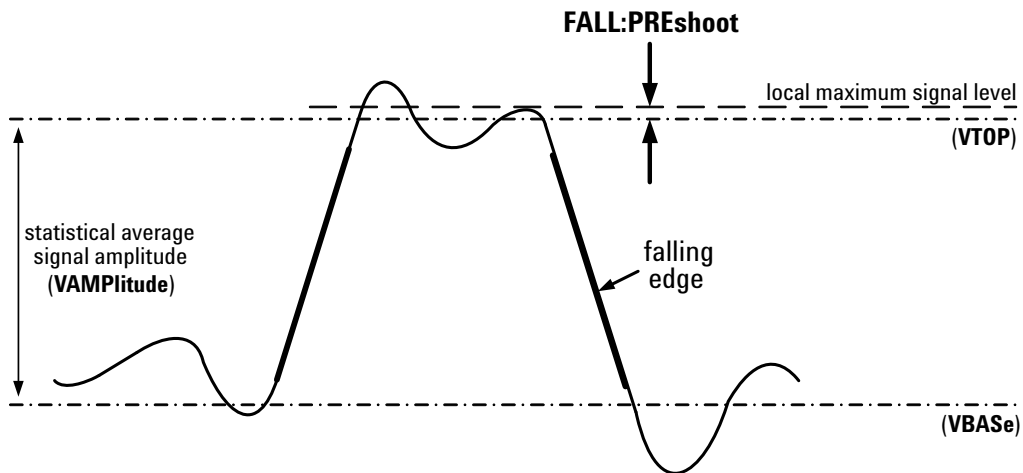

Manually Specifying Measurement Parameters

The MEASure command subsystem includes two types of commands that allow you to set parameters that apply to all subsequent measurements you make, whether discrete or installed.

- The MEASure:WINDow command allows you to define a “window” of samples within a specified record; these samples will be used to make subsequent measurements. See [“Specifying a Measurement Window”](#) on page 181 for command syntax and examples.
- The six MEASure:THReshold commands allow you to define the method by which the digitizer sets the top, base, and threshold voltage levels used to make subsequent measurements. Specifying these values overrides the power-on/reset default values. Those defaults use the digitizer’s algorithm to determine VTOP and VBASe; the thresholds VLOWer, VMIDdle, and VUPPer default to the IEEE standard 10 percent, 50 percent, and 90 percent of VAMPLitude, respectively.
 - Use the MEASure:THResholds:TOPBase:METhod command to choose between the digitizer’s algorithm (automatic setting) or absolute voltage levels you specify, to set VTOP and VBASe. See [“Selecting the Method for Setting Top and Base Levels”](#) on page 182 for command syntax and examples.

If you choose *<method>* = ABSolute, use the MEASure:THResholds:TOPBase:ABSolute command to specify these levels. See [“Specifying Absolute Top and Base Levels”](#) on page 182 for command syntax and examples.

- Use the MEASure:THResholds:METhod command to choose between PERCent (of VAMPLitude) or ABSolute voltage levels you specify, to set the thresholds VLOWer, VMIDdle, and VUPPer. See [“Selecting the Method for Setting Threshold Levels”](#) on page 183 for command syntax and examples.

If you choose *<method>* = PERCent, use the MEASure:THResholds:PERCent command to specify these levels. See [“Specifying Percentage Threshold Levels”](#) on page 184 for command syntax and examples.

If you choose *<method>* = ABSolute, use the MEASure:THResholds:ABSolute command to specify these levels. See [“Specifying Absolute Threshold Levels”](#) on page 185 for command syntax and examples.

- Use the MEASure:THResholds:RESet command to reset all five voltage levels (VTOP, VBASe, VLOWer, VMIDdle, and VUPPer) to their power on/reset values. See [“Resetting Default Top, Base and Threshold Levels”](#) on page 186 for command syntax and examples.

Specifying a Measurement Window

To define the *measurement window* (a range of samples within a record) to be used in making subsequent measurements, use this command:

```
MEASure:WINDow[:DEFine] <start_offset>, <size>
```

- *<start_offset>* The offset in samples from the first post-trigger sample to the start of the measurement window. Negative values require the window to start before the trigger reading, and positive values require the window to start after the trigger reading. A value of 0 indicates that the window should start at the trigger reading. Specify any integer, from the negative of the number of pre-trigger samples to the number of post-trigger samples minus 8. The “minus 8” accounts for the minimum window size.
- *<size>* The number of samples within the measurement window, *after* the *<start_offset>*. Specify any integer from 0 to the number of samples in the record after the *<start_offset>*.

NOTE

The power-on/reset value of *<size>* is 0, implicitly turning off all OBM. To ensure that OBM are calculated, you must send this command, with a *<size>* parameter of 8 or larger.

Example: The following command sets the measurement window to 150 samples, starting 50 samples before the trigger reading:

```
MEAS:WIND:DEF -50,150
```

The specified window applies to all measurements (discrete or installed).

Selecting the Method for Setting Top and Base Levels

To select the method the digitizer will use to set or calculate VTOP and VBASE, use this command:

```
MEASure:THResholds:TOPBase:METhod
(@<chan_list>),<method>
```

- <chan_list> The channel(s) to which the selected <method> applies.
- <method> The method the digitizer will use to set or calculate VTOP and VBASE: STANdard (default), ABSolute)

The STANdard method uses a histogram algorithm to calculate VTOP and VBASE. If it produces a statistically unsatisfactory result, it sets VTOP to VMAX and VBASE to VMIN.

The ABSolute method forces the explicit voltage levels you specify with the MEASure:THReshold:TOPBase:ABSolute command to be used for VTOP and VBASE.

Example: The following command sets the TOPBase method to STANdard on channels 1 and 2.

```
MEAS:THR:TOPB:METH (@1,2),STAN
```

Specifying Absolute Top and Base Levels

To specify voltage values for VTOP and VBASE, use this command:

```
MEASure:THResholds:TOPBase:ABSolute
(@<chan_list>),<vTop>,<vBase>
```

- <chan_list> The channel(s) to which the specified <vTop> and <vBase> levels apply.
- <vTop> The specified value for VTOP. Specify any floating point value from -256 V to +256 V, provided that <vTop> is greater than <vBase>. The minimum resolution is 0.001 V. The power-on/reset value is +1.0 V.
- <vBase> The specified value for VBASE. Specify any floating point value from -256 V to +256 V, provided that <vBase> is less than <vTop>. The minimum resolution is 0.001 V. The power-on/reset value is -1.0 V.

Example: The following command sets VTOP to 50 V and VBASE to 10 V, for channels 1 through 3.

```
MEAS:THR:TOPB:ABS (@1:3),50,10
```

Selecting the Method for Setting Threshold Levels

To specify the method the digitizer will use to set or calculate the threshold values VUPPer, VMIDdle, and VLOWer, use this command:

```
MEASure:THResholds:METhod (@<chan_list>),<method>
```

- <chan_list> The channel(s) to which the selected <method> applies.
- <method> The method the digitizer will use to set or calculate VUPPer, VMIDdle, and VLOWer: PERCent (default) or ABSolute.

The PERCent method uses percentages of VAMPLitude to calculate VUPPer, VMIDdle, and VLOWer; you specify these three percentages with the MEASure:THResholds:PERCent command.

The ABSolute method forces the voltage levels you specify with the MEASure:THResholds:ABSolute command to be used for VUPPer, VMIDdle, and VLOWer.

Example: The following command sets the threshold assessment method for channels 1 and 2 to PERCent.

```
MEAS:THR:METh (@1,2),PERC
```

Specifying Percentage Threshold Levels

To specify percentage levels for VUPPer, VMIDdle, and VLOWer, use this command:

```
MEASure:THResholds:PERcent
(@<chan_list>),<%High>,<%Mid>,<%Low>
```

The levels you specify are percentages of VAMplitude, the difference between VTOP and VBASE. The IEEE standard values (used as defaults by this digitizer) are 90 percent, 50 percent and 10 percent of the amplitude. You may override these default values to improve recognition of a rising or falling signal edge, depending on the characteristics of your test waveform.

The thresholds you specify become active only if you set the <method> parameter for the MEASure:THReshold:METHOD command to PERCent.

The MEASure:THResholds:PERcent command has four parameters:

- <chan_list> The channel(s) to which the specified percentage threshold levels apply.
- <%High> The specified percentage for VUPPer. Specify any floating-point value from 0 to 100, provided that <%High> is greater than <%Mid>. The minimum resolution is 0.1 percent. The power-on/reset value is 90.
- <%Mid> The specified percentage for VMIDdle. Specify any floating-point value from 0 to 100, provided that <%Mid> is between <%Low> and <%High>. The minimum resolution is 0.1 percent. The power-on/reset value is 50.
- <%Low> The specified percentage for VLOWer. Specify any floating-point value from 0 to 100, provided that <%Low> is less than <%Mid>. The minimum resolution is 0.1 percent. The power-on/reset value is 10.

Example: The following command sets VUPPer, VMIDdle, and VLOWer for channel 1 to 80 percent, 50 percent, and 20 percent, respectively.

```
MEAS:THR:PERC (@1),80,50,20
```

Specifying Absolute Threshold Levels

To specify voltage levels for VUPPer, VMIDdle, and VLOWer, use this command:

```
MEASure:THResholds:ABSolute  
(@<chan_list>),<vHigh>,<vMid>,<vLow>
```

The levels you specify are absolute numeric voltage levels, between the digitizer's limits of +/-256 V. The IEEE standard values (used as defaults by this digitizer) are 90 percent, 50 percent, and 10 percent of VAMPLitude, the difference between VTOP and VBASE. You may override these default values to improve recognition of a rising or falling signal edge, depending on the characteristics of your test waveform.

These explicit voltage thresholds become active only if you set the <method> parameter for the MEASure:THReshold:METHOD command to ABSolute.

The MEASure:THResholds:ABSolute command has four parameters:

- <chan_list> The channel(s) to which the specified voltage threshold levels apply.
- <vHigh> The specified voltage value for VUPPer. You may specify any floating-point value from -256 V to 256 V, provided that <vHigh> is greater than <vMid>. The minimum resolution is 0.001 V. The power-on/reset value is +1 V.
- <vMid> The specified voltage value for VMIDdle. You may specify any floating-point value from -256 V to 256 V, provided that <vMid> is between <vLow> and <vHigh>. The minimum resolution is 0.001 V. The power-on/reset value is 0 V.
- <vLow> The specified voltage value for VLOWer. You may specify any floating-point value from -256 V to 256 V, provided that <vLow> is less than <vMid>. The minimum resolution is 0.001 V. The power-on/reset value is -1 V.

Example: The following command sets VUPPer, VMIDdle, and VLOWer for channel 1 to 100 V, 50 V, and 10 V, respectively.

```
MEAS:THR:VOLT (@1),100,50,10
```

Resetting Default Top, Base and Threshold Levels

To reset one or more channels of the digitizer to the default assessment method and default values for VTOP, VBASE, VUPPER, VMIDDLE, and VLOWER, use this single command:

```
MEASure:THResholds:RESet (@<chan_list>)
```

<chan_list> identifies the channel(s) to be reset to the default assessment methods, TOPBase levels and threshold levels.

The MEASure:THResholds:RESet command is equivalent to issuing the following five commands:

```
MEASure:THResholds:METHOD <@chan_list>,PERCent
MEASure:THResholds:PERCent <@chan_list>,90,50,10
MEASure:THResholds:ABSolute <@chan_list>,1,0,-1
MEASure:THResholds:TOPBase:METHOD <@chan_list>STANdard
MEASure:THResholds:TOPBase:ABSolute <@chan_list>,1,-1
```

Example: The following command resets all TOPBase and threshold assessment methods and values to their power-on/reset states, for channel 1.

```
MEAS:THR:RES (@1)
```

Making Measurement Queries

The standard form measurement queries (discrete measurements) are presented in the order listed below, which parallels the order these measurements are defined in “How the L4532A/34A Derives Calculated Measurements” on page 171.

Voltage Level Measurements:

- VMAX (see “Calculating VMAX” on page 188).
- VMIN (see “Calculating VMIN” on page 188).
- VPP (see “Calculating VPP” on page 188).
- VTOP (see “Calculating VAMPLitude” on page 188).
- VBASe (see “Calculating VBASe” on page 188).
- VAMPLitude (see “Calculating VAMPLitude” on page 188).
- VRMS (see “Calculating VRMS” on page 189).
- VUPPer (see “The measurements VUPPer, VMIDdle, and VLOWer are used for time-based measurements, and are illustrated for a typical pulse waveform on page 173.” on page 189).
- VMIDdle (see “Calculating VMIDdle” on page 189).
- VLOWer (see “Calculating VLOWer” on page 189).
- PWIDth (see “Calculating PWIDth” on page 190).
- NWIDth (see “Calculating NWIDth” on page 190).

Time-Based Measurements:

- RISE:TIME (see “Calculating RISE:TIME” on page 190).
- FALL:TIME (see “Calculating FALL:TIME” on page 190).
- RISE:PERiod (see “Calculating RISE:PERiod” on page 191).
- FALL:PERiod (see “Calculating FALL:PERiod” on page 191).
- RISE:FREQuency (see “Calculating RISE:FREQuency” on page 191).
- FALL:FREQuency (see “Calculating FALL:FREQuency” on page 191).
- RISE:DUTYcycle (see “Calculating RISE:DUTYcycle” on page 192).
- FALL:DUTYcycle (see “Calculating FALL:DUTYcycle” on page 192).
- RISE:OVERshoot (see “Calculating RISE:OVERshoot” on page 192).
- FALL:OVERshoot (see “Calculating FALL:OVERshoot” on page 192).
- RISE:PREShoot (see “Calculating RISE:PREShoot” on page 193).
- FALL:PREShoot (see “Calculating FALL:PREShoot” on page 193).

All standard form measurement queries return a single value, calculated for the channel and record you specify (the record defaults to record #1 if unspecified). They are made only using samples within the measurement window you specify using the MEASure:WINDow:DEFine command (see “Specifying a Measurement Window” on page 181).

Each VERBoSe form measurement query returns five additional values (see “VERBoSe Queries” on page 72 for an explanation of standard and VERBoSe measurement queries).

The measurements VMAX, VMIN, VPP, VAMP, VTOP, and VBASE are illustrated for a typical pulse waveform on page 172.

These measurements all use the same parameters, and all return a value for a specific channel (1 to 4) and record (1 to 1024).

Calculating VMAX

To calculate and return the absolute maximum value, use this query:

```
MEASure:VMAX[:VERBoSe]? (@<channel>) [,<rec_num>]
```

Calculating VMIN

To calculate and return the absolute minimum value, use this query:

```
MEASure:VMIN[:VERBoSe]? (@<channel>) [,<rec_num>]
```

Calculating VPP

To calculate and return the peak-to-peak signal amplitude, use this query:

```
MEASure:VPP[:VERBoSe]? (@<channel>) [,<rec_num>]
```

Calculating VAMPLitude

To calculate and return the signal amplitude, use this query:

```
MEASure:VAMPLitude[:VERBoSe]? (@<channel>) [,<rec_num>]
```

Calculating VTOP

To return the top voltage level (used for time-based measurements), use this query:

```
MEASure:VTOP[:VERBoSe]? (@<channel>) [,<rec_num>]
```

The returned value may be calculated from the sample data or may be an absolute voltage level you previously specified by issuing the MEASure:THResholds:TOPBase:METhod and MEASure:THResholds:TOPBase:ABSolute commands.

Calculating VBASE

To return the base voltage level (used for time-based measurements), use this query:

```
MEASure:VBASE[:VERBoSe]? (@<channel>) [,<rec_num>]
```

The returned value may be calculated from the sample data or may be an absolute voltage level you previously specified by issuing the MEASure:THResholds:TOPBase:METhod and MEASure:THResholds:TOPBase:ABSolute commands.

The measurements VUPPer, VMIDdle, and VLOWer are used for time-based measurements, and are illustrated for a typical pulse waveform on [page 173](#).

These measurements all use the same parameters, and all return a value for a specific channel (1 to 4) and record (1 to 1024).

The returned value may be calculated from the sample data or may be an absolute voltage level you previously specified by issuing the MEASure:THResholds:METhod, MEASure:THResholds:ABSolute, and MEASure:THResholds:PerCent commands.

Calculating VUPPer

To return the upper threshold level, use this query:

```
MEASure:VUPPer[:VERBose]? (@<channel>) [,<rec_num>]
```

Calculating VMIDdle

To return the middle threshold level, use this query:

```
MEASure:VMIDdle[:VERBose]? (@<channel>) [,<rec_num>]
```

Calculating VLOWer

To return the lower threshold level, use this query:

```
MEASure:VLOWer[:VERBose]? (@<channel>) [,<rec_num>]
```

Calculating VRMS

To calculate and return the root-mean-square (RMS) signal amplitude, use this query:

```
MEASure:VRMS[:VERBose]?
(@<channel>)[,<mode>,<coupling>] [,<rec_num>]]
```

- *<channel>* and *<rec_num>* are specified as with the earlier measurements.
- *<mode>* The part of the measurement window used to calculate the RMS amplitude: CYCLE or WINDOW (default).

If you select *<mode>* = CYCLE, the digitizer assesses VRMS for the first complete cycle found in the measurement window, but does not allow you to discern RMS differences between subsequent cycles.

If you select *<mode>* = WINDOW, the digitizer assesses VRMS for all samples in the measurement window. For repeating cyclical waveforms, the digitizer will seldom use an integer number of cycles.

<coupling> If DC (default), the DC signal component of the waveform is included in the VRMS calculation. If AC, the DC component is subtracted from the VRMS calculation.

The measurements *PWIDTH* and *NWIDTH* are defined and illustrated for a typical pulse waveform on [page 175](#).

These measurements both return a value for a specific channel (1 to 4) and record (1 to 1024).

Calculating PWIDTH

To calculate and return the positive pulse width, use this query:

```
MEASure:PWIDth[:VERBoSe]?
(@<channel>)[,<num_pos_pulse>[,<rec_num>]]
```

- *<num_pos_pulse>* The number of the positive pulse on which the queried measurement should be performed. You may specify any positive integer value. The default value is 1.

Calculating NWIDTH

To calculate and return the negative pulse width, use this query:

```
MEASure:NWIDth[:VERBoSe]?
(@<channel>)[,<num_neg_pulse>[,<rec_num>]]
```

- *<num_neg_pulse>* The number of the negative pulse on which the queried measurement should be performed. You may specify any positive integer. The default value is 1.

The measurements *RISE:TIME* and *FALL:TIME* are defined and illustrated for a typical pulse waveform on [page 176](#).

These measurements both return a value for a specific channel (1 to 4) and record (1 to 1024).

Calculating RISE:TIME

To calculate and return the waveform's rise time, use this query:

```
MEASure:RISE:TIME[:VERBoSe]?
(@<channel>)[,<num_edge>[,<rec_num>]]
```

- *<num_edge>* The number of the rising edge on which the queried rise time measurement should begin. You may specify any positive integer. The default value is 1.

Calculating FALL:TIME

To calculate and return the waveform's fall time, use this query:

```
MEASure:FALL:TIME[:VERBoSe]?
(@<channel>)[,<num_edge>[,<rec_num>]]
```

- *<num_edge>* The number of the falling edge on which the queried fall time measurement should begin. You may specify any positive integer. The default value is 1.

The measurements RISE:PERiod and FALL:PERiod are defined and illustrated for a typical pulse waveform on page 177.

These measurements both return a value for a specific channel (1 to 4) and record (1 to 1024).

Calculating RISE:PERiod

To calculate and return the waveform's period beginning on a rising edge, use this query:

```
MEASure:RISE:PERiod[:VERBose]?
(@<channel>)[,<num_edge>[,<rec_num>]]
```

- *<num_edge>* The number of the rising edge on which the queried period measurement should begin. You may specify any positive integer. The default value is 1.

Calculating FALL:PERiod

To calculate and return the waveform's falling period beginning on a falling edge, use this query:

```
MEASure:FALL:PERiod[:VERBose]?
(@<channel>)[,<num_edge>[,<rec_num>]]
```

- *<num_edge>* The number of the falling edge on which the queried period measurement should begin. You may specify any positive integer. The default value is 1.

The measurements RISE:FREQuency and FALL:FREQuency are defined for a typical pulse waveform on page 177.

These measurements both return a value for a specific channel (1 to 4) and record (1 to 1024).

Calculating RISE:FREQuency

To calculate and return the waveform's rising frequency beginning on a rising edge, use this query:

```
MEASure:RISE:FREQuency[:VERBose]?
(@<channel>)[,<num_edge>[,<rec_num>]]
```

- *<num_edge>* The number of the rising edge on which the queried frequency measurement should begin. You may specify any positive integer. The default value is 1.

Calculating FALL:FREQuency

To calculate and return the waveform's falling frequency beginning on a falling edge, use this query:

```
MEASure:FALL:FREQuency[:VERBose]?
(@<channel>)[,<num_edge>[,<rec_num>]]
```

- *<num_edge>* The number of the falling edge on which the queried frequency measurement should begin. You may specify any positive integer. The default value is 1.

The measurements RISE:DUTYcycle and FALL:DUTYcycle are defined for a typical pulse waveform on page 177.

These measurements both return a value for a specific channel (1 to 4) and record (1 to 1024).

Calculating RISE:DUTYcycle

To calculate and return the waveform's duty cycle beginning on a rising edge, use this query:

```
MEASure:RISE:DUTYcycle[:VERBose]?
(@<channel>)[,<num_edge>[,<rec_num>]]
```

- *<num_edge>* The number of the rising edge on which the queried duty cycle measurement should begin. You may specify any positive integer. The default value is 1.

Calculating FALL:DUTYcycle

To calculate and return the waveform's duty cycle beginning on a falling edge, use this query:

```
MEASure:FALL:DUTYcycle[:VERBose]?
(@<channel>)[,<num_edge>[,<rec_num>]]
```

- *<num_edge>* The number of the falling edge on which the queried duty cycle measurement should begin. You may specify any positive integer. The default value is 1.

The measurements RISE:OVERshoot and FALL:OVERshoot are defined for a typical pulse waveform on page 178.

These measurements both return a value for a specific channel (1 to 4) and record (1 to 1024).

Calculating RISE:OVERshoot

To calculate and return the waveform's overshoot beginning on a rising edge, use this query:

```
MEASure:RISE:OVERshoot[:VERBose]?
(@<channel>)[,<num_edge>[,<rec_num>]]
```

- *<num_edge>* The number of the rising edge on which the queried overshoot measurement should be performed. You may specify any positive integer. The default value is 1.

Calculating FALL:OVERshoot

To calculate and return the waveform's overshoot beginning on a falling edge, use this query:

```
MEASure:FALL:OVERshoot[:VERBose]?
(@<channel>)[,<num_edge>[,<rec_num>]]
```

- *<num_edge>* The number of the falling edge on which the queried overshoot measurement should be performed. You may specify any positive integer. The default value is 1.

The measurements RISE:PREshoot and FALL:PREshoot are defined for a typical pulse waveform on [page 178](#).

These measurements both return a value for a specific channel (1 to 4) and record (1 to 1024).

Calculating RISE:PREshoot

The measurement RISE:PREshoot is defined for a typical pulse waveform on [page 178](#).

To calculate and return the waveform's preshoot beginning on a rising edge, use this query:

```
MEASure:RISE:PREshoot[:VERBose]?  
(@<channel>)[,<num_edge>[,<rec_num>]]
```

- *<num_edge>* The number of the rising edge on which the queried preshoot measurement should be performed. You may specify any positive integer. The default value is 1.

Calculating FALL:PREshoot

To calculate and return the waveform's preshoot beginning on a falling edge, use this query:

```
MEASure:FALL:PREshoot[:VERBose]?  
(@<channel>)[,<num_edge>[,<rec_num>]]
```

- *<num_edge>* The number of the falling edge on which the queried preshoot measurement should be performed. You may specify any positive integer. The default value is 1.

Installed Measurements

Defining an Installed Measurement

To install a measurement and give it a symbolic label, use this command:

```
MEASure:INSTall:DEFine <label>,<meas_string>
```

You may install up to 20 measurements.

<label> The name you choose to label a specific installed measurement. Specify any ASCII string from 1 to 12 characters, with the following restrictions: The first character must be a letter (A-Z), but the remaining 11 characters can be letters, numbers (0-9), or underscore (_). Blank spaces are not allowed.

<meas_string> A quoted string containing a discrete MEASure command with its associated parameters (except <rec_num>; installed measurements apply to all records). The quoted string must follow the syntax requirements for the specified command. The VERbose forms of measurement commands are not allowed. Some examples are:

"MEAS:PWID? (@2),5" specifies a command to measure pulse width for all records on channel 2, positive pulse #5.

"MEASure:FALL:TIME? (@1),4" specifies a command to measure fall time for all records on channel 1, falling edge of pulse #4.

"MEASure:VAMP? (@3)" specifies a command to measure amplitude for all records on channel 3.

Example: The following command installs a command labeled MEZPW25, which will measure the pulse width from all records on channel 2, positive pulse #5.

```
MEAS:INST:DEF MEZPW25,"MEAS:PWID? (@2),5"
```

You may not install a duplicate measurement (the same measurement but with a different label); it generates an error.

Example: The following set of commands are not allowed.

```
MEAS:INST:DEF VAMP1,"MEAS:VAMP? (@1)" this gets installed
MEAS:INST:DEF VAMP2,"MEAS:VAMP? (@1)" this generates an error
```

You may redefine an installed measurement (a new measurement using an existing label); it does not generate an error.

Example: The following set of commands are allowed.

```
MEAS:INST:DEF VAMP1,"MEAS:VAMP? (@1)" original measurement
MEAS:INST:DEF VAMP1,"MEAS:VAMP? (@2)" revised measurement
```

Querying the Results of Installed Measurements

To obtain the results from one or all installed measurements, use this query:

```
MEASure:INSTall:RESults[:RECORD]? [{<label>|ALL}  
[, {<record_num>|ALL}]]
```

<label> is the name of the installed measurement you want results from (see [page 194](#)). You may specify ALL instead of the *<label>* parameter, to return results from all installed measurements. If the value you enter for *<label>* is not recognized as an installed measurement, the digitizer will return an error message.

<record_num> is the specific record you want results from. You may specify ALL instead of the *<record_num>* parameter, to return results from all records.

For each record specified, the results are returned in alphabetical order of the measurement(s)'s label(s), not in the order installed. If all records are specified, the data is returned in ascending record order, beginning with record 1.

The format of the returned data is specified by the `FORMat[:DATA:]REAL` command. If you specified REAL 32 or REAL 64 format, the query returns an IEEE 488 Definite Length Arbitrary Block (see [page 131](#) or [page 132](#)). If you specified ASCII format, the query returns a comma delimited list (see [page 133](#)). The byte order of the data in this block is returned as specified by the `FORMat:BORDER` command. (see [page 134](#)).

Example: The following query returns the values of all (three in this example) currently installed measurements.

```
MEAS:INST:RES? ALL
```

Typical Response:

```
3.215282E-04,2.781955E-03,8.838381E+00
```

Example: The following query returns the values of the installed measurement labeled VRMS2.

```
MEAS:INST:RES? VRMS2
```

Typical Response:

```
3.215282E-04
```

For a description of the results of the verbose query form, see the *Agilent L4532A/34A Command Reference*.

Listing Installed Measurements by Label To acquire a “catalog” list of labels for all currently installed measurements, use this query:

```
MEASure:INSTall:CATalog?
```

This query has no parameters. It returns a comma-delimited list, including each installed measurement’s label as a quoted string. The labels are returned in alphabetical order, not in the order installed.

Example: The following query returns a list of all currently installed measurements.

```
MEAS:INST:CAT?
```

Typical Response: “VAMP3,VAMP4,PWID25”

Deleting an Installed Measurement

To delete an installed measurement, use this command:

```
MEASure:INSTall:DElete {<label>|ALL}
```

<label> is the name of the installed measurement you wish to delete (see [page 194](#)).

If the value you enter for <label> is not recognized as an installed measurement, the digitizer will return an error message. You may specify ALL instead of the <label> parameter, to delete all installed measurements.

Example: The following command deletes the installed command labeled MEZPW25.

```
MEAS:INST:DEL MEZPW25
```

Example: The following command deletes all installed measurements.

```
MEAS:INST:DEL ALL
```

Re-Running Installed Measurements

To re-run a set of installed measurements using the existing acquisition data in sample memory, after making changes to the measurement window or threshold settings, use this command:

```
MEASure:INSTall:RUN
```

If you change the measurement window or thresholds, and do not re-run the measurements, you will get a stale data error upon querying the results (see “[Stale Data Errors](#)” on [page 74](#)).

System-Related Operations

The L4532A/34A digitizers provide several features to help you assess and control the instrument's operating conditions.

- You can save and recall configured instrument states, including all parameters stored in volatile memory (see “[Configured Instrument States](#)” on page 198).
- You can display custom text on the digitizer's front panel display, or turn that display off if desired (see “[Display Features](#)” on page 202 for a description of those functions and a summary of messages which may be displayed on the front panel during routine operation).
- A routine instrument self-test when you cycle power to the digitizer. You can perform a more complete self-test using *TST (see “[Self Test](#)” on page 205).
- You can perform either a routine autozero calibration of the digitizer or a complete instrument calibration (see “[Calibration](#)” on page 207).
- You can query the digitizer's operational status and instrument error conditions helpful in troubleshooting (see “[Instrument Conditions](#)” on page 208).
- You can put the input channels in a “safe” state to protect the digitizer from unexpected power loss or voltage transients (see “[Safe State](#)” on page 208).
- You can secure the digitizer, clearing all instrument states and sample memory, if you need to remove the digitizer from a secure area (see “[Secure State](#)” on page 209).
- You can update the digitizer's firmware. For the latest firmware, go to the product page at: www.agilent.com/find/L4532A.

Configured Instrument States

Parameter Default Values

The following tables show the factory default values for user-configurable digitizer parameters. LAN configuration parameters marked with an asterisk (*) are stored in non-volatile memory; they are not affected upon cycling power to the digitizer or sending the system reset (*RST) command. For those parameters, the initial factory settings are shown under **Default Value**. LAN configuration changes take place only after a PC or digitizer reboot.

All other user-defined parameters are stored in volatile memory; they are reset to the state listed under **Power-On/Reset Value** upon cycling power to the digitizer or sending the system reset (*RST) command.

The *SAV and *RCL commands allow you to save all volatile parameters in one of five memory states (see “[Saving an Instrument Configuration State](#)” on page 201 and “[Recalling a Saved Instrument Configuration State](#)” on page 201).

Command	Parameter Name	Default Value
SYSTem:COMMunicate:LAN:DHCP	<mode>*	enabled (ON 1)
SYSTem:COMMunicate:LAN:DNS	<address>*	0.0.0.0
SYSTem:COMMunicate :LAN:DOMain	<name>*	no name assigned
SYSTem:COMMunicate :LAN:GATEway	<address>*	may be assigned by DHCP
SYSTem:COMMunicate :LAN:HOSTname	<name>*	A-L4532A- <i>nnnnn</i> or A-L4534A- <i>nnnnn</i> , where <i>nnnnn</i> is the last 5 digits in the digitizer's serial number.
SYSTem:COMMunicate :LAN:IPAddress	<address>*	may be assigned by DHCP
SYSTem:COMMunicate :LAN:SMASk	<mask>*	255.255.0.0
SYSTem:COMMunicate :LAN:TELNet:PRoMpt	<string>*	"L4532A>" or "L4534A>" ,depending on model
SYSTem:COMMunicate :LAN:TELNet:WMESsage	<string>*	"Agilent L4532A Instrument" or "Agilent L4534A Instrument", depending on model

Command	Parameter Name	Power-On/Reset State
[CONFigure:]ACQuisition [:ATTRIBUTES]	<sample_rate>	20000000
	<samples_per_record>	2048
	<pre-trig_samples_per_record>	0
	<num_records>	1
	<trigger_holdoff>	0
	<trigger_delay>	0
[CONFigure:]ARM:SOURce	<source>	IMMediate
	<triggers>	1024
[CONFigure:]ARM:SOURce:TIMER	<seconds>	0
[CONFigure:]CHANnel [:ATTRIBUTES]	<chan_list>	no chan assigned
	<range>	256
	<coupling>	DC
	<filter>	LP_20_MHZ
[CONFigure:]CHANnel:PROtection	<chan_list>	no chan assigned
	<mode>	OFF
[CONFigure:]EXTErnal[:INPut]	<slope>	POSitive
[CONFigure:]EXTErnal:TRIGger:OUTPut	<event>	NONE
	<drive_mode>	OFF
[CONFigure:]TRIGger:SOURce	<source>	IMMediate
[CONFigure:]TRIGger:SOURce:CHANnel:EDGE	<chan_list>	no chan assigned
	<level>	0
	<slope>	POSitive
	<hysteresis>	2% of range
[CONFigure:]TRIGger:SOURce:CHANnel:OFF	<chan_list>	no chan assigned
[CONFigure:]TRIGger:SOURce:CHANnel:WINDow	<chan_list>	no chan assigned
	<level_lo>	0
	<level_hi>	0
	<hysteresis>	2% of range
	<direction>	ENTering
[CONFigure:]TRIGger:TIMEstamp[:MODE]	<counter_mode>	INITiate
DISPLay:TEXT	<string>	no text assigned

Command	Parameter Name	Power-On / Reset Value
FORMat:BORDER:	<mode>	NORMAL
FORMat:DATA:REAL:	<format>	REAL
	<length>	32
FORMat:DATA:INTEger:	<format>	INTEger
	<length>	16
MEASure:THResholds:ABSolute	<chan_list>	no chan assigned
	<vHigh>	+1.0 V
	<vMid>	0 V
	<VLow>	-1.0 V
MEASure:THResholds:METHod	<chan_list>	no chan assigned
	<method>	PERCent
MEASure:THResholds:Percent	<chan_list>	no chan assigned
	<%High>	90
	<%Mid>	50
	<%Low>	10
MEASure:THResholds:TOPBase:ABSolute	<vTop>	+1.0 V
	<vBase>	-1.0 V
MEASure:THResholds:TOPBase:Method	<chan_list>	no chan assigned
	<method>	STANDARD
MEASure:WINDow[:DEFine]	<num_record>	no rec assigned
	<start_offset>	0 (at trigger)
	<size>	0 (OBM off)

Saving an Instrument Configuration State

The digitizer has five locations in which you can store *instrument configuration states*. Do not confuse these with *digitizer operating states* (such as Idle, Wait for Arm, Wait For Trigger). Instrument configuration states include all parameters you set with the CONFIGURATION commands. This feature allows you to easily recall all settings in a saved state, but does not save sample data or derived measurement data.

To store an instrument configuration state, use this command:

```
*SAV <location>
```

<location> is the location in which you chose to store the current instrument configuration state: 0, 1, 2, 3, or 4.

Example: The following command stores the current instrument state in location #3:

```
*SAV 3
```

Recalling a Saved Instrument Configuration State

The digitizer has five locations from which you can retrieve a saved instrument configuration state. This feature allows you to easily recall all settings in a saved state, but does not save sample data or derived measurement data.

To recall a saved instrument state, use this command:

```
*RCL <location>
```

<location> is the location in which you stored a configured instrument state: 0, 1, 2, 3, or 4.

Example: The following command recalls the instrument configuration state stored in location #2 and sets all affected parameters to the stored values.

```
*RCL 2
```

Display Features

The backlit front-panel LCD display provides two lines which can display 16 characters each.

Top Display Line

The top line displays the instrument state:

- **IDLE** – the digitizer is currently not busy.
- **WFA** – The digitizer has been INITiated and is waiting for arm.
- **WFT**– The digitizer is armed and waiting for trigger.
- **ACQUIRING** – The digitizer has seen its trigger event and is currently measuring on one or more of the inputs.
- **Measuring** – The digitizer is evaluating an on-board measurement.
- **DTR** – The digitizer is transferring data.
- **SYSTEM ERROR**– The digitizer detected a hardware error on startup.
- **Testing ...** – A self test is currently being performed.
- **Calibrating** – Calibration is currently being performed.
- **Updating** – A firmware update is in progress.
- **Rebooting** – New firmware has been installed, and the digitizer is rebooting to complete the update.

In normal operation, the rightmost three characters of the top line are reserved for annunciators:

- The last character will be for errors. If there is an error for any of the server applications, the error annunciator **E** will be displayed. When the error is cleared, the **E** will be cleared as well. If a LXI LAN fault occurs, there will be an asterisk on the bottom display line below the error annunciator, as shown: **E**

- The second from the last character will be the LAN activity indicator, **L**. If there have been LAN commands or queries, the **L** will be displayed for a few seconds and then cleared.
- The third from the last character will be the USB activity indicator, **U**. If there have been USB commands or queries, the **U** will be displayed for a few seconds and then cleared.

During firmware updates the top line of the display displays **Updating**, and the bottom line displays progress messages. These provide feedback that the digitizer has not stopped the update process, since firmware updates may take several minutes.

Bottom Display Line

The bottom line displays LXI/LAN information. LXI always has precedence over LAN information. For example if the LXI Identification is sent to an instrument it must be displayed instead of any LAN information.

If LXI information is displayed: these are the possible messages:

- **LXI-Power** - The backlight of the display will indicate that the power is on.
- **LXI-IDENT** - A request for LXI instrument identification has been sent to the digitizer. A subsequent request must be sent to disable this message.
- ***** - LXI LAN fault indicator.

If LAN information is displayed: it is the current IP Address.

If a firmware update is in progress: progress messages are displayed.

Displaying Custom Text

As part of a command sequence or while troubleshooting, it may be helpful to be able to display a custom text line on the digitizer's front panel. To display a custom message on the front panel, use this command:

```
DISPlay:TEXT <string>
```

<string> is the text you wish to display. Specify any ASCII characters (lower or upper case letters, symbols, or numbers), limited to 12 characters. You must enclose the string in quotes. The default is an empty string.

Example: The following command displays the message "Unit Failure" on the display.

```
DISP:TEXT "Unit Failure"
```

Turning the Display Off (or back On)

To turn the front panel display off or on, use this command:

```
DISPlay [:STATe] <state>
```

<state> is the display state: OFF, ON (default).

Example: The following command turns the display off.

```
DISP:STAT ON
```

Potential Display Problems

NOTE

Electrostatic discharge (ESD) may cause a temporary display failure, requiring you to cycle power to the digitizer to restore display function.

Occasionally, an ESD event may cause a temporary failure or lockup of the front-panel display. This has no effect on data integrity or on digitizer operation other than the display. The digitizer will continue to collect, process, and transfer data normally.

The display lockup or failure is self correcting on the next power-on cycle. Cycle the power at the next convenient time and the front-panel display will be restored. You may wish to save the configured instrument state (see ["Saving an Instrument Configuration State"](#) on page 201) before cycling power to correct this problem.

Self Test

A brief power-on self-test occurs automatically whenever you cycle power to the digitizer. This limited test assures that the digitizer is capable of operation. If the power-on self-test fails, the  annunciator on the right side of the display turns on once the digitizer enters the Idle state. In that case, you may initiate a more complete self test as described below.

The complete self-test is an automated procedure that systematically exercises the processor, digital infrastructure, memory, and analog front end subsystems. This procedure attempts to isolate any failing conditions found to a particular assembly, to facilitate troubleshooting and repair. The test typically takes approximately 60 seconds to complete. Successful execution of the self-test provides a high degree of confidence that the digitizer is operating normally.

During the test the digitizer analog inputs are disconnected internally from the rear panel BNC connectors and are connected to the internal calibration source. This source is then used to stimulate the analog input channels with test signals. All of the internal signal paths are tested for proper operation. As the different signal paths are configured for testing, the activation of the relays used to switch the signal paths is audible. After the test procedure completes, the analog inputs are re-connected to the rear panel BNC connectors.

The procedure for performing a complete self-test and an explanation of self-test error messages are on [page 206](#).

Self-Test Procedure

- 1 Remove all input connections to the digitizer.
- 2 Running the test from the Web Interface:
 - a Make a connection to the digitizer using the Web Interface (see “[Accessing the Web Interface](#)” on page 24).
 - b Enter the Remote Control Page  and click the **Utilities** tab.
 - c Clear any errors present in the digitizer error queue, as follows: click the View Errors button and answer YES to view and clear any errors.
 - d Click the Run Self-Test button to begin the self test. The self test will take approximately 60 seconds to complete and you may hear the digitizer internal relays switching during the procedure. The front-panel display indicates progress of the test. If the self-test is successful, Self-test Passed is reported. If any self-test fails, Self-Test Failed is reported, and the History dialog box on the control panel page lists error numbers and messages for each failed test.
 - e As in step 2.c, view, note and clear any errors.
- 3 Running the test from I/O Libraries:
 - a Make a connection to the digitizer using the Agilent Connection Expert (see “[Connecting to Your PC](#)” on page 22).
 - b Click the Interactive IO Button to open the command window.
 - c Clear any errors present in the digitizer error queue. Send the SYSTEM:ERROR? query repeatedly to assess what errors were found button and clear all errors.
 - d Send the *TST? query to begin the self test. The self test will take approximately 60 seconds to complete and you may hear the digitizer internal relays switching during the procedure. The query returns +0 to indicate that all tests passed, and +1 if one or more test failed.
 - e As in step 3.c, view, note and clear any errors.

If all tests pass, you have a high confidence that the digitizer is operational.

For a list of the self-test error messages and their meaning, see the *Agilent L4532A/34A Service Guide* or the *Agilent L4532A/34A Command Reference*.

If repair is required, contact an Agilent Service Center.

Calibration

The digitizer should be calibrated on a regular interval determined by the measurement accuracy requirements of your application. Complete instrument calibration procedures are covered in the *Agilent L4532A/34A Service Guide*, and should only be performed by trained personnel.

An auto-zero calibration feature is available to the user, providing a means of improving zero voltage offset calibration before sampling. The procedure is described below.

Auto-Zero Calibration

This command can only be performed when the digitizer is in the Idle state.

To perform a quick auto-zero calibration on specified channels, use this query:

```
CALibration:ZERO:AUTO? (@<chan_list>)
```

This query improves the zero voltage offset calibration by compensating for transient environmental conditions. This enables a user using a high voltage range to obtain highly accurate readings near 0 V, thus allowing for periodic, fast calibrations without calibrating all ranges and filters to zero. The currently configured range, AC/DC coupling, and filter states are unaffected.

The digitizer's software connects the calibration bus for the specified channels. For each channel in the <chan_list>, it performs the zero offset calibration for the existing front end configuration. When the command finishes, it updates active constants that are used as long as the power remains on. It then restores normal input connections to the given channels, and returns a value of 0 if no errors occurred or 1 if errors occurred.

Example: The following command performs an auto-zero on channels 1, 3 and 4.

```
CAL:ZERO:AUTO? (@1,3,4)
```

Instrument Conditions

The digitizer features a comprehensive Status Subsystem to help you monitor its operational status, read and clear system errors, and assist in debugging.

The Status System

Some of the status conditions you can assess include:

- The current operating state of the digitizer
- Questionable events detected, such as:
 - Voltage overload
 - Unlocked phase lock loop
 - Corrupt data detected on one or more channels

A comprehensive treatment of the Status Subsystem, including a system diagram and command syntax for all status queries, can be found in the *Agilent L4532A/34A Command Reference* online help file.

Error Messages

Refer to the *Agilent L4532A/34A Command Reference* for a complete list of error messages and their meaning.

Safe State

You can place the digitizer in a safe state if you intend to leave input signals connected to the input BNCs while unattended. Use the following command to disconnect all input channels from the measurement hardware and reset all channel ranges to 256 V:

```
SYSTEM:PRESet [SAFE]
```

This command performs the same action as pressing the On/Standby switch, but can be used remotely from your host application.

To restore inputs for sampling after sending that command, take one of the following actions:

- Issue the command
CONFigure:CHANnel:PROTection:RELAy (@1:4), OFF
- Issue the *RST command (resets channel inputs as a power-on default)
- Cycle power to the digitizer

Secure State

You can clear sample memory and all digitizers settings except for calibration parameters. This step also clears all user-defined instrument configuration states (see “Configured Instrument States” on page 198).

Use When: Use this feature if you need to remove the digitizer from a secure area. This is not recommended for routine applications

How to Specify: To secure the digitizer, use this command:

```
SYSTEM:SECURITY:IMMEDIATE
```

Web Interface Password: The command above resets the Web Interface password to `agilent`. This is done even if you have not previously set a Web Interface password. You will need to enter this password to access the Web Interface’s **Remote Control** and **Network Configuration** pages.

You have two choices to reset the password:

- You can set a new password using the Web Interface. From the **Network Configuration** page, click the Modify Configuration button.

Parameter	Currently in use
IP Address Configuration:	Automatic
IP Address:	192.168.0.101
Subnet Mask:	255.255.255.0
Default Gateway:	192.168.0.1
DNS Server(s):	192.168.0.1
Desired Hostname	A-L4534A-US114
Domain:	hsd1.co.comcast.net.
Description:	Agilent L4534A Digitizer US114

The following page loads. Check the Set a Password check box, enter and confirm the desired password, and click the Apply button.

Apply Undo Changes LAN Reset Factory Defaults

Note: You must click "Apply" before changes to parameters become effective.

Parameter	Value
IP Address Configuration:	<input checked="" type="radio"/> Automatic <input type="radio"/> Manual
IP Address:	<input type="text"/>
Subnet Mask:	<input type="text"/>
Default Gateway:	<input type="text"/>
DNS Server Address Configuration:	<input checked="" type="radio"/> Automatic <input type="radio"/> Manual
Preferred DNS Server:	<input type="text"/>
Alternate DNS Server:	<input type="text"/>
Desired Hostname:	A-L4534A-US114 (Requires reboot to take effect)
Description:	Agilent L4534A Digitizer US114
Password:	<input type="checkbox"/> Set a Password <input type="text"/> (Enter New password) <input type="text"/> (Confirm New password)

- Pressing the rear panel **LAN reset** button also clears the password.

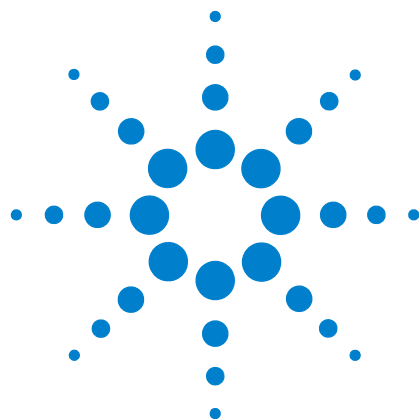

7 Specifications

This chapter provides comprehensive Specifications for the Agilent L4532A/34A digitizers, with firmware revision 1.00 or later installed

Specifications are subject to change without notice. For the latest specifications, see the product datasheet on the Web. Firmware updates may also be available on the Web. Start at the appropriate product page:

www.agilent.com/find/L4532A

www.agilent.com/find/L4534A

This ISM device complies with Canadian ICES-001.

Cet appareil ISM est conforme à la norme NMB-001 du Canada.



N10149

General Specifications	212
Arm and Trigger	213
Sampling	213
DC Accuracy	214
Dynamic Characteristics	215
Timing and synchronization	216
Waveform memory	216
Waveform measurements	216
Utilities	216
Hardware	217
Software	217
Minimum system requirements (I/O Libraries and Drivers)	218
Environmental	218
Data storage/transfer	218
To Calculate Total Measurement Error	219



General Specifications

Maximum Sample Rate	20 MSa/s
Sample Resolution	16 Bits
Input Configuration	Isolated Inputs (each channel independently isolated)
Isolation voltage (low to chassis)	± 40 V
Maximum input (Hi to Low)	± 250 V _{pk} ¹
Maximum Input Range	± 256 V
Input impedance	1 M Ω 40 pF
Input coupling	DC or AC
AC cutoff frequency (-3 dB)	< 10 Hz
Input ranges	±256 V, ±128 V, ±64 V, ±32 V, ±16 V, ±8 V, ±4 V, ±2 V, ±1 V, ±500 mV, ±250 mV
Overvoltage protection	Yes
Maximum Overvoltage Transient	± 400 V _{pk}
Analog bandwidth (-3dB)	20 MHz typical
Noise Filtering (2-pole Bessel)	200 kHz, 2 MHz typical
Power Requirements Line Voltage: Line Frequency: Power Consumption:	100 to 240 VAC (universal) 50 Hz or 60 Hz 45 W (240VA)
EMC Conforms To:	IEC 61326-1:2005-12 (EU) EN 61326-1:2006 ICES-001:2004 (Canada) AS/NZS CISPR 11:2004
Safety Conforms To	IEC/EN 61010-1:2001(EU) CAN/CSA-C22.2 No. 61010-1-04 (Canada) UL 61010-1 (2nd Edition) (US) AS 61010.1:2003 (Australia/New Zealand)

1. CAT 1. IEC measurement category 1. Inputs may be connected only to circuits that are isolated from AC mains.

Arm and Trigger

Each Arm event gates 1 or more trigger events. Each Trigger event causes acquisition of data into a single record at the configured sample rate. The number of data records is configurable from 1 to 1024.

Source	Arm	Trigger	Description
IMMEDIATE	•	•	Trigger or ARM at INIT time
EXTERNAL¹	•	•	BNC TTL input edge (selectable rising/falling edge)
SOFTWARE	•	•	Instrument commands
TIMER	•		0.0 s to 3600.0 s with 50 ns resolution
Channel/Edge		•	Selectable level, rising/falling, hysteresis
Channel/Window		•	Selectable high and low levels, leaving/entering, hysteresis
OR²		•	Logical OR of channel trigger source and EXTERNAL

- EXTERNAL can be used as an ARM source or a Trigger source, but not both at the same time.
- OR can not be used if the EXTERNAL source is being used as an ARM source.

Sampling

Programmable sample rates:	1 KSa/s, 2 KSa/s, 5 KSa/s, 10 KSa/s, 20 KSa/s, 50 KSa/s, 100 KSa/s, 200 KSa/s, 500 KSa/s, 1 MSa/s, 2 MSa/s, 5 MSa/s, 10 MSa/s, 20 MSa/s
External event output: Event Types: Output Signal: ^{1,2} Impedance:	Trigger, end-of-record, end-of-acquisition TTL 25 Ω or 50 Ω
Trigger Modes Pretrigger Posttrigger Timestamp triggered event Timestamp resolution Trigger delay Trigger holdoff Trigger latency ³	0 to "record length - 4" Record length — pretrigger Elapsed time since INIT, or Continuous running timestamp 12.5 ns 0 to 3600 s, with 50 ns resolution 0 to 10 s, with 50 ns resolution 12.5 ns
Trigger reactive Ext input trigger latency Ext output trigger latency	40 ns to 51 ns 4 ns to 21 ns

- Pulse width 1 μs (200 ns for records taking <2 μs to complete).
- TTL output pulse can be configured for either rising or falling edge.
- Latency between Level/window trigger detection and first (trigger) sample.

DC Accuracy

Total Specification (% of reading + % of range)¹

Range	23 °C ±5 °C		T _{autozero} ±3 °C ^{2,3}	Temp coefficient outside 18-28 °C	
	± % of reading	± % of range	± % of range	± % of reading/°C	± % of range/°C
250 mV	0.10	0.30	0.11	0.01	0.015
500 mV	0.10	0.20	0.06	0.01	0.010
4 V, 64 V	0.10	0.30	0.05	0.01	0.015
8 V, 128 V	0.10	0.20	0.04	0.01	0.010
1 V, 2 V, 16 V, 32 V, 256 V	0.10	0.12	0.04	0.01	0.010

1. 100,000 sample average @ 1 MSa/s

2. For 1 V range and greater, typical offset with constant temperature is 0.01% of range.

3. Autozero done at room temperature within 24 hours.

Integral nonlinearity	±5 LSB
Differential nonlinearity	± 1 LSB typical, no missing codes
Input bias current	< 10 nA typical

Dynamic Characteristics¹

Measured using a 65536 point FFT.

Input range 980 kHz input (-1 dBFS)					
	SFDR (dBc)	THD (dBc)	SNR (dB)	SINAD (dB)	ENOB ²
250 mV	71	-79	67	66.7	10.8
500 mV	77	-83	70	69.8	11.3
1 V	81	-85	73	72.7	11.8
2 V	85	-82	75	74.2	12.0
4 V	70	-80	64	63.9	10.3
8 V	70	-83	65	64.9	10.5
16 V	70	-81	65	64.9	10.5
Input range 9.8 MHz input (-1 dBFS)					
250 mV	71	-71	66	64.8	10.5
500 mV	71	-73	68	66.8	10.8
1 V	69	-68	72	66.5	10.8
2 V	63	-62	72	61.6	9.9

1. External timebase measurements made with 1 Vpp sinewave with <2 ps RMS jitter.

2. ENOB = (SINAD - 1.76)/6.02

AC flatness (DC-4 MHz) 250 mV 500 mV, 1 V, 2 V, 4 V, 8 V, 16 V, 32 V 64 V, 128 V, 256 V	± 0.28 dB relative to 1 kHz ± 0.20 dB relative to 1 kHz ± 0.2 dB ±0.01 dB/°C relative to 1 kHz
Crosstalk (Ch to Ch) $R_s = 50 \Omega$	< -90 dB @ 1 MHz

Timing and synchronization

Internal timebase accuracy	±50 ppm
Internal timebase output (clock out BNC) Frequency Level	10 MHz TTL
External timebase reference (clock in BNC) Lock range Clock skew Level Input resistance	10 MHz ±5000 ppm (10 MHz ±50 kHz) ±10 ns (typical) 1 V _{pp} sine wave minimum, with < 2 ps RMS jitter. 100 kΩ nominal

Waveform memory

Data memory Standard ¹ Extended ¹	32 MSa/ch 128 MSa/ch
Random access to readings Multiple record mode	Capture multiple records from multiple triggers

1. Nominal values. Specific sample max is between 33,554,432 and 134,205,440 samples.

Waveform measurements

Voltage	Peak-to-Peak, minimum, maximum, average, RMS, amplitude, base, top, overshoot, preshoot, upper, middle, lower
Time	Rise, Fall, Period, frequency, positive width, negative width, duty cycle

Utilities

Calibration Calibration cycle Internal calibration source Electronic calibration	1 year 0 to ±16V typical Requires an external 6.5 digit DMM and PC
Self test	Power on self test. Complete self test performed using *TST?

Hardware

1U Full rack LXI	425.7 mm W x 44.5 mm H x 367.9 mm D
Weight L4532A (2 channel) L4534A (4 channel)	3.3 kg 3.63 kg
Front Panel	Power switch and display
Back panel (connectors) Power Input Input Channel Cal Src out 10 MHz In 10 MHz Out Trig In/Out I/O Interface	BNC BNC BNC BNC BNC LAN (Gbit), USB 2.0

Software

Web Interface	Internet Explorer, IE (version 6 & 7), Mozilla Firefox and Netscape. Requires Java-enabled browser (Java 1.6 or greater)
Remote programming language	ASCII commands, IEEE 488.2 compliant
Computer interfaces LAN: Standard LAN 10/100/1000 Base Tx USB: Standard USB 2.0	(VXI-11 ¹ compliant), Sockets (service at port 5025), Telnet (Service at port 5024) (USBTMC-488 compliant ²)
Programming via direct native command set VISA I/O control (LAN or USB) LAN sockets control (LAN only)	Agilent I/O Libraries Suite 15.0 recommended <Sockets programming>
Programming via software driver IVI-COM, IVI-C Driver for Windows 2000/XP/Vista G-driver for LabVIEW	
Compatible with programming tools and environments: Agilent VEE Pro, Microsoft Visual Studio.NET, C/C++, Visual Basic 6, National Instruments Test Stand, Measurements Studio, LabWindows/CVI, LabVIEW.	

1. VXI-11 allows transfer of IEEE 488.1 and IEEE 488.2 messages over a TCP/IP network. Supported by Agilent IO Libraries Suite (included).

2. USB Test and Measurement Class (TMC) that communicates over USB, complying with IEEE 488.1 and IEEE 488.2 standards. Supported by Agilent IO Libraries Suite (included).

Minimum system requirements (I/O Libraries and Drivers)

Operating System	Windows XP SP2 (or later) Windows 2000 Pro SP4 (or later)	Windows Vista 32-bit (Home, Basic, Premium, Business, Ultimate, Enterprise)
Processor	450 MHz Pentium II or higher required, 800 MHz recommended	1 GHz 32-bit (x86)
Available Memory	128 MB minimum (256 MB or greater recommended)	512 MB minimum (1 GB recommended)
Available Disk Space	280 MB minimum, 1 GB recommended for Microsoft .NET framework 2.0 65 MB for Agilent IO Libraries Suite	280 MB minimum, 1 GB recommended for Microsoft .NET framework 2.0 65 MB for Agilent IO Libraries Suite
Video	Super VGA (800 X 600) 256 colors or more	Support for DirectX9 graphics with 128 MB graphics memory recommended (Super VGA graphics is supported)
Browser	Microsoft IE 5.01 or greater	Microsoft IE 7 or greater

Environmental

Operating environment	Pollution degree 2, indoors
Operating temperature	0 to 55 °C
Storage temperature	-40 to +70 °C
Warm-up period	< 60 minutes to rated specs
Relative humidity @40 °C	Maximum relative humidity 80% for temperatures up to 31 °C, decreasing linearly to 50 % RH> at 40 °C
Altitude	2000 M

Data storage/transfer

Pre trigger data	Up to full record length - 4 samples
Record length	8 samples to 32 MSa/128 MSa
Post trigger data	4 samples to 128 MSamples
Maximum number of triggers	Number of records (triggers) configurable to 1024 records
Resolution	One sampling interval
Timestamp rollover	> 1.5 years
Maximum data transfer rate from memory	
USB 2.0	8 MB/s
Gbit LAN	15.0 MB/s

To Calculate Total Measurement Error

The digitizer's accuracy specifications are expressed in the form: (% of reading + % of range). In addition to the reading error and range error, you may need to add additional errors for certain operating conditions. Make sure you apply the conditions as described in the footnotes on the specification pages.

If you are operating the digitizer outside the temperature range specified, apply an additional temperature coefficient error.

Understanding the " % of reading " Error The reading error compensates for inaccuracies that are dependent upon the input signal level. The reading error varies according to the input level on the selected range. This error is expressed in percent of reading. The following table shows the reading error applied to the digitizer's ± 8 V input range specification for a nominal operating temperature of $23\text{ }^{\circ}\text{C} \pm 5\text{ }^{\circ}\text{C}$.

Range	Input Level	Reading Error (% of reading)	Reading Error (Voltage)
± 8 V	8 VDC	0.1	± 8 mV
± 8 V	4 VDC	0.1	± 4 mV
± 8 V	1 VDC	0.1	± 1 mV

Understanding the " % of range " Error The range error compensates for inaccuracies that result from the range you select. The range error contributes a constant error, expressed as a percent of range, independent of the input signal level. The following table shows the range error applied to the digitizer's ± 8 V input range specification for a nominal operating temperature of $23\text{ }^{\circ}\text{C} \pm 5\text{ }^{\circ}\text{C}$.

Range	Input Level	Range Error (% of range)	Range Error (Voltage)
± 8 V	8 VDC	0.20	± 16 mV
± 8 V	4 VDC	0.20	± 16 mV
± 8 V	1 VDC	0.20	± 16 mV

Temperature Coefficients Accuracy is usually specified at the calibration temperature $23\text{ }^{\circ}\text{C} \pm 5\text{ }^{\circ}\text{C}$ temperature range. This is a common temperature range for many operating environments. You must add additional temperature coefficient errors to the accuracy specification if you are operating the digitizer outside the $\pm 5\text{ }^{\circ}\text{C}$ temperature range (the specification is per $^{\circ}\text{C}$).

Index

Symbols

"OR" triggering, 119

A

ABORt command, 92, 95, 96, 97, 98, 99, 100, 101, 159, 164
 AC coupling, 109
 accepting an external trigger pulse, 154
 accessing the web interface, 23
 accuracy specification explained, 219
 acquisition data overview, 164
 acquisition errors, 166
 acquisition preamble, 164
 ADC16 format, 128
 Agilent Connection Expert, 22
 Agilent IO Libraries Suite, 22
 applying power, 18
 arm source, 111, 149
 arm timer, 113, 149
 Arming, 8
 arm source, 111
 arming using a software command, 112
 arming using an arm timer, 113
 external arming, 112
 immediate arming, 111
 overview, 111
 specifications, 213
 arming the digitizer, 111
 ASCII parameters, 70
 auto-zero calibration, 207
 AVERage decimation, 139

B

Big-Endian format, 134
 block header, 141
 BNC cables, 20
 Boolean parameters, 70
 boot sequence, 19
 byte order specification, 134

C

calculating time-based measurements, 174
 calculating voltage levels, 172
 calibration, 207
 calibration cycle, 216
 calibration requirements, 216
 channel connections, 5
 channel errors, 166
 channel input protection, 110
 channel lists, 71
 channel parameters, 71
 channel trigger mode, 153
 channel triggering, 116, 117, 153

Command language
 channel parameters, 71
 command terminators, 72
 IEEE-488.2 common commands, 72
 introduction, 68
 parameter types, 70
 queries conventions, 71
 syntax conventions, 69
 tree system, 68
 VERBose queries, 72
 command monitor, 57
 command terminators, 72
 communicating over the LAN, 88
 communication connections, 5
 completion event, 155
 configuring multiple digitizers, 63
 configuring the digitizer, 102, 103, 146
 connecting over LAN, 75
 connecting over USB, 75
 connecting the digitizer to your computer, 22, 75
 Connections
 channel connections, 5
 communication connections, 5
 control connections, 5
 control connections, 5
 coupling, 109
 custom display messages, 204

D

data block structure, 142
 DATA decimation, 138
 Data Formats
 ADC16, 128
 Integer ADC16, 129
 Integer ASCII, 130
 Real 32, 131
 Real 64, 132
 Real ASCII, 133
 specifying byte order, 134
 data records, 103
 Data Retrieval, 127
 acquisition data overview, 164
 acquisition error data, 166
 ADC code data return, 162
 AVERage decimation, 139
 block header, 141
 block structure, 142
 DATA decimation, 138
 data retrieval process outline, 159
 examples, 137
 examples using decimation, 138
 FETCh and READ queries, 135
 from the web interface, 143
 MINMax decimation, 140
 parameter choices, 136
 record summary, 164
 record timestamps, 165
 record-specific data overview, 165
 the FETCh command subsystem, 161
 the READ command subsystem, 167
 use model, 159
 voltage data return, 163
 data storage, 218
 DC accuracy, 214
 DC coupling, 109
 decimation, 138
 Default Gateway, 81
 defining installed measurements, 194
 deleting installed measurements, 196
 device under test, 20
 DHCP, 78
 Digitizer Configuration, 102, 146
 arm signal slope, 149
 channel attributes, 108, 147
 channel triggering, 153
 data records, 103
 edge trigger attributes, 151
 enabling input protection, 147
 external trigger connector, 154
 input pulse specifications, 154
 low-pass filter, 109
 number of arm triggers per arm, 105
 number of records per acquisition, 105
 output pulse specifications, 154
 overvoltage protection, 110
 sample rate, 106
 sampling and record storage attributes, 148
 selecting the trigger source, 150
 signal coupling, 109
 trigger out attributes, 155
 trigger signal slope, 150
 trigger timestamp mode, 157
 voltage range, 108
 window trigger attributes, 152
 digitizer states, 90
 disabling the front panel display, 204
 discrete parameters, 70
 Display, 4, 202
 bottom line messages, 203
 displaying custom text, 204
 top line messages, 202
 turning on and off, 204
 DNS Server address, 79
 Domain Name, 80
 dynamic characteristics, 215
 dynamic IP address, 78

E

edge triggering, 116, 151
 environmental considerations, 13, 218
 error messages, 208
 Examples
 digitizing a sine wave, 34

Index

digitizing a solenoid output, 47
digitizing multiple simultaneous signals, 62
 using the Web Interface, 34, 47
EXT Trig In/Out connector, 112
external arming, 112, 149
external clock reference, 63, 216
external signal slope, 149, 150
external trigger connector, 154
external triggering, 115, 150

F

FAL:TIME defined, 176
FALL:DUTYcycle defined, 177
FALL:FREQuency defined, 177
FALL:OVERshoot defined, 178
FALL:PERiod defined, 177
FALL:PREshoot defined, 179
falling edge illustrated, 174
FETCh queries, 135, 161
filter, 109
floating inputs, 20
front panel display, 4, 202, 203
front panel illustration, 4
Functional Overview, 6
 arming and triggering, 8
 digitizer operating states, 7
 general operation, 6
 general workflow, 9
 programming, 6

G

general capabilities, 2
general specifications, 212
general workflow, 9

H

high voltage hazards, 21
histogram, 171
Host Name, 82

I

IEEE-488.2 common commands, 72
Illustrations
 front panel, 4
 rear panel, 5
immediate arming, 111
immediate triggering, 114
implicit trigger holdoff, 125
input characteristics, 20
input protection, 147
input pulse specifications, 154
installed measurements, 194
instrument calibration, 207
instrument rack mounting, 14
Instrument States, 198
 defaults, 198
 recalling, 201

 saving, 201
instrument status, 208
Integer ADC16 format, 129
Integer ASCII format, 130
IP Address, 83
isolated LAN networks, 76
items supplied, 12

L

L4532-67001 rack mount kit, 14
LAN
 dynamic IP address, 78
 interface configuration, 77
 network selection, 76, 77
 private LAN considerations, 76
 site LAN considerations, 77
LAN communication, 88
LAN Configuration, 77
 Default Gateway, 81
 DHCP, 78
 DNS Server address, 79
 Domain Name, 80
 Host Name, 82
 IP Address, 83
 MAC address, 85
 Socket sessions, 86
 Subnet Mask, 84
 Telnet Prompt, 86
 Telnet Welcome Message, 87
LAN connection, 75
latency, 123
listing installed measurements, 196
Little-Endian format, 134
low-pass filter, 109

M

MAC address, 85
markers, 52
measurement capabilities, 3
measurement error, 219
measurement histogram, 171
Measurement Queries, 72, 187
 FALL:DUTYcycle, 192
 FALL:FREQuency, 191
 FALL:OVERshoot, 192
 FALL:PERiod, 191
 FALL:PREshoot, 193
 FALL:TIME, 190
 list of measurements, 187
 NWIDth, 190
 PWIDth, 190
 RISE:DUTYcycle, 192
 RISE:FREQuency, 191
 RISE:OVERshoot, 192
 RISE:PERiod, 191
 RISE:PREshoot, 193
 RISE:TIME, 190
 VAMPplitude, 188
 VBASe, 188

VLOWer, 189
VMAX, 188
VMIDdle, 189
VMIN, 188
VPP, 188
VRMS, 189
VTOP, 188
VUPPer, 189
measurement windows, 58
memory, 216
MINMax decimation, 140

N

navigating the web interface, 25
network configuration
 private LAN considerations, 76
 site LAN considerations, 77
numeric parameters, 70
NWIDth defined, 175

O

on/stand-by button, 4, 18
On-Board Measurements, 169
 benefits of installing, 170
 defining installed measurements, 194
 deleting installed measurements, 196
 discrete measurements, 58
 FALL:DUTYcycle defined, 177
 FALL:FREQuency defined, 177
 FALL:OVERshoot defined, 178
 FALL:PERiod defined, 177
 FALL:PREshoot defined, 179
 FALL:TIME defined, 176
 how measurements are calculated, 171
 how time-based measurements are
 calculated, 174
 how voltage levels are calculated, 172
 installing, 194
 installing with the Web Interface, 43
 listing installed measurements, 196
 manually specifying threshold values, 180,
 183
 manually specifying top and base
 values, 180, 182
 measurement histogram explained, 171
 measurement markers, 52
 measurement windows, 58
 NWIDth defined, 175
 NWIDth illustrated, 175
 PWIDth defined, 175
 PWIDth illustrated, 175
 querying installed measurement results, 195,
 196
 resetting threshold values to defaults, 186
 resetting top and base values to
 defaults, 186
 RISE:DUTYcycle defined, 177
 RISE:FREQuency defined, 177

RISE:OVERshoot and FALL:OVERshoot illustrated, 178
 RISE:OVERshoot defined, 178
 RISE:PERiod and FALL:PERiod illustrated, 177
 RISE:PERiod defined, 177
 RISE:PREshoot and FALL:PREshoot illustrated, 179
 RISE:PREshoot defined, 179
 RISE:TIME and FALL:TIME illustrated, 176
 RISE:TIME defined, 176
 rising and falling edges illustrated, 174
 setting measurement markers, 52
 specifying a measurement window, 181
 specifying absolute threshold values, 185
 specifying percent threshold values, 184
 VAMPitude and VPP illustrated, 172
 VAMPitude defined, 172
 VBASE defined, 172
 VMAX and VMIN defined, 172
 VMAX and VMIN illustrated, 172
 VPP defined, 172
 VRMS defined, 173
 VTOP and VBASE illustrated, 172
 VTOP defined, 172
 VUPPer, VMIDdle and VLOWer defined, 173
 VUPPer, VMIDdle, and VLOWer illustrated, 173
 output pulse specifications, 154, 155
 overshoot defined, 178
 overshoot illustrated, 178
 overview, 6
 overvoltage protection, 110, 147

P

parameter coercion, 73
 parameter default values, 198
 parameter types, 70
 PC connection, 22
 port termination step, 64
 powering up the digitizer, 18
 power-on sequence, 19
 preshoot defined, 179
 preshoot illustrated, 179
 private LAN networks, 76
 Programming, 68
 channel parameters, 71
 command terminators, 72
 IEEE-488.2 common commands, 72
 introduction, 68
 parameter coercion, 73
 parameter types, 70
 queries, 71
 settings conflicts, 73
 stale data errors, 74
 syntax conventions, 69
 VERBose queries, 72
 protection limits, 20
 protection relay, 110
 pulse triggering, 115
 pulse width illustrated, 175

PWIDth defined, 175

Q

querying installed measurement results, 195, 196
 querying parameter settings, 71

R

rack mount kit, 14
 rack mounting, 14
 range, 108
 READ queries, 135, 167
 Real 32 format, 131
 Real 64 format, 132
 Real ASCII format, 133
 rear panel illustration, 5
 re-arm time, 125
 recalling instrument states, 201
 record preamble, 165
 record storage, 148
 record summary, 164
 record timestamps, 165
 records, 103
 record-specific data, 165
 return data blocks, 142
 return data lists, 142
 RISE:DUTYcycle defined, 177
 RISE:FREQuency defined, 177
 RISE:OVERshoot and FALL:OVERshoot illustrated, 178
 RISE:OVERshoot defined, 178
 RISE:PERiod and FALL:PERiod illustrated, 177
 RISE:PERiod defined, 177
 RISE:PREshoot and FALL:PREshoot illustrated, 179
 RISE:PREshoot defined, 179
 RISE:TIME and FALL:TIME illustrated, 176
 RISE:TIME defined, 176
 rising edge illustrated, 174

S

safety considerations, 13, 21
 safety information, iii
 safety symbols, iv
 sampling, 148
 sampling capabilities, 3
 sampling rate explained, 106
 sampling specifications, 213
 saving data to a file, 41
 saving instrument states, 201
 selecting the arm source, 149
 self-test, 205
 self-test procedure, 206
 settings conflicts, 73
 shock protection, 21
 site LAN networks, 77
 Socket sessions, 88
 software arming, 112

software interfaces, 217
 software triggering, 115
 Specifications, 219
 arming and triggering, 213
 connections, 217
 data storage, 218
 data transfers, 218
 DC accuracy, 214
 dimensions, 217
 dynamic characteristics, 215
 environmental, 218
 general specifications, 212
 hardware, 217
 measurements, 216
 memory, 216
 minimum system requirements, 218
 programming, 217
 sampling, 213
 software interfaces, 217
 timing and synchronization, 216
 utilities, 216
 specifications explained, 219
 stale data errors, 74
 states of the digitizer, 90
 string parameters, 70
 Subnet Mask, 84
 synchronizing multiple digitizers, 65
 synchronous triggering, 63
 syntax rules, 69
 system requirements, 218
 System-Related Operations
 auto-zero calibration, 207
 calibration, 207
 error messages, 208
 self-test, 205, 206
 status system, 208

T

Telnet Prompt, 86
 Telnet sessions, 86, 88
 Telnet Welcome Message, 87
 temperature coefficients (and accuracy), 219
 threshold definitions illustrated, 173
 threshold settings, 180, 183, 184, 185, 186
 threshold values defined, 173
 time-based measurements, 174
 timer arming, 113
 timestamp latency, 123
 timestamps, 157
 TOPBase settings, 180, 182, 186
 trigger delay, 124
 trigger holdoff, 126
 trigger source, 150
 trigger timestamp latency, 123
 trigger timestamps, 157
 Trigger Timing, 120
 immediate triggering, 122
 re-arm time, 125
 timestamp latency, 123
 trigger delay, 124
 trigger holdoff, 125, 126

Index

- Triggering, 8
 - "OR" triggering, 119
 - channel triggering, 116, 117
 - edge triggering, 116
 - external triggering, 115
 - immediate triggering, 114
 - overview, 111
 - specifications, 213
 - trigger source, 114
 - trigger timing, 120
 - triggering using a software command, 115
 - using external or channel signals, 119
 - window triggering, 117
 - using markers, 52
 - using on-board measurements, 43
 - Utilities tab, 26
 - window triggering, 117, 152
 - workflow, 9

U

- USB connection, 75

V

- VAMPitude and VPP illustrated, 172
- VAMPitude defined, 172
- VBASe defined, 172
- VERBoSe queries, 72
- VMAX and VMIN defined, 172
- VMAX and VMIN illustrated, 172
- voltage definitions illustrated, 172
- voltage hazards, 21
- voltage range, 108
- VPP defined, 172
- VRMS defined, 173
- VTOP and VBASE illustrated, 172
- VTOP defined, 172
- VUPPer, VMIDdle and VLOWer defined, 173
- VUPPer, VMIDdle, and VLOWer illustrated, 173

W

- Waste Electrical and Electronic Equipment (WEEE) Directive, ii
- Web Interface
 - accessing, 23
 - Acquire Data tab, 26
 - Acquisition buttons, 29
 - Apply Configuration button, 26, 28
 - changing acquisition and trigger settings, 39
 - changing channel configuration, 38
 - Command Monitor button, 27
 - Command Monitor window, 28, 57
 - Configure Digitizer tab, 26, 27
 - display controls, 36
 - Help button, 25
 - Measurement buttons, 29
 - Measurements tab, 29
 - navigating, 25
 - Network Configuration page, 26
 - Remote Control Page, 26
 - saving acquired data to a file, 41
 - trigger marker, 37
 - Undo Changes button, 26
 - using, 34, 47